

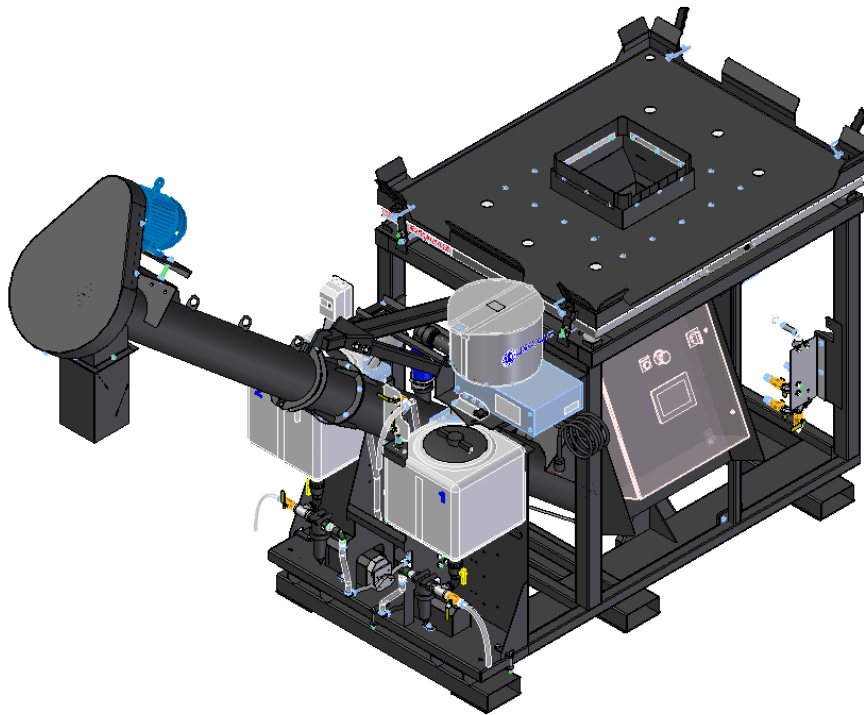

AT500H AUTOMATED TREATER W/LOSS IN WEIGHT SEED METERING



Operators Manual

Software Release: **AT500 v1.02**

Document: **TD-09-06-1054**

Revision: **E**

Effective Date: **Nov. 2021**

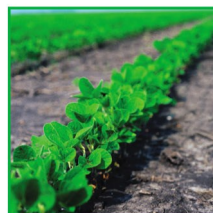

INTRODUCTION

Thank you for choosing USC, LLC for your equipment needs. We appreciate your business and will work diligently to ensure that you are satisfied with your choice.

OVERVIEW

The purpose of this manual is to provide you with the basic information needed to operate and maintain the AT500H Automated Treater. It does not hold USC, LLC liable for any accidents or injuries that may occur.

The technical information provided in this document is based on extensive testing under controlled conditions at the USC research and development facility. This information is given without guarantee as the conditions of operation and storage of the equipment are beyond our control. Variables such as temperature, humidity, viscosity of chemical products and changes in seed size or variety may all effect the accuracy of application and seed coverage. Periodically check the equipment calibration while treating and make adjustments as required. This will insure the optimum seed coverage.

RECEIVING YOUR EQUIPMENT

As soon as the equipment is received, it should be carefully inspected to make certain that it has sustained no damage during shipment and that all items listed on the packing list are accounted for. If there is any damage or shortages, the purchaser must immediately notify USC, LLC. Ownership passes to purchaser when the unit leaves the USC, LLC. premises. The purchaser is responsible for unloading and mounting all components of the equipment.

Document the serial number of the machine for future reference. The serial number is located on the frame above the treater control panel.

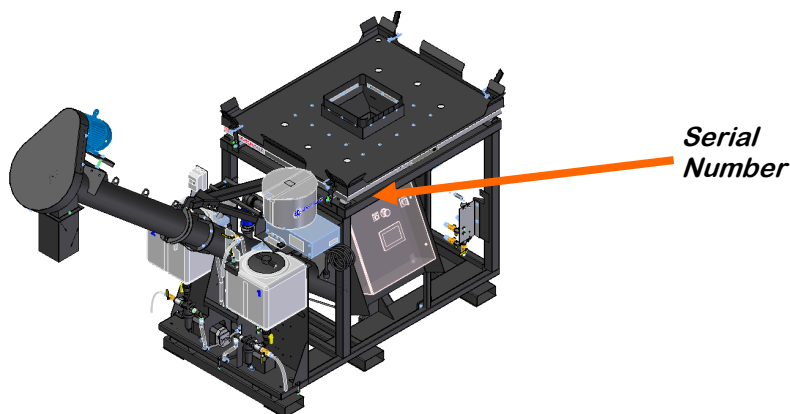

SERIAL NUMBER: _____

TABLE OF CONTENTS

<u>Section</u>	<u>Contents</u>	<u>Page #</u>
Section A	Safety Instructions	4
	Safety Labels	10
Section B	Installation	13
	Main Control Panel Connections	15
Section C	Mechanical Operation	17
	AT500H Automated Treater Overview	17
	Loss In Weight Slide Gate and Atomizer Overview	18
	Peristaltic Pump Head and Motor	19
	Seed Treatment Valves	20
	Flow Meters	21
Section D	Electrical Operation	22
	Startup Screen	22
	Main Screen	24
	H-O-A Screen	29
	Utilities Screen	33
	Reports Screen	36
	Profile Editing Screens	37
	Alarms Screen	46
	Messages	47
Section E	Calibration & Operation	48
	Seed Flow Calibration	48
	Flow Meter Calibration	50
	Treating seed	52
Section F	Troubleshooting	55
	Proximity Sensor Adjustment Guide	58
Section G	Maintenance	59
	Atomizer	60
	Belt Tensioning and Alignment	61
	Belt Tensioning Specification	62
	Pumps—Plumbing-Flow Meter	63
Section H	Storage	65
Section I	Limited Warranty	68

SECTION A SAFETY INSTRUCTIONS

Every year accidents in the work place maim, kill and injure people. Although it may be impossible to prevent all accidents, with the right combination of training, operating practices, safety devices and operator vigilance, the number of accidents can be significantly reduced. The purpose of this section is to educate equipment users about hazards, unsafe practices and recommended hazard avoidance techniques.

SAFETY WORDS AND SYMBOLS

It is very important that operators and maintenance personnel understand the words and symbols that are used to communicate safety information. Safety words, their meaning and format, have been standardized for U.S. manufacturers and published by the American National Standards Institute (ANSI). The European Community (E.C.) has adopted a different format based on the International Standards Organization (I.S.O.) and applicable machinery directives. Both formats are presented below. Graphic symbols are not standardized but most manufacturers will use some variation of the ones seen in this manual.



Indicates an imminently hazardous situation which, if not avoided, **will** result in death or serious injury.



Indicates a potentially hazardous situation which, if not avoided, **could** result in death or serious injury.



Indicates a potentially hazardous situation which, if not avoided, **may** result in minor or moderate injury and/or property damage.



Provides additional information that the operator needs to be aware of to avoid a potentially hazardous situation.



Mandatory Lockout Power Symbol. Disconnect, lockout and tagout electrical and other energy sources before inspecting, cleaning or performing maintenance on this panel.



International Safety Alert Symbol. The exclamation point (!) surrounded by a yellow triangle indicates that an injury hazard exists. However, it does not indicate the seriousness of potential injury. The exclamation point (!) is also used with the DANGER, WARNING and CAUTION symbols so the potential injury is indicated.



Electrocution Hazard Symbol. This symbol indicates that an electrocution hazard exists. Serious injury or death could result from contacting high voltage.



International Electrocution Hazard. This symbol indicates that an electrocution hazard exists. Serious injury or death could result from contacting high voltage.



Mandatory Read Manual Action Symbol. (I.S.O. format) This symbol instructs personnel to read the Operators Manual before servicing or operating the equipment.



Mandatory Read Manual Action Symbol. This symbol instructs personnel to read the Operators Manual before servicing or operating the equipment.

Notice is used to notify people of important installation, operation or maintenance information which is not hazard related.

NOTICE

LOCKOUT / TAGOUT PROCEDURES

Lockout/Tagout is the placement of a lock/tag on an energy isolating device in accordance with an established procedure. When taking equipment out of service to perform maintenance or repair work, always follow the lockout/tagout procedures as outlined in OSHA Standard 1910.147. This standard “requires employers to establish a program and utilize procedures for affixing appropriate lockout devices or tagout devices to energy isolating devices and to otherwise disable machines or equipment to prevent unexpected energizing, start-up, or release of stored energy in order to prevent injury to employees.”

HAZARD REVIEW

Electrocution Hazard



Electrocution accidents are most likely to occur during maintenance of the electrical system or when working on or near exposed high voltage wiring. This hazard does not exist when the electrical power has been disconnected, properly locked, and tagged out.

Automatic Start Hazard



This equipment may be controlled by an automated system and may start without warning. Failure to properly disconnect, lockout, and tagout all energy sources of remotely controlled equipment creates a very hazardous situation and could cause injury or even death. PLEASE STAY CLEAR AND BE ALERT.

YOU are responsible for the **SAFE** operation and maintenance of your USC, LLC equipment . **YOU** must ensure that you and anyone else who is going to operate, maintain or work around the equipment be familiar with the operating and maintenance procedures and related **SAFETY** information contained in this manual. This manual will take you step-by-step through your working day and alert you to good safety practices that should be adhered to while operating the equipment

Remember, **YOU** are the key to safety. Good safety practices not only protect you, but also the people around you. Make these practices a working part of your safety program. Be certain that **EVERYONE** operating this equipment is familiar with the recommended operating and maintenance procedures and follows all the safety precautions. Most accidents can be prevented. Do not risk injury or death by ignoring good safety practices.

- Equipment owners must give operating instructions to operators or employees before allowing them to operate the machine, and at least annually thereafter per OSHA (Occupational Safety and Health Administration) regulation 1928.57.
- The most important safety device on this equipment is a **SAFE** operator. It is the operator's responsibility to read and understand **ALL** Safety and Operating instructions in the manual and to follow them. All accidents can be avoided.
- A person who has not read and understood all operating and safety instructions is not qualified to operate the machine. An untrained operator exposes himself and bystanders to possible serious injury or death.
- Do not modify the equipment in any way. Unauthorized modification may impair the function and/or safety and could affect the life of the equipment.
- Think **SAFETY!** Work **SAFELY!**

GENERAL SAFETY

1. Read and understand the operator's manual and all safety labels before operating, maintaining, adjusting or unplugging the equipment .
2. Only trained persons shall operate the equipment . An untrained operator is not qualified to operate the machine.
3. Have a first-aid kit available for use should the need arise, and know how to use it.



AT500H TREATER

4. Provide a fire extinguisher for use in case of an accident. Store in a highly visible place.
5. Do not allow children, spectators or bystanders within hazard area of machine.
6. Wear appropriate protective gear. This includes but is not limited to:
 - A hard hat
 - Protective shoes with slip resistant soles
 - Protective goggles
 - Heavy gloves
 - Hearing protection
 - Respirator or filter mask
7. Place all controls in neutral or off, stop motor, and wait for all moving parts to stop. Then disable power source before servicing, adjusting, repairing, or unplugging.
8. Review safety related items annually with all personnel who will be operating or maintaining the equipment.



OPERATING SAFETY:

1. Read and understand the operator's manual and all safety labels before using.
2. Disconnect and disable electrical supply completely and wait for all moving parts to stop before servicing, adjusting, repairing or unplugging.
3. Clear the area of bystanders, especially children, before starting.
4. Be familiar with the machine hazard area. If anyone enters hazard area, shut down machine immediately. Clear the area before restarting.
5. Keep hands, feet, hair and clothing away from all moving and/or rotating parts.
6. Stay away from overhead obstructions and power lines during operation and transporting. Electrocution can occur without direct contact.
7. Do not operate machine when any guards are removed.
8. Inspect welds and repair if needed.

PLACEMENT SAFETY

1. Move only with the appropriate equipment
2. Stay away from overhead power lines when moving equipment. Electrocutation can occur without direct contact.
3. Be familiar with machine hazard area. If anyone enters hazard areas, shut down machine immediately. Clear the area before restarting.
4. Operate the equipment on level ground free of debris. Anchor the equipment to prevent tipping or upending.



Before placement of the equipment , be sure that ground is reasonably level. The equipment may topple or work improperly if the ground is too uneven, damaging the equipment and/or causing personal injury.

MAINTENANCE SAFETY

1. Review the operator's manual and all safety items before working with, maintaining or operating the equipment .
2. Place all controls in neutral or off, stop motors, disable power source, and wait for all moving parts to stop before servicing, adjusting, repairing or unplugging.
3. Follow good shop practices:
Keep service area clean and dry.
Be sure electrical outlets and tools are properly grounded.
Use adequate light for the job at hand.
4. Keep hands, feet, hair and clothing away from all moving and/or rotating parts.
5. Clear the area of bystanders, especially children, when carrying out any maintenance and repairs or making any adjustments.
6. Before resuming work, install and secure all guards when maintenance work is completed.
7. Keep safety labels clean. Replace any sign that is damaged or not clearly visible.



SAFETY LABELS

1. Keep safety labels clean and legible at all times.
2. Replace safety labels that are missing or have become illegible.
3. Replaced parts that displayed a safety label should also display the current label.
4. Replacement safety labels are available. Contact your authorized dealer

How to Install Safety Labels:

- Be sure that the installation area is clean and dry.
- Be sure temperature is above 50°F (10°C).
- Decide on the exact position before you remove the backing paper.
- Remove the smallest portion of the split backing paper.
- Align the sign over the specified area and carefully press the small portion with the exposed sticky backing in place.
- Slowly peel back the remaining paper and carefully smooth the remaining portion of the sign in place.
- Small air pockets can be pierced with a pin and smoothed out using the piece of sign backing paper.



Located on the USC equipment you will find safety labels. Always be sure to read and follow all directions on the labels.



Guards provided with USC equipment are to remain in place during operation.

Think **SAFETY!** Work **SAFELY!**

REMEMBER—If safety labels have been damaged, removed, become illegible, or parts replaced without safety labels, new labels must be applied. New safety labels are available from your authorized dealer.



Part # 09-02-0002



Part # 09-02-0003

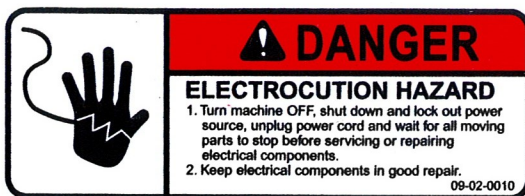

Part # 09-02-0010

AT500H TREATER



Part # 09-02-0001

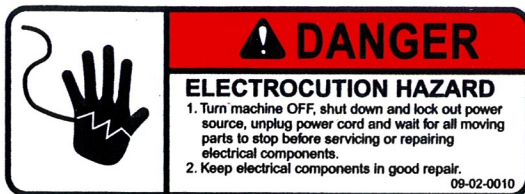
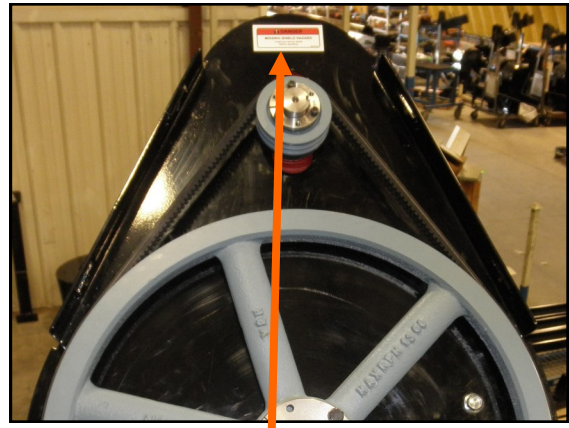

Part # 09-02-0010



Part # 09-02-0012

INSTALLATION

SECTION B



HIGH VOLTAGE ~ Always disconnect the power source before working on or near the control panel or lead wires.



HIGH VOLTAGE ~ Use insulated tools when making adjustments while the controls are under power.

NOTICE

Permanent installation may require additional electrical cords, chemical tubing, and air lines, since each installation is unique.

SET-UP

The following steps outline the initial set-up of your USC AT500H Treater :

1. Clear the area of bystanders, especially small children, before moving.
2. Be sure there is enough clearance from overhead obstructions and power lines or other equipment to move the machine into its working position.
3. Using a forklift, place the AT500H Treater in the desired position on a level surface.

NOTICE

USC highly recommends that the AT500H Treater be set up inside a building or any covered structure to protect the machine from weathering.

4. Inspect AT500 Treater thoroughly for screws, bolts, fittings, etc. which may have come loose during shipping.
5. Check and tighten hose connections.

AT500H TREATER

Sample Label →

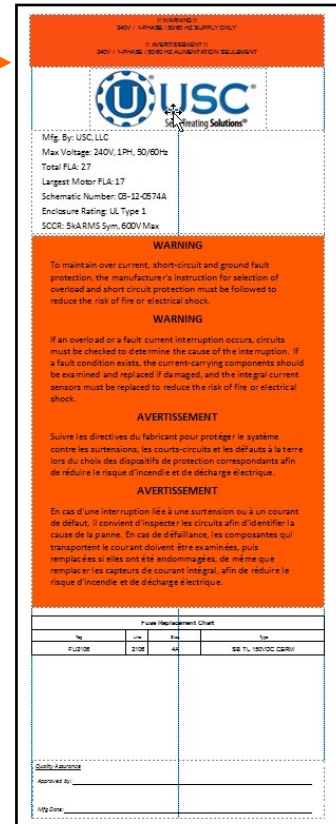

- Have a certified electrician provide power to the seed treating system. Provide convenient shutdown switches, comply with local electrical codes and ensure that the system is properly grounded and bonded. All USC control panels must be connected adhering to the same electrical requirements as specified in the main control panel on the power requirement tag (right), or the electrical schematic shipped with the piece of equipment. This will power the USC AT500H seed treater and any attached conveyors.

Incoming power connected to these terminals in the Treater Control Panel →

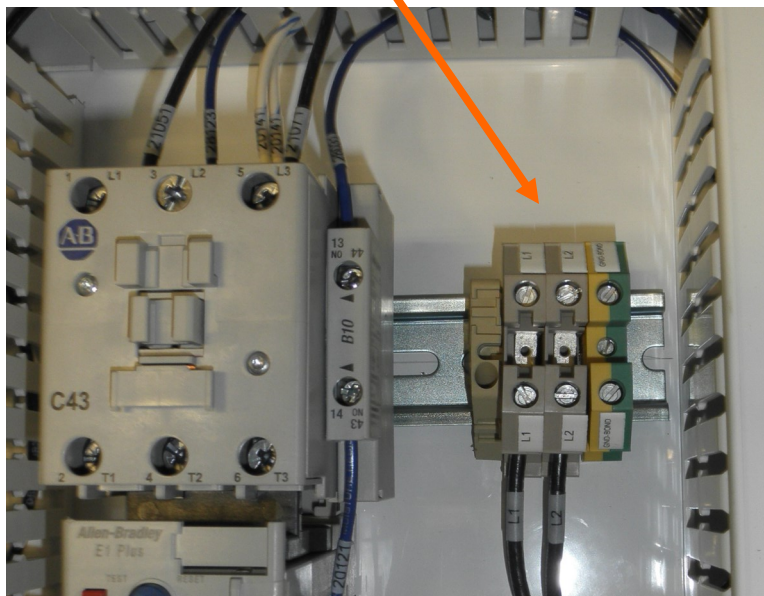

AT500H TREATER

MAIN CONTROL PANEL CONNECTIONS

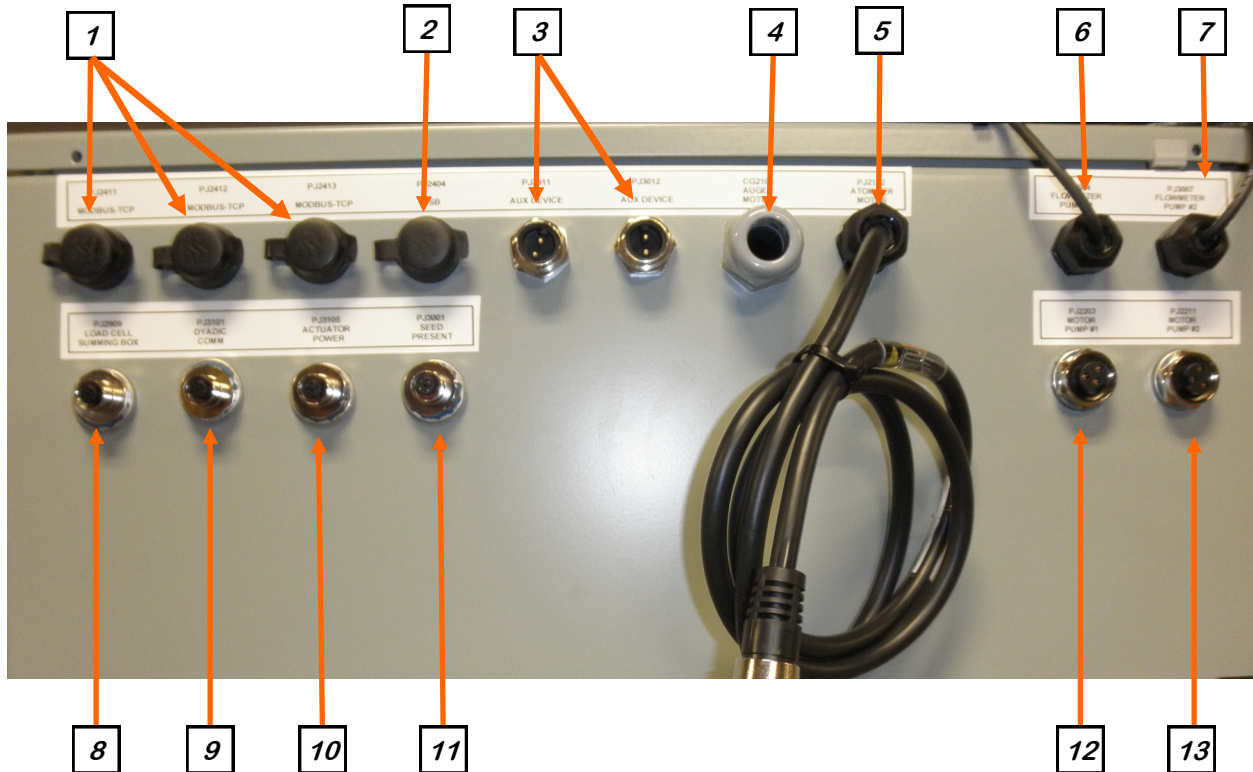

1. There are three MODBUS TCP Ethernet connectors on the Control Panel. These are used as a wireless access point for tablet control and U-Connect Pro to connect to the panel.
2. Use the USB port to plug in a compact flash device. This will be used to export reports from the system.
3. Connect the cable from any additional individually controlled pump stands to either of the two wire connectors PJ2111 Aux Device or PJ2112 Aux Device.
4. Auger motor power cord. This is factory connected.
5. Connect the Atomizer Motor cable from treater panel to the atomizer motor. This is factory connected.
6. Connect the cable from the #1 pump motor to the Motor Pump #1 connector. The number one pump is the one closest to the control panel. This is factory connected.
7. Connect the cable from the #2 Pump Motor to the Motor Pump #2 connector. The number two pump is the one farthest from the control panel. This is factory connected.
8. Connect the cable from the load cell junction box to the Load Cell Summing Box

MAIN CONTROL PANEL CONNECTIONS

connector. This is factory connected.

9. Connect the 8 pin communication cable from the dyadic actuator to the Actuator Comm connector. This is factory connected.
10. Connect the 4 pin power cable from the dyadic actuator to the Dyadic Power connector. This is factory connected.
11. Connect the cable from proximity sensor mounted above the Loss In Weight actuator gate to the Seed Present connector. This is factory connected.
12. Connect the cable from the #1 pump motor to the Motor Pump #1 connector. The number one pump is the one closest to the control panel. This is factory connected.
13. Connect the cable from the #2 Pump Motor to the Motor Pump #2 connector. The number two pump is the one farthest from the control panel. This is factory connected.

MECHANICAL OPERATION SECTION C

AT500H AUTOMATED TREATER OVERVIEW

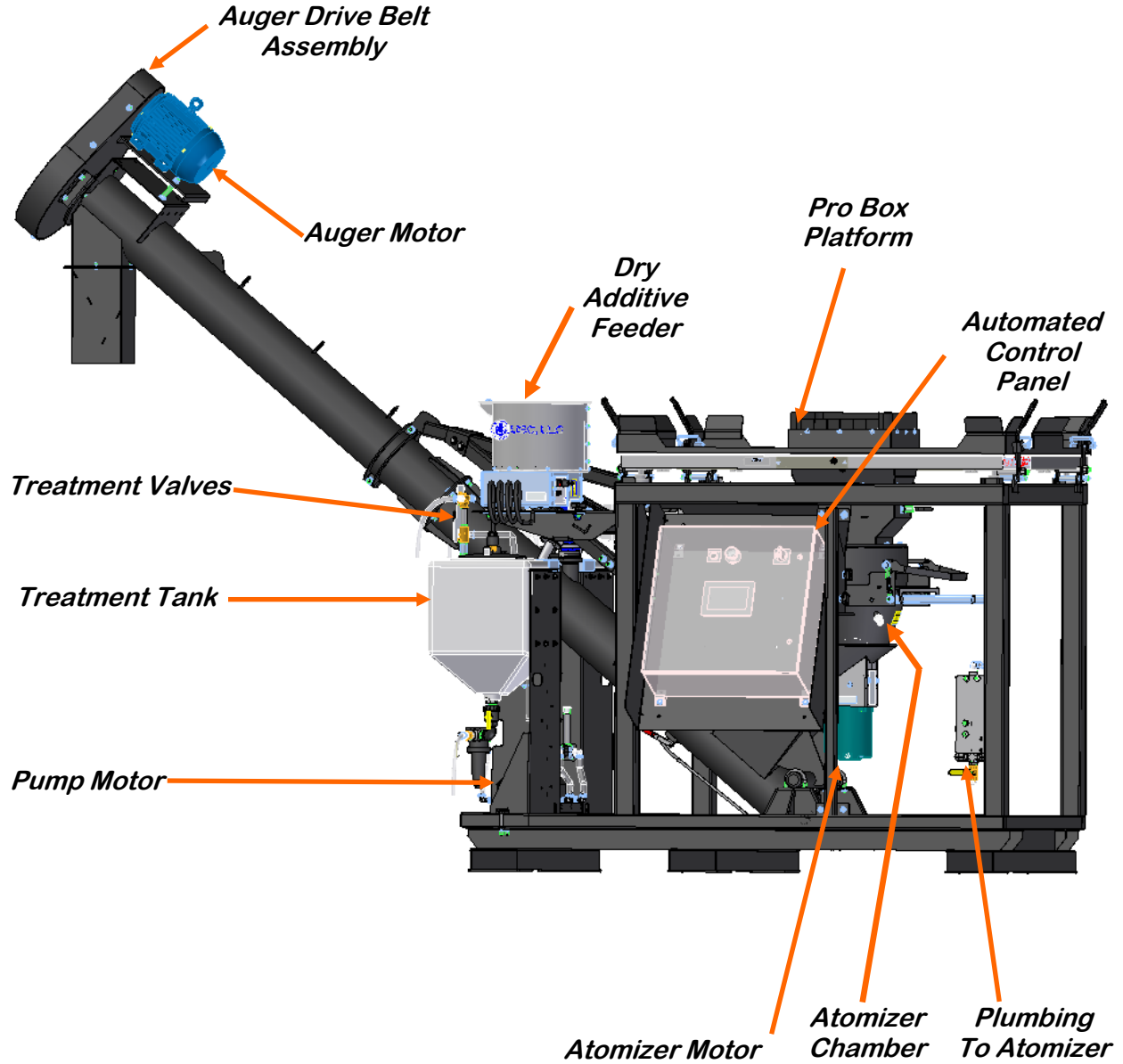

LOSS IN WEIGHT SLIDE GATE AND ATOMIZER CHAMBER

The atomizer chamber consists of a patented design which disperses treatment evenly to each seed. A motor drives the atomizer head at approximately 1725 RPM's. As treatment is being pumped into the atomizer chamber, it drops into the atomizer head. The centrifugal force of the spinning head forces the treatment to be sprayed out through a screen covering in all 360 degrees. Meanwhile, seed flows down out of the box, through the seed gate and down on top of the distribution cone which disperses the seed down around the atomizer head. The atomizer can be easily accessed for cleaning and maintenance by pulling down on the quick release handle and sliding the atomizer away from the treater body (see page 60).

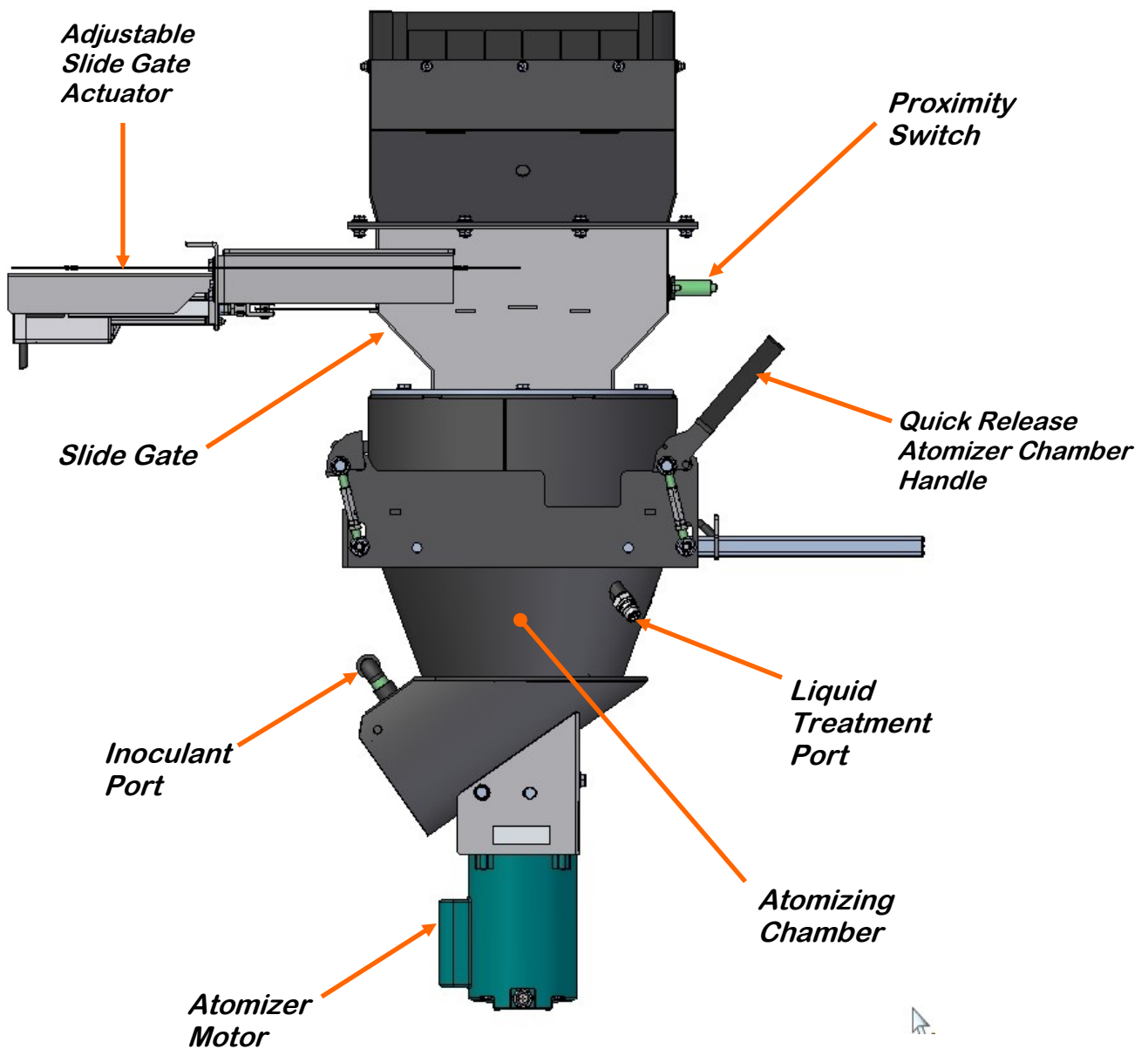

PERISTALTIC PUMP HEAD AND MOTOR

The pump stand utilizes a variable speed pump motor and special noprrene pump tubing for liquid metering. Each pump comes equipped with 1 peristaltic pump head. Liquid will only come into contact with the inside diameter of the pump tubing and not the pump. This allows for easy cleanup and less maintenance of the pump.

To open the pump head, rotate the lever to the left. Place the pump tubing inside the pump head so it fits inside the notches and above the rollers (bottom, left). Rotate the lever back to the right and close the pump head, clamping the hose inside the head (bottom, right). Wear or fatiguing of the tubing within the pump head due to compression is normal. When tubing becomes worn or chemical rates begin to slow down, open the pump head and move the tubing to a different position. If the entire piece of tubing becomes worn, simply replace with a new section. When not using the pump stand for several days or when storing, open the pump head and remove the tubing to prevent any extra compression.



Pump Head Open

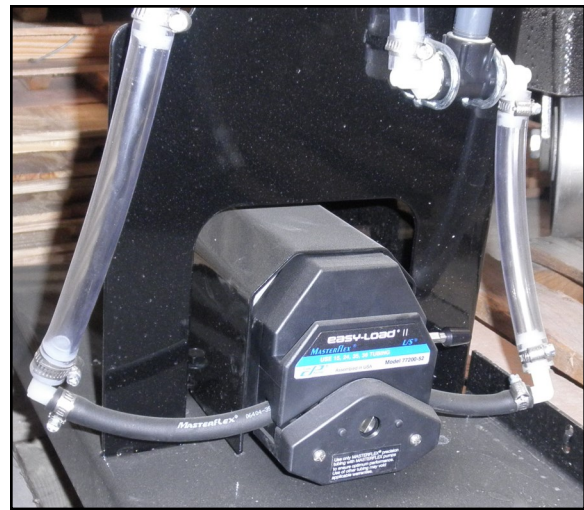

Pump Head Closed

SEED TREATMENT VALVES

SEED TREATMENT VALVES (Left Pump Stand): When the handle of the bottom valve is in the horizontal position the liquid recirculates back into the top of the tank. In the vertical position it sends the liquid up to the top valve.

When the handle of the top valve is in the horizontal position the liquid is directed to the short, unconnected tube so the liquid may flow into a measuring container for pump calibration purposes. In the vertical position it sends the liquid to the treater.

SEED TREATMENT VALVES (Right Pump Stand): When the handle of the bottom valve is in the vertical position the liquid recirculates back into the top of the tank. In the horizontal position it sends the liquid up to the top valve.

When the handle of the top valve is in the horizontal position the liquid is directed to the short, unconnected tube so the liquid may flow into a measuring container for pump calibration purposes. In the vertical position it sends the liquid to the treater.



Left Tank Source Valve



Right Tank Source Valve

FLOW METERS

The pump stands are equipped with volumetric flow meters. A flow meter is used to perform real - time chemical flow adjustments and monitoring without the operator having to handle the chemical. The flow meter reading will be displayed on the HMI touch screen and can be set to read in oz / min or ml / min.



Volumetric Flow Meter

Proper calibration of the liquid system is critical to achieve a proper granular / chemical mixture. For information on pump calibration and flow meter calibration to determine liquid flow rate, see the Calibration and Operation section on page 48.

Emptying the remaining liquid may be done by using the reverse function on the control panel. This will pump liquid back into the mix tank. Then drain the remaining liquid into a suitable container. Clean water should be pumped through the calibration tube and mix tank when finished.



WARNING Always dispose of chemical or diluted chemical according to your local, state, and federal regulations.



Only you, the operator, can determine the length of time required to completely rinse all chemical residue from the tank and plumbing system.

SECTION
D**ELECTRICAL OPERATION**

HIGH VOLTAGE ~ Always disconnect the power source before working on or near the control panel or lead wires.



HIGH VOLTAGE ~ Use insulated tools when making adjustments while the controls are under power.



AUTHORIZED PERSONNEL only shall work on the control panel. Never allow anyone who has not read and familiarized themselves with the owner's manual to open or work on the control panels.

NOTICE

USC recommends the use of a surge protection device with a minimum rating of 400 Joules for all automated main control panels.

General Panel Descriptions:

- The AT500H Automated Treater Panel is an enclosure that contains the electrical components required to actuate the seed treater.
- Power for the treater is supplied here. Power to this panel is hard wired.

USC STARTUP SCREEN

This is the first screen the operator will see after the system receives power at the initial startup. After reading the User Acknowledgement statement, push the Acknowledge button at the bottom of the popup window to close the screen (see page 23, top).

While the system is booting up, the touch screen will display a timer bar at the bottom of the Start Up Screen (see page 23, middle).

Once the timer bar reaches the end it will disappear and be replaced with a line of text that reads Press Screen to Continue. Press anywhere on the screen and it will advance to the Main screen (see page 23, bottom).

AT500H TREATER
USC STARTUP SCREEN

USER ACKNOWLEDGEMENT!!!

Before starting this equipment, take time to carefully study the included documentation. Specifically, ensure that all safety requirements are understood and met.

This system initializes as an AT500 with two pump stands. These pump stands initialize with one pump head and volumetric flow meters. If this is not the exact hardware that your treating system will be operating then setup may be required.

Please contact your USC equipment dealer or a member of USC's service personnel to assist with this program's initial setup. If you have a "Startup" scheduled, the startup technician will perform the initial setup at that time.

Any software or hardware modifications to USC equipment, without prior written consent from USC, may void product warranty. Please contact USC, LLC with any questions or concerns.

IND 23 00

AT500 v1.02.00

Loading Please Wait...

INDUSTRY LEADER. INDUSTRY INNOVATOR.

2320 124th RD ~ SABETHA, KS 66534 ~ (785) 431-7900
WEBSITE: www.uscllc.com

© 2017. USC, LLC. ALL RIGHTS RESERVED.

AT500 v1.02.00

Press Screen to Continue

INDUSTRY LEADER. INDUSTRY INNOVATOR.

2320 124th RD ~ SABETHA, KS 66534 ~ (785) 431-7900
WEBSITE: www.uscllc.com

© 2017. USC, LLC. ALL RIGHTS RESERVED.

FUNCTIONS COMMON TO ALL SCREENS

At the top of every screen is the dark blue title bar. In the center of the screen is the title. In the upper left corner is the date and time. Below that is the treater message bar. It has a light green background and will display messages notifying the operator of which stage the treating process is in. In the top right corner is the program version, and current user identification.

At the bottom of every screen are the buttons that the operator uses to navigate from one screen to another. Pressing the button in the lower right hand corner with USC U-Treat logo on it returns the operator to the startup screen.

AT500H TREATER

MAIN SCREEN

This screen informs the operator of the status of all system motors and electrical devices and allows for control / adjustment of system operations.

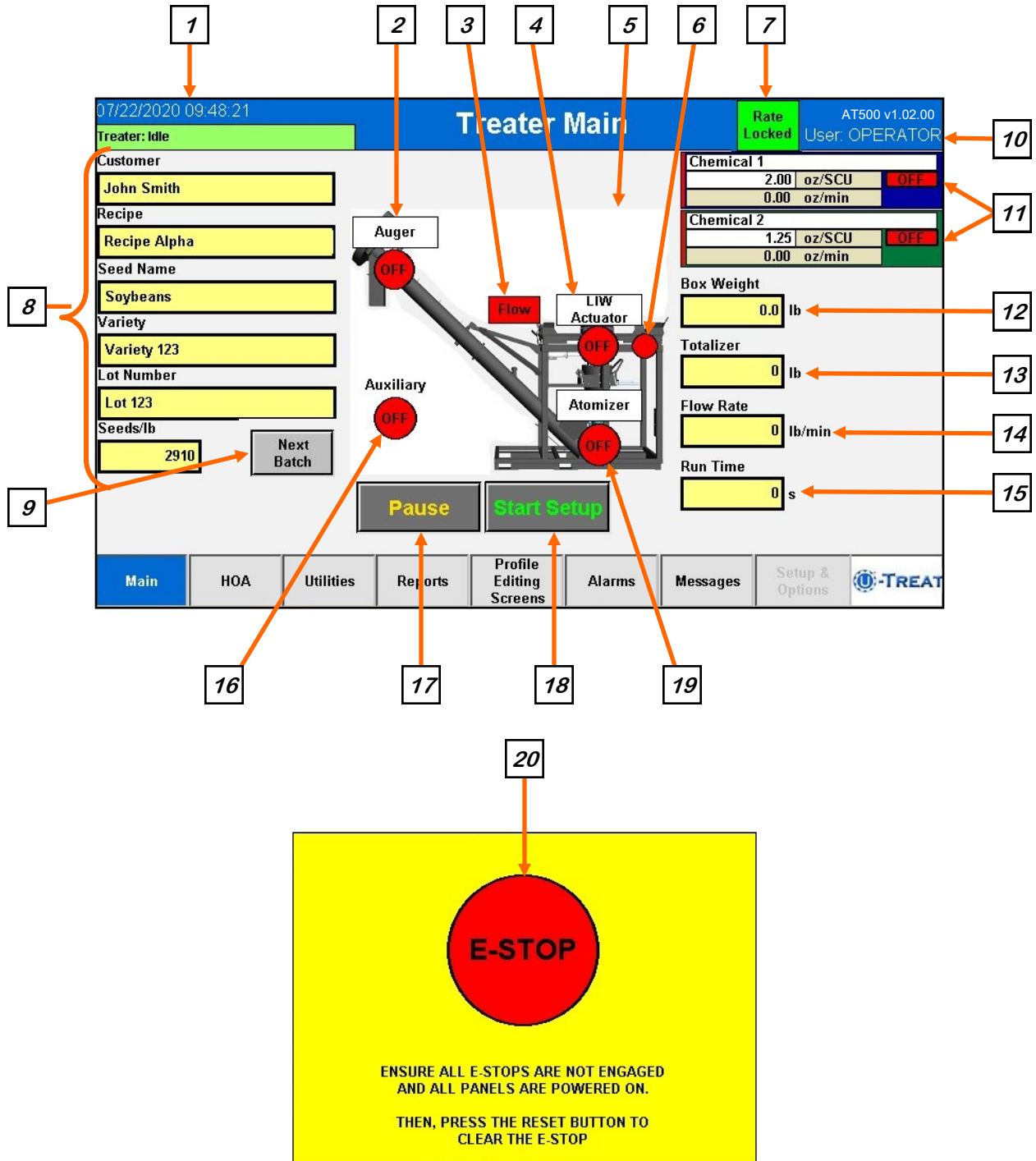

MAIN SCREEN DESCRIPTIONS

1. DATE & TIME: The date and time are displayed in the upper left corner of the screen. If you press the text, you will advance to the Date & Time screen. Select the top three boxes to set the year month and day. Select the bottom three boxes to set the time. The system is based on a 24 hour clock. When keying in the hour, 2:00 P.M. is 14 hours as in the example below. If you wish to view the time on the screens in 12 hour display, check the box below the time setting. The display in the upper left corner will now show a 12 hour clock indicating A.M. or P.M. Press the Set Date & Time button in the center of the screen to save your entries.

2. AUGER MOTOR INDICATOR: Informs the operator if the motor for the auger motor is ON or OFF.

3. FLOW DETECTION INDICATOR: Informs the operator as to when the scale has seen enough weight fluctuation to assume that the seed is either being removed or added to the scale.

4. LOSS IN WEIGHT ACTUATOR INDICATOR: Informs the operator if the actuator motor is ON or OFF. When ON, the title will change to display the gate open percentage.

5. INLET CONVEYOR MOTOR INDICATOR: The software has the ability to send an output to the customer supplied and operated inlet conveyor. If the indicator is green, the conveyor is requested to be ON. This doesn't necessarily indicate the conveyor is actually running.

6. PROXIMITY SWITCH INDICATOR: Informs the operator of the proximity switch status. If it is green it detects seed. If it is red it does not detect seed.

7. RATE LOCK INDICATOR: When this indicator is present, the Rate Lock feature is active. It is configured on the Utilities screen (see page 33).

MAIN SCREEN DESCRIPTIONS

8. CURRENT RUN PARAMETERS: These displays show the general information that was entered on the Start Setup popup screen prior to starting the run.

9. NEXT BATCH: When the system is in Batch mode, and a batch has been completed, pressing this button will start a new run using the same parameters from the last batch.

10. SECURITY SCREEN: In the upper right corner is the current user name. If you press the text, you will advance to the Security screen. The operator uses this input to obtain access to all options on this screen. When the Password button is pressed a keypad will appear on the screen. Select the up arrow on the left side to enter upper case text. The password is USC and should only be made accessible to personnel qualified to operate the system. The User Name will stay OPERATOR.

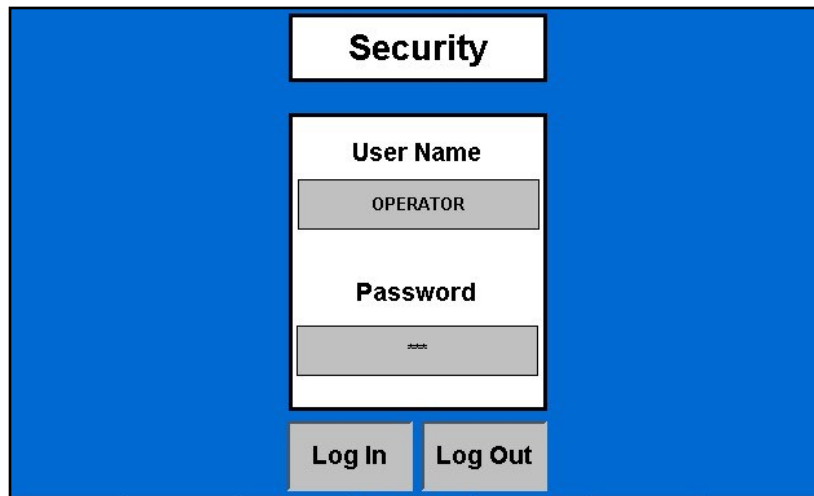

11. PUMP MODULES: This block of information informs the operator of the pump motor status (ON or OFF), currently selected chemical, target flow rate and actual flow rate from flow meter. A vertical line on the left side of the pump module will indicate the tolerance status. If it is green, the pump flow rate is within tolerance. If it is red, it is out of tolerance.

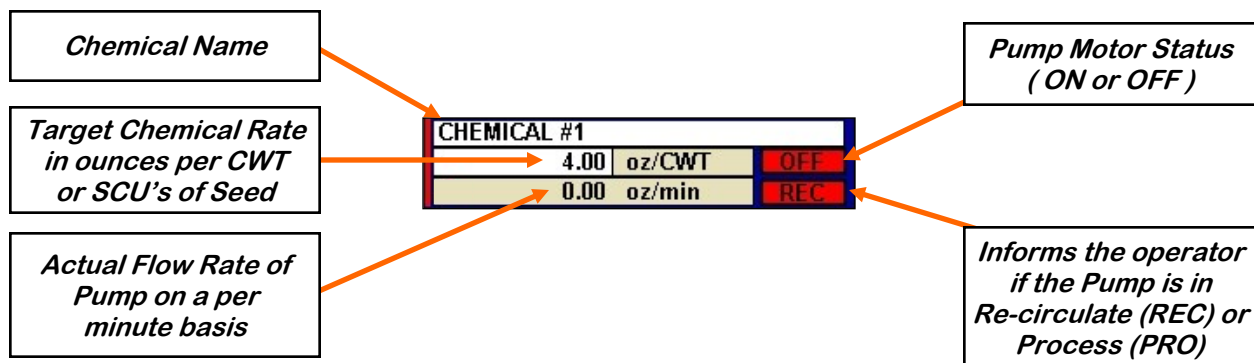

MAIN SCREEN DESCRIPTIONS

11. PUMP MODULES (Continued): If recipe mode is not active, the chemical name and target rate fields will turn from white to grey and become active buttons. Selecting either one will bring up a popup screen with both pumps listed. Select a pump name and the select chemical profile screen appears. Select the chemical you wish to change it to. Select the treating rate box next to it and a numeric keyboard allows entry of the treating rate. Use the box on the right to set the measurement type. When all the information is set, press the Save button then Exit.

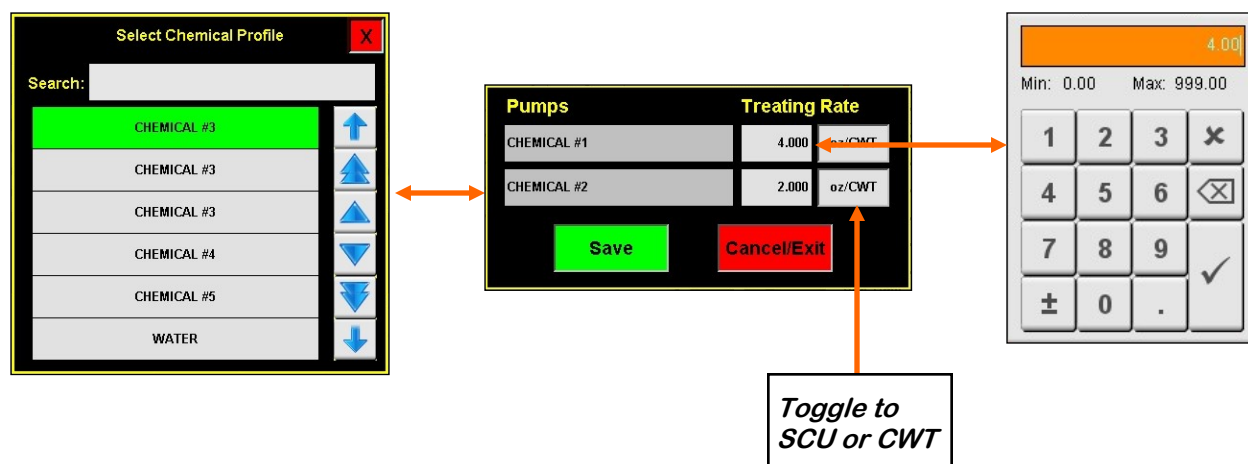

12. BOX WEIGHT: This display informs the operator the weight of the product on the scale in real time. For this weight to show only the product, the scale will be zeroed out with an empty box on the scale. This will be done during installation and setup.

13. TOTALIZER: This display indicates the amount of seed the program estimates has been treated on the last run.

14. FLOW RATE: This display indicates the amount of product being treated per minute in real time. It will display the final number after the run is complete.

15. RUN TIME: This is the amount of time that seed has been flowing through the system during a run. The time is displayed in seconds.

16. AUXILIARY MOTOR INDICATOR: Informs the operator if the motor for the auxiliary device attached to the system is ON or OFF.

MAIN SCREEN DESCRIPTIONS

17. PAUSE: Once the Start button has been pushed and the system begins to operate, the Pause button appears. Pressing it will stop the run in progress. If the system was automatically paused by the system due to an alarm situation, correct the error then press the reset button on the control panel. The operator may now press the Continue button to resume the run. If they press the Terminate button, any seed that has not been emptied from the hopper or seed wheel will not be added to the current report.



18. START SETUP: This is used to start the machine after all motors have been placed into the Auto position. Press the button and a pop-up window appears. You may select the chemical recipe and seed type by selecting one of the box's in the popup or search the listing for an existing entry by typing the name in the search field or using the navigation arrows. The other boxes will automatically populate with the information from the seed profile selected. When all the information has been added press Start to begin the run. Once the system begins to operate it becomes the Shutdown button.

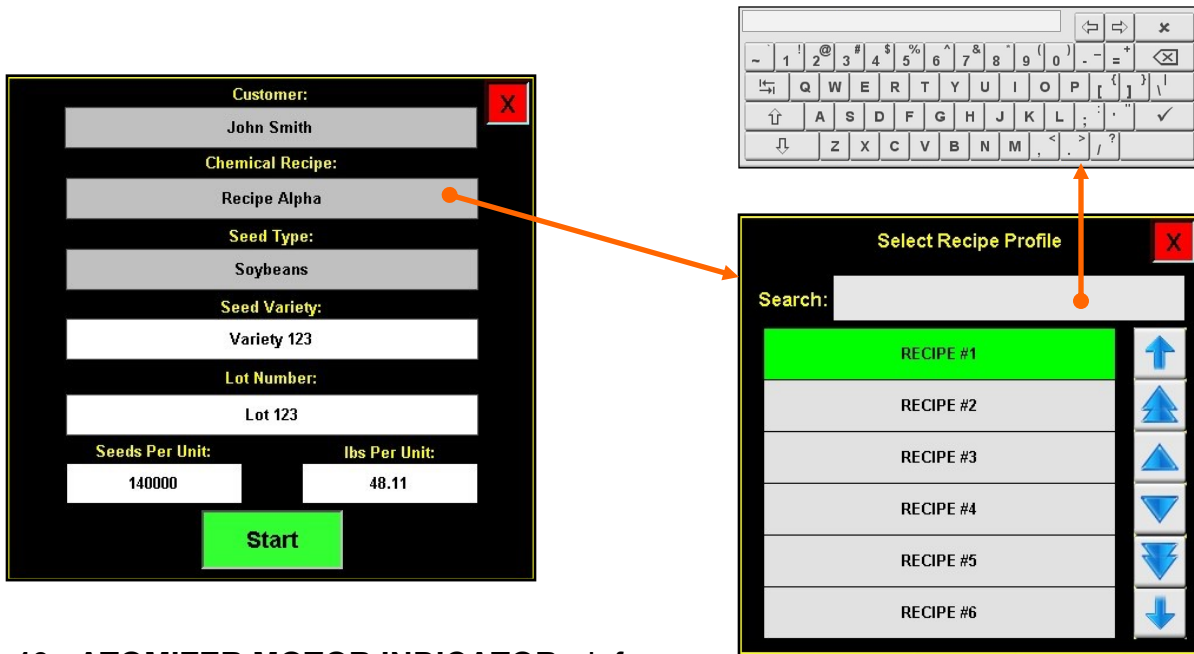

19. ATOMIZER MOTOR INDICATOR: Informs the operator if the atomizer motor is ON or OFF.

20. EMERGENCY STOP: This blinking display is activated when the system's E-Stop button is activated.

H-O-A (HAND-OFF-AUTO) SCREEN



These H-O-A buttons force the selected component to be energized (HAND), de-energized (OFF), or automatically energized by the normal logic sequence (AUTO). The HAND function will cause the component to operate independent of whatever else the system is trying to do automatically. These functions should not normally be used if the automated sequencing is active. **Be sure to understand the impact of energizing or de-energizing a component with the settings before using them. These commands are not a substitute for Lockout/Tagout procedures when working on or near this machine. Use proper lockout/tagout procedures to disable the equipment before servicing it.**

Hand-Off-Auto controls are provided for most of the automated devices in the system, and are accessed on this screen. All treater, conveyor and pump stand motors are controlled here.

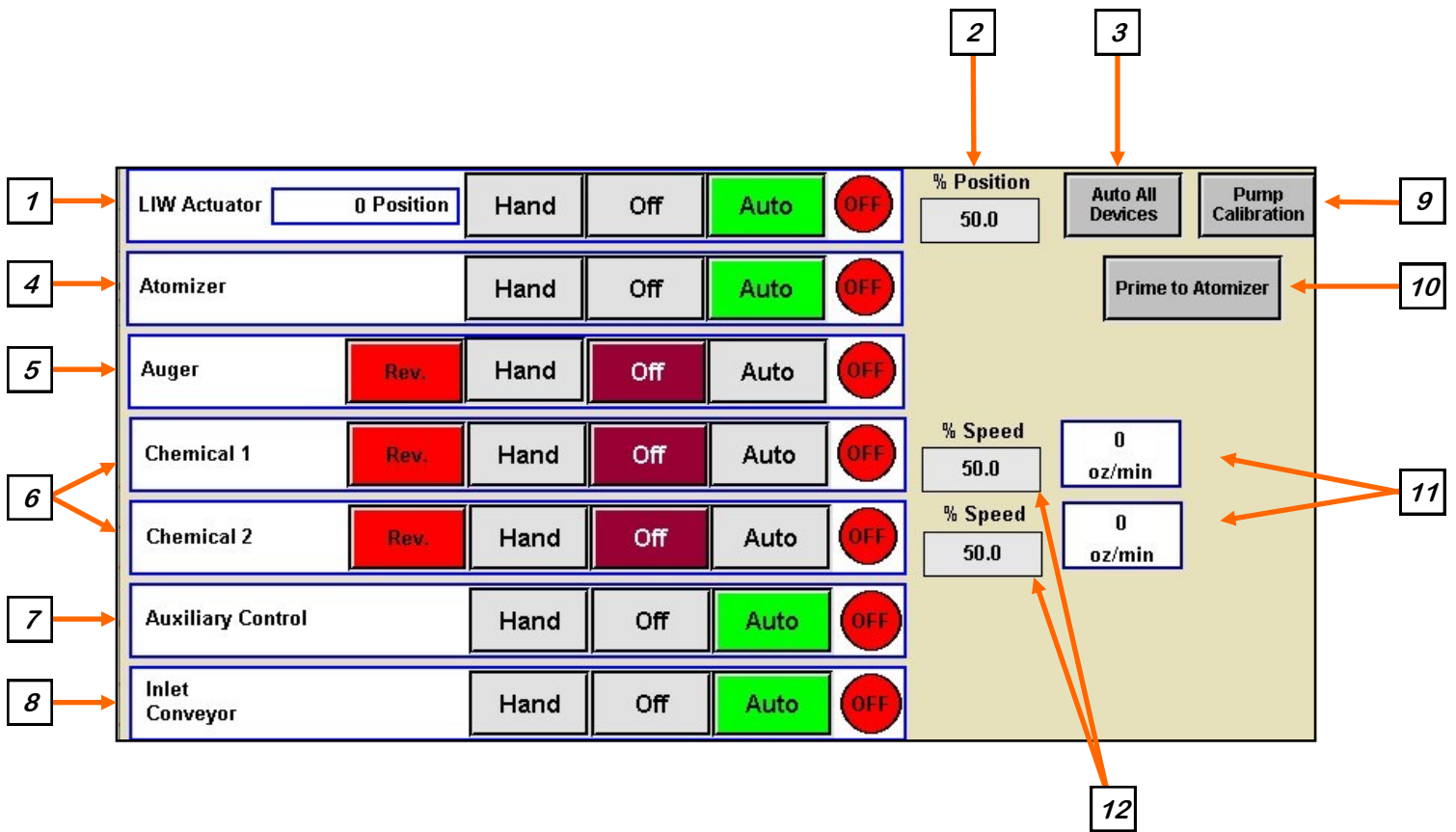

H-O-A (HAND-OFF-AUTO) SCREEN

1. LIW ACTUATOR CONTROL MODULE: This module controls the function of the loss in weight actuator gate. The Hand button will open the gate to the selected percentage of maximum open position. The Off button will turn the device off and reset the gate to the minimum gate position. The Auto button will place the device in the automatic mode of operation. The actuator will not operate in this function unless all other needed devices are in the Auto mode and the Start button is pressed on the main screen.

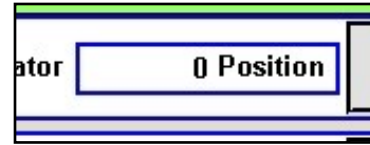

2. LIW ACTUATOR PERCENT POSITION: When this button is pressed, a numeric touch pad (right) will appear to allow the operator to manually adjust the percentage of the actuator gate. When running in the Auto mode the program will override this manual setting.



3. AUTO ALL DEVICES: When this button is pushed, it globally changes all treater HOA settings to the Auto mode of operation.

4. ATOMIZER CONTROL MODULE: This module controls the function of the atomizer. The Hand button will place the atomizer in the manual mode of operation. The Off button will turn the associated device in the Off mode of operation. The Auto button will place the device in the automatic mode of operation. The motor will not operate in this function unless all other needed devices are in the Auto mode and either the Prime to Atomizer or the Start button is pressed on the main screen.

5. AUGER CONTROL MODULE: This module controls the function of the auger. The Hand button will place the auger in the manual mode of operation. The Off button will turn the associated device in the Off mode of operation. When OFF the REV. button appears. This allows the operator to reverse the Auger for cleanout. (This is only visible if an Reversing Auger is used.) The Auto button will place the device in the automatic mode of operation. The motor will not operate in this function unless all other needed devices are in the Auto mode and the Start button is pressed on the main screen.

6. PUMP CONTROL MODULES: These modules control the function of the Pump Stands. The Hand button will place the desired pump in the manual mode of operation. The Off button will turn the associated device in the Off mode of operation. When OFF the REV. button appears. This allows the operator to reverse the pump direction and pump the product back into the mix tank. The Auto button will place the device in the automatic mode of operation. The pump will not operate in this function until the Start button is pressed on the main screen.

H-O-A (HAND-OFF-AUTO) SCREEN

7. AUXILIARY CONTROL: These modules allow the operator to control any unit which is plugged into the auxiliary port located on the bottom of the treater control panel (see page 15). The Hand button will allow the user to operate the unit in the manual mode of operation. The Off button will disconnect control to the auxiliary port. The Auto button will place the unit in the automatic mode of operation. Any unit plugged into the auxiliary port will not operate in this function until the Start button is pressed on the main screen. It will also turn off using the same logic as the pump stands.

8. INLET CONVEYOR CONTROL MODULE: This module does not control the inlet conveyor. It sends a signal to the control panel that does informing it when it needs to be turned On or Off. The Hand button will request it to turn on in the manual mode of operation. The Off button will request it to place the associated device in the Off mode of operation. The Auto button will place the program in the automatic mode of operation. The request to turn the conveyor motor On will not be sent unless all other needed devices are in the Auto mode and the Start button is pressed on the main screen. The indicator displays what the program is requesting. It does not necessarily mean that the conveyor is actually running or not.

9. PUMP CALIBRATION: Pressing this button brings up the pump calibration screen below. This screen is used to calibrate the pumps. Enter the number of the pump you wish to calibrate and a target run time for the calibration. The longer the run time the more accurate the calibration. USC recommends a minimum of 60 seconds. Pressing the Jog Pump Motor button will turn the pumps on and off to fill the process lines attached to the top of the calibration tube. Press the button again to stop the flow. Continue until liquid in the calibration tube valve. Place a measuring receptacle under the tube coming from the valve. Press the START button to begin the calibration. When the target run time has elapsed, the pump will shutoff automatically. If for any reason you need to stop the process, press the STOP button. If the calibration is stopped before the target time has elapsed, the operator must start the process over again. If you press start and continue from your stopping point, the calibration will not be accurate. Enter the receptacle reading in the Cal. Tube Total. Press the Update Ratio button to correct the ratio. Closing this popup will stop the calibration process if it has not been completed.

H-O-A (HAND-OFF-AUTO) SCREEN

Help	Pump# to Adjust: 1	Chemical Name: Chemical 1	X
Target Run Time (seconds):	30	Actual Rate (oz/min):	0.0
Target Rate (oz/min):	33.3	Jog Pump Motor	
Rough Est. Total (Fl. oz):	16.63	START	STOP
Totals		Calibration Ratio	
Cal. Tube Total (Fl. oz):	1.00	Current Ratio:	1.00
Pump Totalizer (Fl. oz):	1.00	Calculated Ratio:	1.00
Elapsed Run Time (seconds):	0.0	UPDATE RATIO	
Processing Calibration			

10. PRIME TO ATOMIZER: Used before a controlled startup to preload chemical in the tubing leading to the atomizer. To operate this button, place the atomizer and any pump that will be used in the Auto mode. Next press and hold the Prime to Atomizer button. The atomizer and pumps will turn on and the liquid will be directed to the atomizer. The atomizer and pumps will run as long as the button is being pressed. When the button is released the atomizer and pumps will shut-off.

11. FLOW RATE INDICATOR: When the pump is in operation, this displays the liquid flow rate in real time.

12. PUMP PERCENT SPEED: When this button is pressed, a numeric touch pad will appear to allow the operator to manually adjust the speed of the pumps. When running in the Auto mode the program will override this setting.

AT500H TREATER
UTILITIES SCREEN

This screen allows the operator to set various system parameters.

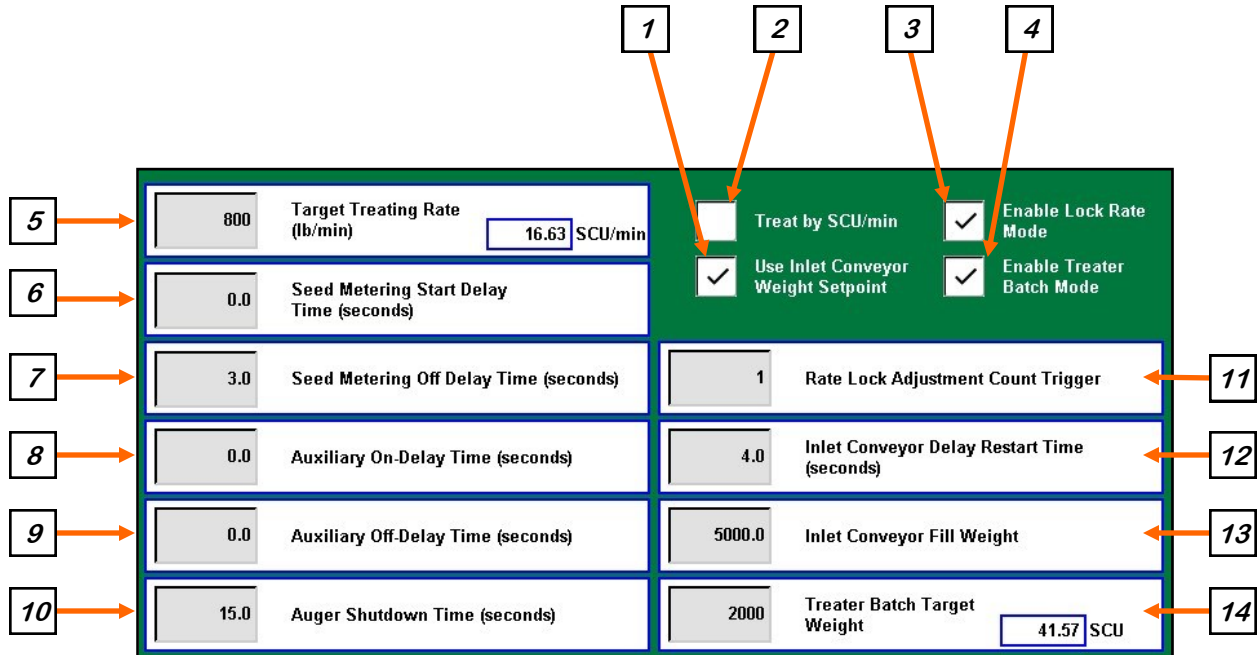

NOTICE

When buttons 5 - 14 are pressed, a numeric touch pad (right) will appear allowing the operator to enter in a number for that particular parameter.

1. USE INLET CONVEYOR WEIGHT SETPOINT: Checking this box will allow the inlet conveyor to fill to a specified weight before pausing the conveyor. That weight is defined by the value entered in the Inlet Conveyor Fill Weight . See item 13 on page 35.

2. TREAT BY SCU / MIN: When this box is checked, the primary Target Treating Rate will be calculated in Seed Count Units per minute. The Flow Rate display on the main screen will also change to SCU/min. Unchecked, it will be calculated in pounds per minute.

3. ENABLE LOCK RATE MODE: Checking this box allows the system to lock in the requested treating rate after a specified number of moves. The number is defined by the value entered in the Rate Lock adjustment Count Trigger. See item 11 on page 34.

UTILITIES SCREEN

4. ENABLE TREATER BATCH MODE: This function can be used if you wish to treat less than a full box. This box must be checked to make the Treater Batch Target Weight present. This allows the operator to define how much of the seed in the box to treat. This may also be used when seed is entering the system from a customer supplied and controlled conveyor. When this box is checked, the operator may enter a target weight for a run. When the treater reaches the desired weight, the weighing device will stop and a Next Batch button will appear on the treater screen. The operator will watch until all of the seed has discharged from the auger. They may then replace the treated box with an empty one and press the Next Batch button to continue treating.

5. TARGET TREATING RATE: Pressing this button allows the operator to adjust the estimated treating rate in pounds or SCU's per minute. This number is used by the system to control the rate of the seed gate and pumps.

6. SEED METERING START DELAY TIME (seconds): The start delay time is the number of seconds from the time the atomizer and auger have been started and the proximity switch detects seed until the actuator opens the slide gate to begin treating.

7. SEED METERING OFF DELAY TIME (seconds): The off delay time is the number of seconds from the time the shutdown button is pressed for the actuator to close the slide gate atomizer to stop.

8. AUXILIARY ON DELAY TIME (Seconds): Pressing this button allows the operator to adjust the on delay from the time the proximity switch in the hopper above the seed gate detects seed to the time a signal is sent to an auxiliary device connected to the system to start.

9. AUXILIARY OFF DELAY TIME (Seconds): Pressing this button allows the operator to adjust the off delay from the time the proximity switch in the hopper above the seed gate no longer detects seed to the time a signal is sent to an auxiliary device connected to the system to stop.

10. AUGER SHUTDOWN TIME (seconds): This delay is to add run time for the auger to ensure that after the treater has shut down and all of the seed for the run has been discharged from the auger.

11. RATE LOCK ADJUSTMENT COUNT TRIGGER: The number entered here will be the number of times the actuator will move to adjust the flow rate before locking it in position. This value will only be used when the enable rate lock option is checked on the Utilities screen.

UTILITIES SCREEN

12. INLET CONVEYOR DELAY RESTART TIME (seconds): Pressing this button allows the operator to adjust the restart time of the customer supplied and operated inlet conveyor and proximity switch after it no longer detects seed. The other condition requiring the delay would be when the Use Inlet Conveyor Weight Setpoint is enabled and the fill weight has been met.

13. INLET CONVEYOR FILL WEIGHT: Pressing this button allows the operator to define the scale weight that will pause the customer supplied and operated inlet conveyor.

14. TREATER BATCH TARGET WEIGHT: When operating in batch mode, the operator will enter the weight for each individual batch.

AT500H TREATER

REPORTS

After the run is complete and all of the seed has been run through the auger, press the shutdown button. Once a run is finished the data is saved automatically in the reports file. The operator may access these records from the Reports screen. Press the Reports button and you will be viewing the last recorded run. The three columns at the top of the screen display all of the information recorded from the run. In the middle is a grey box. Select it and a keyboard will popup so you may enter notes about this run. At the bottom, the values for both pumps are shown.

Selecting the grey arrow in the upper left corner activates the dropdown list displaying all of the reports. Use the arrows to scroll through them or press the grey box to enter the name of a specific report. That report will be brought to the top of the list. The system is capable of storing up to 5000 entries.

Record Type: Treater **Seed Profile:** Soybeans **Totalizer Weight:** 932
Start Time: 2020/07/22, 09:49:00 **Variety:** Variety 123 **Totalizer SCU:** 19.37
End Time: 2020/07/22, 09:51:50 **Lot Number:** Lot 123 **Avg. Weight/min:** 771
System Paused: False **Seeds/Unit:** 140000 **Avg SCU/min:** 16.03
Measurement Mode: Standard **Seeds/Weight:** 2910 **Seed Run Timer (sec):** 72.5
Recipe: Recipe Alpha **Weight/SCU:** 48.1
Auxiliary Used: True **Calibration Ratio:** 1.04 **Notes:**

Chemical Name	Total oz.	% Acc.
Pump #1: Chemical 1	38.0	98.2
Pump #2: Chemical 2	23.8	98.2

Save

Search:

2020/07/17, 10:23:25 Treater	↑
2020/07/22, 09:51:50 Treater	↑↑
2020/07/22, 09:54:11 Treater	↑↑↑
<blank>	↓↓↓
<blank>	↓↓↓
<blank>	↓↓↓

Selection: 2 Viewing: 1 - 10 of 5000 **Jump to Record #:** Total Used Records: 3

Totalizer Weight: 932
Totalizer SCU: 19.37
Avg. Weight/min: 771
Avg SCU/min: 16.03
Seed Run Timer (sec): 72.5

Notes:

Save

PROFILE EDITING SCREENS

Selecting the Profile Editing Screens button at the bottom of the screen will bring up a popup screen with four active buttons. This is where the system parameters are manually entered for Seed, Chemical, Recipe profiles and access to the Import / Export screen. The operator must be logged in as a level 1 OPERATOR to edit these profiles. Only individuals with administrative login privileges may have access to the Pump Stand Editing profiles. See pages 38 through 45 for detailed information for entering the data.

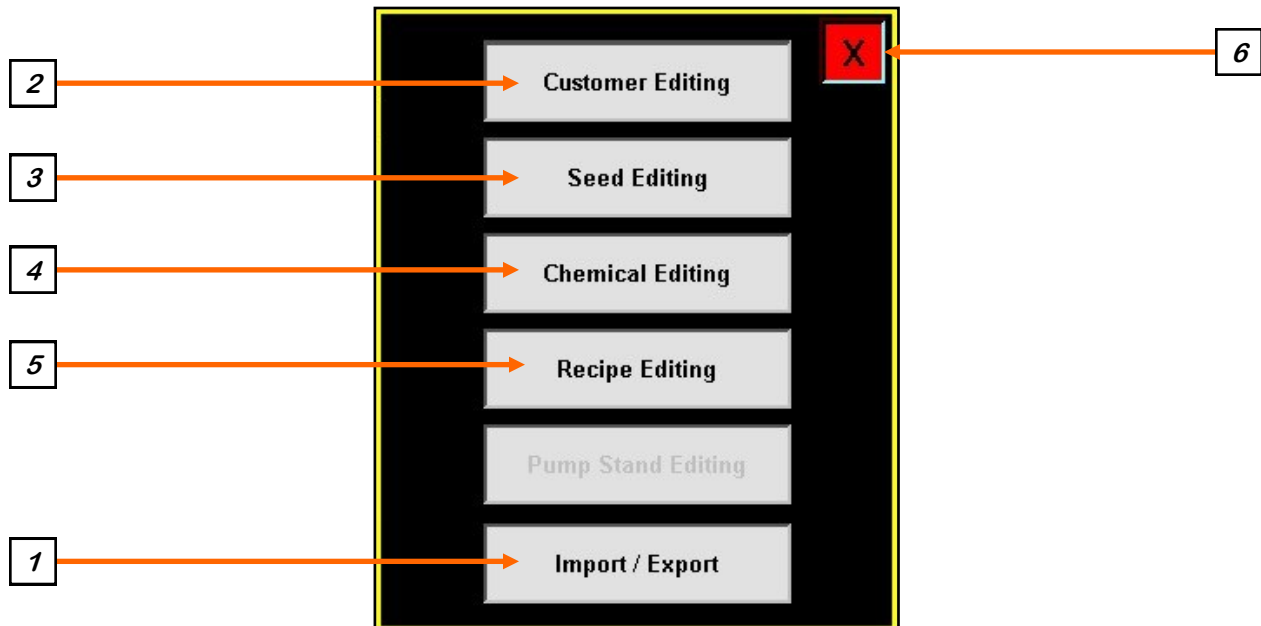

PROFILE EDITING SCREENS

1. IMPORT / EXPORT LISTS: Pressing this button will advance to the Import / Export screen. From here you may choose from a variety of profiles and recipes that may be either imported from a flash drive or exported to a flash drive. The USB port is located on the bottom of the main control panel. Job Reports may be exported but not imported. After they are exported you may delete them from the system.

After pushing the Export button, the message above it will be **Copying to USB...**, then it will change to indicate the number of files it is in the process of exporting. There will also be a warning above the module, **Please do not “Exit” or cycle power.** Exiting or shutting off the power will stop the process before it is complete. None of the buttons will function if you have not inserted a flash drive into the USB port.

Pressing the Delete DRM button will delete all system data. This data does not include any of the items listed in the table below. When the Delete DRM button is pressed the system will delete every DRM file. **Once that is complete the system will Restart Automatically!**

The screenshot shows the 'Import & Export' interface. At the top, it displays the date '03/07/2018 16:44:24', the title 'Import & Export', and the version 'AT500 v1.02.00'. Below this, it shows 'Treater: Idle' and 'User: OPERATOR'. A 'Delete DRM' button is visible. The main area contains a table with columns for 'List', 'Total Records', 'Status', and 'Actions'. The table lists various system components like Alarm Log, Messages Log, Events Log, Job Reports, Seed Profiles, Chemical Profiles, Chemical Recipes, Pump Profiles, Seed Path Profiles, and Conveyor Profiles, each with its respective record count and available actions (Export, Import, Delete).

List	Total Records	Status	Actions
Alarm Log	0		Export Delete
Messages Log	19		Export Delete
Events Log	63		Export Delete
Job Reports	163		Export Delete
Seed Profiles	6		Export Import Delete
Chemical Profiles	6		Export Import Delete
Chemical Recipes	6		Export Import Delete
Pump Profiles	2		Export Import Delete
Seed Path Profiles	25		Export Import Delete
Conveyor Profiles	2		Export Import Delete

At the bottom, there is a navigation bar with buttons for 'Main', 'HOA', 'Utilities', 'Reports', 'Profile Editing Screens', 'Alarms', 'Messages', 'Setup & Options', and the 'U-TREAT' logo.

PROFILE EDITING SCREENS

2. CUSTOMER EDITING: Pressing this button will advance to the Customer Editing screen. If you are looking for a specific customer, select the grey arrow in the upper left corner to open the customer profile list. You may enter the name in the Search box at the top of the seed list or use the arrows to scroll through the list. To create a new customer profile, select a used or unused profile from the list, select the name box and key in a new name and all of the details of the customer, then press the Save button.

If the new customer is similar to an existing one, select the existing customer and press the Copy button. If you select an existing customer and press the Paste button, all of the characteristics will be copied except the name. If you select a blank entry and press the Paste button, all of the characteristics will be copied but the name will be blank. Enter a new name and press the save button.

The screenshot shows a customer editing interface. On the left, there are two vertical buttons labeled 'Copy' and 'Paste'. The main area contains four input fields: 'Name: John Smith', 'Address 1: 123 4th St', 'Address 2: Sabetha , KS 66534', and 'Phone: 123.456.7890'. At the bottom right, there are two buttons: a green 'Save' button and a red 'Clear' button.

The screenshot shows a search and list interface. At the top left is a 'Search:' box with a grey arrow button to its right. Below this is a list of customer names: 'John Smith', followed by five '<blank>' entries. To the right of each name is a blue arrow button pointing up or down. At the bottom left, there is a status bar with the text: 'Selection: 1', 'Viewing: 1 - 6 of 500', and 'Total Used Records: 1'. At the bottom right, there are two buttons: a green 'Save' button and a red 'Clear' button.

PROFILE EDITING SCREENS

3. SEED EDITING: Pressing this button will advance to the Seed Editing screen. If you are looking for a specific seed, select the grey arrow in the upper left corner to open the seed profile list (see page 40, top). You may enter the name in the Search box at the top of the seed list or use the arrows to scroll through the list. To create a new seed profile, select a used or unused profile from the list, select the name box and key in a new name and all of the characteristics of the seed, then press the Save button.

If the new seed is similar to an existing one, select the existing seed and press the Copy button. If you select an existing seed and press the Paste button, all of the characteristics will be copied but the name will be unchanged. If you select a blank entry and press the Paste button, all of the characteristics will be copied but the name will be blank. Enter a new name and press the save button.



PROFILE EDITING SCREENS

3. SEED EDITING (Continued):

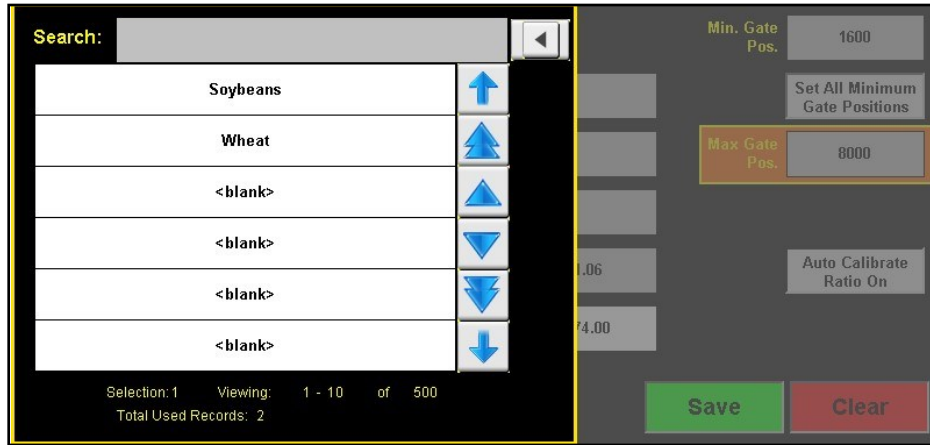

1A. MINIMUM GATE POSITION: Pressing this button brings up a keypad to enter a value for a minimum gate position for this individual seed profile.

1B. SET ALL MINIMUM GATE POSITIONS: Pressing this button brings up a popup screen. Press the gray box on the right and use the key to enter a value for all minimum gate positions. After entering the value press the OK button. The timer bar appears showing the progress of the actuator. When the actuator stops, press the red X at the top to return to the seed editing page.

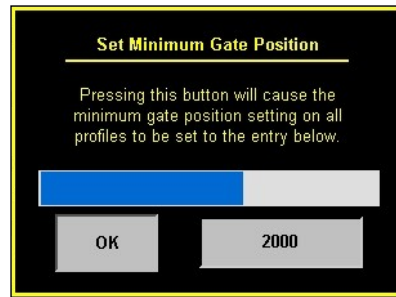
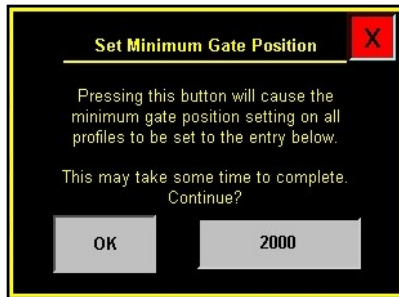

1C. MAXIMUM GATE POSITION: The default setting for the maximum gate position is 8000. It is preset because opening the gate any wider begins to overload the auger. If you wish to reduce the maximum open position reduce this number.

1D. AUTO CALIBRATE RATIO: Press this button to toggle the Auto Calibrate Ratio function from On to Off. The Calibration Ratio is the calibration of the seed profile and the speed indicator that displays the last flow rate at which a calibration occurred. The button is directly to the right of the Cal. Ratio button. After each calibration, the Cal. Ratio button will display the automatically calculated ratio. It may also be pressed to manual enter a value.

PROFILE EDITING SCREENS

4. CHEMICAL EDITING: Pressing this button will advance to the Chemical Editing screen where the operator may define the parameters for each individual chemical. If you are looking for a specific profile you may select the grey arrow in the upper left corner to access the seed profile list (see page 42, top). You may enter the name in the Search box at the top of the seed list or use the arrows to scroll through the list. To create a new chemical profile, select a used or unused box from the list, select the name box and key in a new name and all of the characteristics of the chemical, then press the Save button. After you press save, a popup will appear warning you to wait until it saves the changes before you leave the screen (see page 42, bottom).

If the new chemical is similar to an existing one, select the existing chemical and press the Copy button. If you select an existing chemical and press the Paste button, all of the characteristics will be copied but the name will be unchanged. If you select a blank entry and press the Paste button, all of the characteristics will be copied but the name will be blank. Enter a new name and press the Save button.

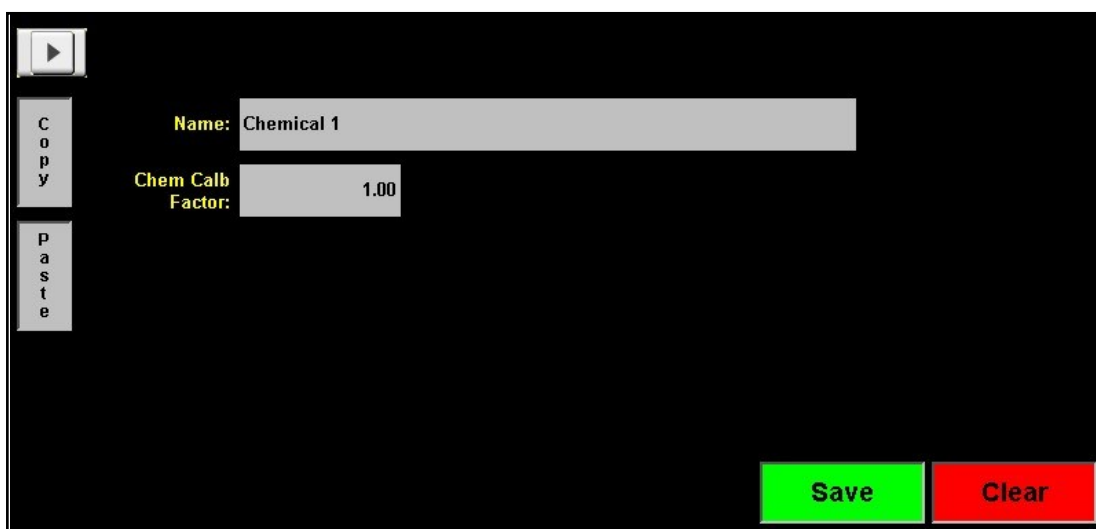

The screenshot displays the Chemical Editing interface. On the left side, there is a vertical toolbar with three buttons: a grey arrow button at the top, a 'Copy' button in the middle, and a 'Paste' button at the bottom. The main area contains a form with the following fields:

- Name:** A text input field containing 'Chemical 1'.
- Chem Calb Factor:** A text input field containing '1.00'.

At the bottom right of the screen, there are two buttons: a green 'Save' button and a red 'Clear' button.

AT500H TREATER
PROFILE EDITING SCREENS

4. CHEMICAL EDITING (Continued):

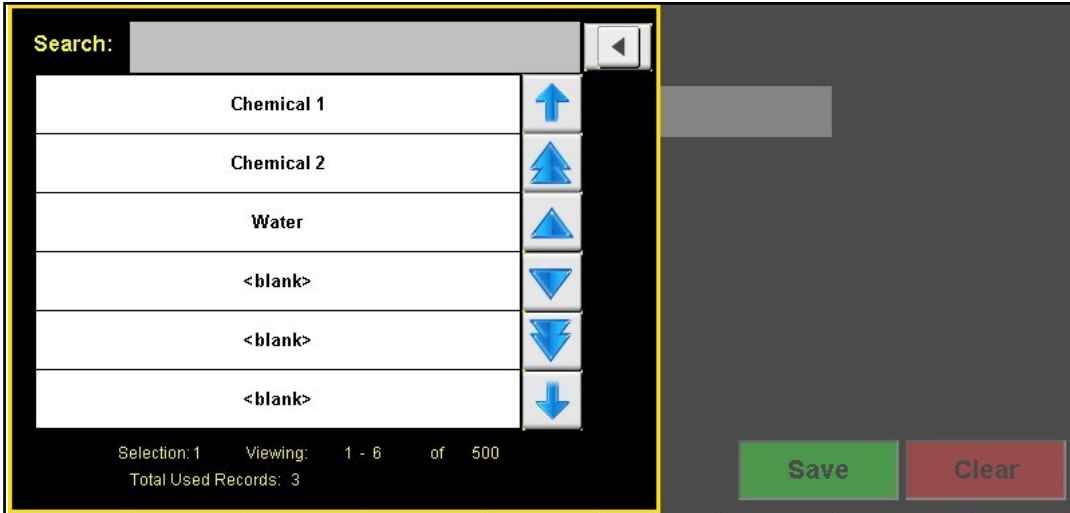

PROFILE EDITING SCREENS

5. RECIPE EDITING: Pressing this button will advance to the Recipe Editing screen where the operator defines the parameters for each Recipe. If you are looking for a specific profile you may select the grey arrow in the upper left corner to access the seed profile list (see page 45, bottom). You may enter the in the Search box at the top of the seed list or use the arrows to scroll through the list. To create a new recipe profile, select a used or unused box from the list, select the name box and key in a new name and all of the characteristics of the recipe, then press the Save button

If the new recipe is similar to an existing one, select the existing recipe and press the Copy button. If you select an existing recipe and press the Paste button, all of the characteristics will be copied but the name will be unchanged. If you select a blank entry and press the Paste button, all of the characteristics will be copied but the name will be blank. Enter a new name and press the save button..

Choose which pumps will be active and the chemical for each pump. When the chemical box for each pump is selected, a drop down list will appear with all the chemicals already entered in the system. Choose a chemical from the list or scan in a barcode to select the chemical. If the bar code scanned in does not find a match, a popup will appear that reads No Match Found. This indicates that it does not already exist in the system. It will need to be entered for the first time from the Chemical Editing screen. After assigning a chemical the operator must define the treating rate. Pressing the first box to the right of the chemical brings up a numeric keyboard to enter the number of ounces or milliliters. The button to the right of that toggles back and forth between Cut weight and Seed Count Units. The last button toggles between Off and Auto.

The Enable Recipe Control button near the top of the center of the screen allows the operator to turn the recipe option On or Off. Press the Save button to file any changes made to the screen. When the Enable Recipe Controls button is in the On position, the operator will be able to select a recipe from the Start Setup screen before beginning a run. It may be selected but not modified from the Start Setup screen. All changes must be made from the Recipe Editing screen.

AT500H TREATER
PROFILE EDITING SCREENS

5. RECIPE EDITING (Continued):

Enable Recipe Controls: **ON**

C
o
p
y

Name: Recipe Alpha

P
a
s
t
e

Aux Control: **ON**

	Pumps	Treating Rate		
Pump 1	Chemical 1	2.000	oz/SCU	AUTO
Pump 2	Chemical 2	1.250	oz/SCU	AUTO

Save **Clear**

Search:

Recipe Alpha	↑
<blank>	↑↑
<blank>	↑↑↑
<blank>	↓↓
<blank>	↓↓↓
<blank>	↓↓↓

g Rate

oz/SCU **AUTO**

oz/SCU **AUTO**

Selection: 1 Viewing: 1 - 6 of 500
Total Used Records: 1

Save **Clear**

AT500H TREATER
ALARMS SCREEN

The Alarms screen shows a listing of system alarms both current and reset. It also allows you to silence an active alarm and clear non active entries.

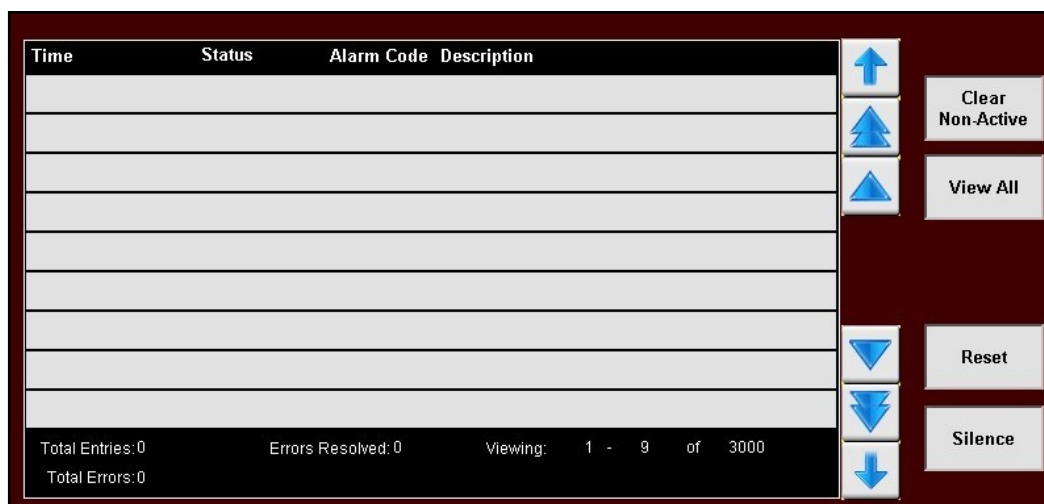

1. CLEAR NON-ACTIVE: The alarm status will change to Acknowledged once an alarm condition has been resolved and the Reset button has cleared the alarm. Pressing this button will clear all alarms with the status of acknowledged.

2. VIEW ALL: This button toggles between View All to display all alarms and faults stored at any given time (the button will be red). When an alarm or fault occurs, it will be shown in the list with a red background until the Silence button is pressed, then it will turn yellow.

3. RESET: After you think you have resolved the issue that caused the alarm, pressing this button will clear the alarm as confirmation. If you did not correct the problem it will alarm again.

4. SILENCE: Pressing this button will shut off the alarm siren and change the background of the active alarm or fault to yellow while the operator is resolving the issue.

CALIBRATION & OPERATION SECTION E

SEED FLOW CALIBRATION

1. Press the Utilities button. Ensure that the Treat by SCU / min is **NOT** checked. Enter in the Target Treating Rate in pounds per minute.

<input style="width: 90%;" type="text" value="800"/>	Target Treating Rate (lb/min)	<input style="width: 90%;" type="text" value="16.63"/>	SCU/min
<input style="width: 90%;" type="text" value="0.0"/>	Seed Metering Start Delay Time (seconds)	<input type="checkbox"/>	Treat by SCU/min
<input style="width: 90%;" type="text" value="3.0"/>	Seed Metering Off Delay Time (seconds)	<input checked="" type="checkbox"/>	Use Inlet Conveyor Weight Setpoint
<input style="width: 90%;" type="text" value="0.0"/>	Auxiliary On-Delay Time (seconds)	<input checked="" type="checkbox"/>	Enable Lock Rate Mode
<input style="width: 90%;" type="text" value="0.0"/>	Auxiliary Off-Delay Time (seconds)	<input checked="" type="checkbox"/>	Enable Treater Batch Mode
<input style="width: 90%;" type="text" value="15.0"/>	Auger Shutdown Time (seconds)	<input style="width: 90%;" type="text" value="1"/>	Rate Lock Adjustment Count Trigger
		<input style="width: 90%;" type="text" value="4.0"/>	Inlet Conveyor Delay Restart Time (seconds)
		<input style="width: 90%;" type="text" value="5000.0"/>	Inlet Conveyor Fill Weight
		<input style="width: 90%;" type="text" value="2000"/>	Treater Batch Target Weight
			<input style="width: 90%;" type="text" value="41.57"/> SCU

2. Press the Profile Editing Screens button and then push the Seed Editing button on the popup screen. Press the grey arrow to bring up the seed list and select the seed profile you wish to calibrate. The seed profile may be edited and the seed actuator gate may be calibrated for that seed. The operator must press Save button before leaving the profile or the changes will be lost and go back to what that profile was previously set to.
3. Setting Minimum Gate Position is adjustable for every profile or may be set the same for every profile. If you have varying seed sizes is it suggested to set them for each profile. This setting indicates the lowest setting that seed will flow at. To set it for a certain seed you will need to have seed available in the buffer zone above the actuator gate. With the gate completely closed, go to the H-O-A screen and set the LIW Actuator % Position setting to 5 % and place the actuator in Hand mode. Then open the gate in small increments until a small but steady stream of seed is flowing out of the actuator. Note the Gate Position reading and place the actuator back in Auto mode of operation.

SEED FLOW CALIBRATION

3. (Continued):

Pressing the Setting The Min. Gate Pos. button is used to set the value for this seed profile only. Press the button and use the keypad to enter the gate value. Pressing the Set All Maximum Gate Positions is used to set the value for all seed profiles. Press the button and a popup will appear gray box and use the keyboard to enter a value for all minimum gate positions. After entering the value press the OK button. The timer bar appears showing the progress of the actuator. When the load bar stops, press the red X at the top to return to the seed editing page.

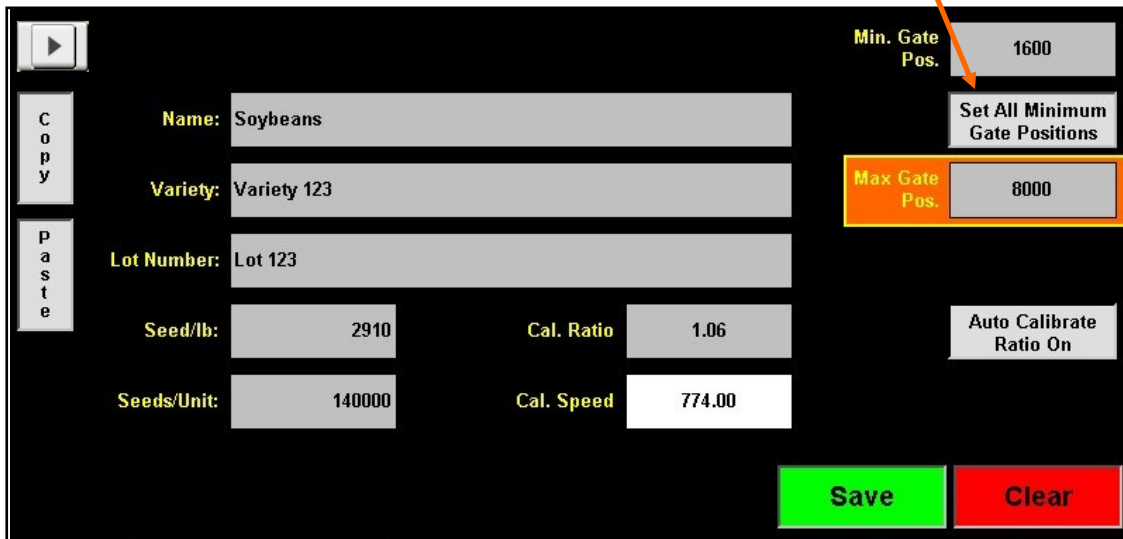
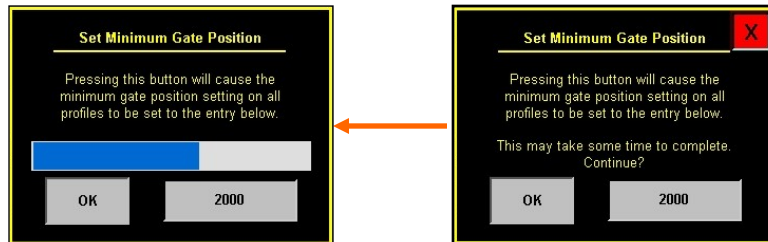

NOTICE

The maximum gate position is a global setting and will be the same for all seed profiles. The default setting is 8000. If it is set higher than 8000 it will begin to overfeed the augers maximum capacity.

FLOW METER CALIBRATION

Due to the composition of some types of chemicals, additional flow meter calibration may be required. It is recommended that, like other calibration devices, the flow meter is checked regularly and calibrated when needed. When calibrating the flow meter, each chemical must be checked and adjusted for.

1. To begin the calibration process, fill the appropriate tank with the slurry that is going to be used for this calibration.
2. Place the bottom valve in the RECIRCULATE position. Turn the corresponding pump to the Hand position and adjust the flow rate until it reads about 20 percent on the pump control module. Let the system run in recirculation mode for approximately 5 minutes. This will remove any air from the system. Now place the pump in Auto mode.

LIW Actuator	0 Position	Hand	Off	Auto	OFF	% Position	50.0	Auto All Devices	Pump Calibration
Atomizer		Hand	Off	Auto	OFF			Prime to Atomizer	
Auger		Hand	Off	Auto	OFF				
Chemical 1		Hand	Off	Auto	ON	% Speed	32		
						50.0	oz/min		
Chemical 2	Rev.	Hand	Off	Auto	OFF	% Speed	0		
						50.0	oz/min		
Auxiliary Control		Hand	Off	Auto	OFF				
Inlet Conveyor		Hand	Off	Auto	OFF				

3. Place the bottom valve in the PROCESS / CALIBRATE position and the top valve in the CALIBRATION position.



FLOW METER CALIBRATION

- From the Treater HOA screen, press the Pump Calibration button. Enter the number of the pump you wish to calibrate and a target run time for the calibration. The longer the run time the more accurate the calibration. USC recommends a minimum of 60 seconds. Place a measuring receptacle under the calibration fitting discharge tube on the top valve. Press the Jog Pump Motor and then a second later press it again. This will turn the pump on and off quickly. This is done to fill the plumbing between the two valves. When liquid stops coming from the tube, dump what is in the receptacle back into the tank and place it back under the tube.

Press the Start button to begin the calibration. When the target run time has elapsed, the pump will shutoff automatically. If for any reason you need to stop the process, press the Stop button. If the calibration is stopped before the target time has elapsed, the operator must start the process over again. Enter the calibration receptacle ounces into the Cal. Tube Total box. Enter the flow meter reading into the Calculated Totalizer box. Press the UPDATE RATIO button and it will automatically update. Closing this screen will stop the calibration process if it has not been completed.

Repeat this process for each pump The ration could be slightly different due to hose wear.

Help	Pump# to Adjust:	1	Chemical Name:	Chemical 1	X
Target Run Time (seconds):	30	Actual Rate (oz/min):	0.0	Jog Pump Motor	
Target Rate (oz/min):	33.3	START STOP			
Rough Est. Total (Fl. oz):	16.63				
Totals			Calibration Ratio		
Cal. Tube Total (Fl. oz):	1.00	Current Ratio:	1.00		
Pump Totalizer (Fl. oz):	1.00	Calculated Ratio:	1.00		
Elapsed Run Time (seconds):	0.0	UPDATE RATIO			
Processing Calibration					

- Repeat the process as necessary and for each different chemical slurry used.

TREATING SEED

1. From the Treater HOA screen, press the Auto All Devices button to place the Actuator, Atomizer, Auger, both Pumps and the Auxiliary Control in Auto. If recipes are being used, the pumps and auxiliary devices will set themselves to Auto base on the active recipe.
2. Next, prime the chemical line to the atomizer. Ensure that the valve on each of the chemical attachment ports on the treater are in the correct position. Press and hold the Prime To Atomizer button. The atomizer will turn on and liquid will begin pumping up to the atomizer. When liquid reaches the atomizer release the Prime to Atomizer button. Leave the valve in the process position.

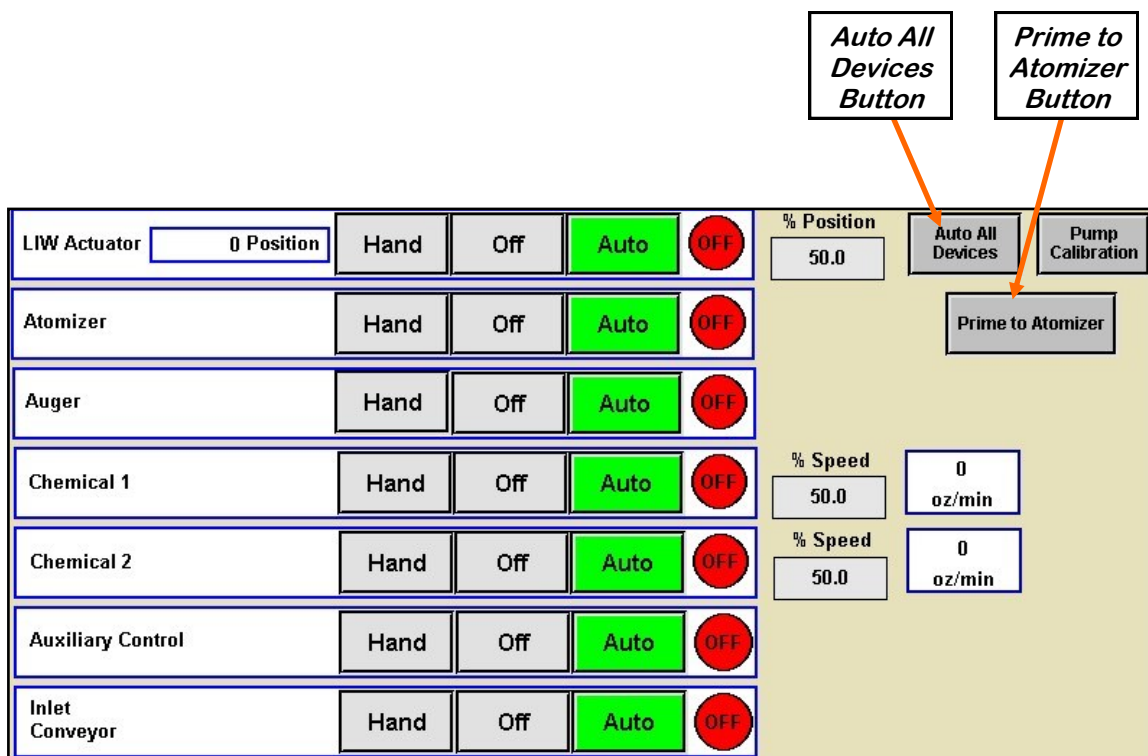

3. Return to the main screen and press the Start Setup button. Press the gray buttons to change the Recipe or Seed Type fields. Press Start to begin the run. The atomizer and auger will turn on. Open the manual gate on the box. When the proximity switch detects seed, a timer will count down the number of seconds the start delay was set for. When that time elapses, the slide gate will open.

AT500H TREATER
TREATING SEED

3. (Continued):

The pump will turn on the same way. Waiting for the pump start delay time defined in the pump profile. The pump may be set to turn on a second or two before seed is flowing to ensure thorough coating of the first seed out of the box. The operator may open the seed gate first so after pressing the start button, the treating processing will begin immediately after the system is up and running. The message bar in the upper left corner will always show what part of the process the system is currently in.

Customer:
John Smith

Chemical Recipe:
Recipe Alpha

Seed Type:
Soybeans

Seed Variety:
Variety 123

Lot Number:
Lot 123

Seeds Per Unit: 140000 lbs Per Unit: 48.11

Start

4. As the seed is being treated, the main screen will display the box weight and the liquid flow rate. If the system needs to be stopped for a moment, the Pause button may be pressed to temporarily stop the process. When ready to begin again, press the Continue button on the Continue / Terminate popup screen.
5. When all seed passes through the slide gate it will close and the pumps will turn off. When more seed is fed into the treater, the treating process will continue.
6. After all seed has been treated the pumps will shut off. However, the atomizer, auger will still be running. When there is no more seed discharging from the auger, press the Shutdown button at the bottom of the screen (see page 53). The auger will continue to run for the number of seconds defined on the Utilities screen and then stop. Remove the treated box and replace it with an empty one. Place a box of untreated seed on the scale and open the manual gate. Go to the Start Setup screen to continue treating.

AT500H TREATER
TREATING SEED

Customer	John Smith	Chemical 1	2.00 oz/SCU	ON
Recipe	Recipe Alpha		32.15 oz/min	
Seed Name	Soybeans	Chemical 2	1.25 oz/SCU	ON
Variety	Variety 123		20.37 oz/min	
Lot Number	Lot 123	Box Weight	2120.0 lb	
Seeds/lb	2910	Totalizer	394 lb	
		Flow Rate	774 lb/min	
		Run Time	31 s	

Pause Button

Shutdown Button

SECTION F TROUBLESHOOTING

TROUBLESHOOTING

Below is a table describing the most frequent problems and solutions with the USC AT500H Treater . For further assistance, contact your authorized dealer.

Problem	Possible Cause	Solution
Seed Gate Actuator will not move.	<ol style="list-style-type: none"> Adjustable Chamber mechanism jammed with debris. One or both of the two connectors linking the actuator to the control panel are not connected. 	<ol style="list-style-type: none"> Clear all debris and make sure mechanism moves freely. Make sure both connectors are properly engaged.
Seed Gate Actuator will not return to the closed position after all seed has emptied from the box.	<ol style="list-style-type: none"> Proximity switch is dirty. Proximity switch is set too sensitive. The system is running in HAND mode. 	<ol style="list-style-type: none"> Clean proximity switch. Adjust the pump proximity switch sensitivity (see page 58). Change to AUTO mode.
Seed Gate Actuator will not move in AUTO.	<ol style="list-style-type: none"> Proximity switch is not staying covered. Proximity switch is not set sensitive enough. HMI screen not set to AUTO. 	<ol style="list-style-type: none"> Make sure proximity switch is staying covered with seed. Adjust pump proximity switch sensitivity by turning the adjustment screw clockwise. Set HMI screen to AUTO.
Seed Gate Actuator will not close completely.	<ol style="list-style-type: none"> Debris may be keeping it from closing completely. 	<ol style="list-style-type: none"> Open the seed gate, remove debris and power cycle the entire system. When the system is turned back on, the gate will automatically close and find it's Home position.
Auger overload keeps tripping	<ol style="list-style-type: none"> Seed flow is too high. Too much liquid being applied. 	<ol style="list-style-type: none"> Slow down seed flow. Lower the liquid rate.

AT500H TREATER

Problem	Possible Cause	Solution
Flow Meter is fluctuating	<ol style="list-style-type: none"> 1. Pump is sucking air. 2. Restriction in the line. 3. Flow meter is not full of liquid 	<ol style="list-style-type: none"> 1. Check and tighten all hose connections. 1. Check filter to see if gasket is missing or cracked. 2. Clean out filter and lines to check for any debris. 3. The meter will fluctuate if there is nothing pumping and there is some liquid left in the meter. Drain out liquid.
Flow meter won't turn on	<ol style="list-style-type: none"> 1. Improper power going to flow meter. 2. Loose connection. 	<ol style="list-style-type: none"> 1. Check incoming power to flow meter. 2. Check connections inside the control panel and inside the flow meter.
Flow Meter is reading too low or too high.	<ol style="list-style-type: none"> 1. Restriction in Flow Meter or in line. 2. Air in treatment. This can cause the flow meter to read lower than calibrating it using a measuring cup. 3. Seed flow has changed. 	<ol style="list-style-type: none"> 1. Flush the flow meter with water or use compressed air and blow air backwards through the meter. 2. Check and tighten all hose connections. 2. Check filter to see if gasket is missing or cracked. 3. Recheck seed flow rate.
Flow meter will not zero	<ol style="list-style-type: none"> 1. Improper wiring 2. Wrong parameter programmed into flow meter 	<ol style="list-style-type: none"> 1. Check wiring schematic. 2. Check flow meter parameters. Call local dealer.

AT500H TREATER

Problem	Possible Cause	Solution
Pump will not turn off in AUTO when seed runs out.	<ol style="list-style-type: none"> 1. Proximity switch is dirty. 2. Proximity switch is set too sensitive. 	<ol style="list-style-type: none"> 1. Clean proximity switch 2. Adjust the pump proximity switch sensitivity by turning adjustment screw counter-clockwise (page 58).
Pump will not turn on in AUTO	<ol style="list-style-type: none"> 1. Proximity switch is not staying covered. 2. Proximity switch is not sensitive enough. 	<ol style="list-style-type: none"> 1. Make sure proximity switch is staying covered with seed. 2. Adjust pump proximity switch sensitivity by turning the adjustment screw clockwise (page 58).
Pump is fluctuating.	<ol style="list-style-type: none"> 1. Restriction in tubing 2. Filter is plugged or missing gasket. 3. Hoses are worn out. 	<ol style="list-style-type: none"> 1. Flush tubing and check filter for any restrictions. 2. Clean filter and check for gasket. 3. Replace hoses.

PROXIMITY SWITCH ADJUSTMENT GUIDE

If a proximity switch is not working properly, this can be caused by wear, dust, or even moisture. The first step is to clean the lens of the proximity switch. If this does not solve the problem, the next step would be to adjust the sensitivity of the proximity switch.

The LED lights indicates the power status. If they are active the device is powered.

The center LED is when the switch closes.

Using the small screwdriver, you can adjust the proximity switch by turning the sensitivity dial of the proximity switch.

- Turn Clockwise to make the proximity switch more sensitive.
- Turn Counterclockwise to make the proximity switch less sensitive.



MAINTENANCE

SECTION G

Proper maintenance of the AT500H Treater is critical for peak performance, reliability and accuracy of this system. The following is a guideline for the type of maintenance and servicing that should be performed on this unit. Your environment and uses may require additional maintenance and service beyond this list to assure a reliable and safe unit. The operator of this unit has ultimate responsibility to identify areas of concern and rectify them before they become a hazard or safety issue. There is no substitute for a trained, alert operator.

**DANGER**

Do not put this unit into operation with any questionably maintained parts. Poor performance or a hazard may occur.

GREASING

Use an SAE multipurpose high temperature grease with extreme pressure (EP) performance. Also acceptable is an SAE multipurpose lithium-based grease.

1. Use a Maintenance Checklist to keep record of all scheduled maintenance.
2. Use a hand-held grease gun for all greasing.
3. Wipe grease fitting with a clean cloth before greasing to avoid injecting dirt and grit.
4. Replace and repair broken fittings immediately.

NOTICE

If fittings will not take grease, remove and clean thoroughly. Also clean lubricant passageway. Replace fitting if necessary.

ELECTRICAL PANEL

1. Check and tighten wire connections.
2. Check quick connects on bottom of control panel.
3. Check to see if relays, timers and/or breakers are tripped.
4. Check and set the proximity switches (see page 58).
5. Check quick connects on end of Auxiliary cord.
6. Check and tighten wire connections.
7. Check relay and fuse holder.
8. Check power cords for cuts or frays and ensure ground is present.

AT500H TREATER

ATOMIZER

To access the inside of the atomizer housing, disconnect the motor power cable from the atomizer motor, push up on the quick release handle and slide out the atomizer. After completing maintenance, slide the atomizer back into the operating position, pull down quick release handle to lock it in place and reconnect the motor power cord.

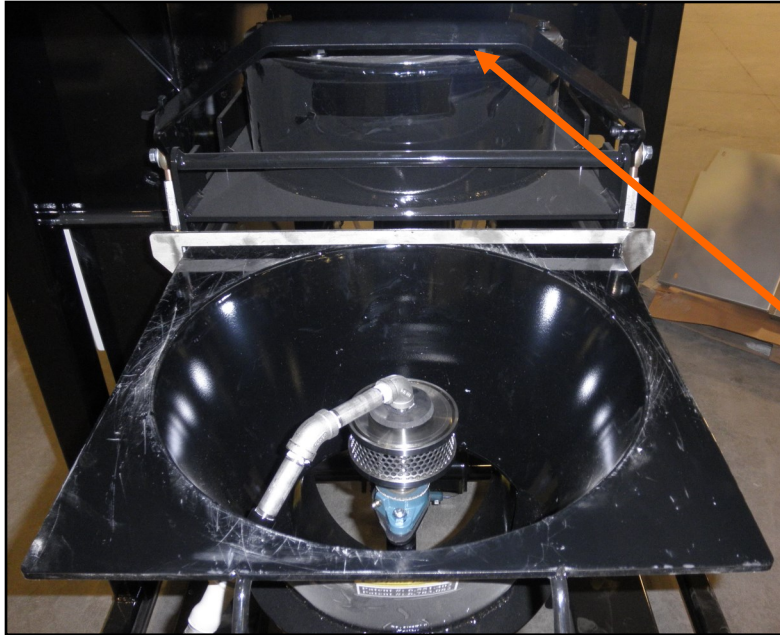

Quick-Release Handle

Atomizer Head

1. Slide out atomizer housing and grease bearing inside. Bearing needs just one pump of grease every 40 hours of operation (right).
2. Clean any build up inside the housing and the atomizer head. To remove the atomizer head, loosen the set screw located on the bottom of the head.
3. Check for any play in the atomizer shaft.
4. Make sure the atomizer spins smoothly.
5. Ensure the adjustable chute is fitting completely into the drum opening. Adjust if necessary.

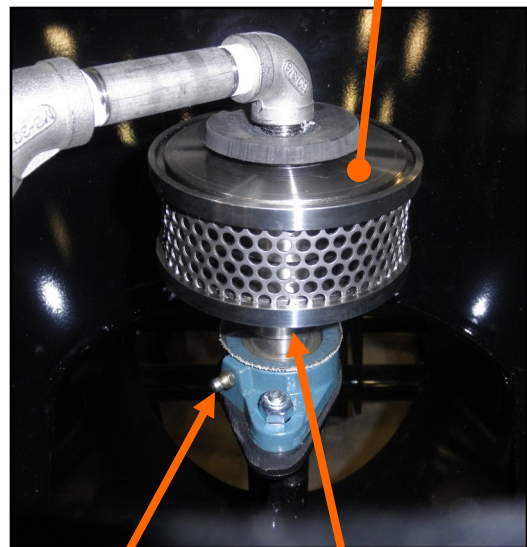

Bearing

Set Screw

DRIVE BELT TENSION & ALIGNMENT

Power to the auger belt is transmitted through a V-belt. The V-belt drive system must be maintained at the proper belt tension and pulley alignment to obtain the desired performance and life. When maintaining the belt drive system for the electric drive model, follow this procedure:

NOTICE

Turn motor off and unplug power cord or turn off power and lock out the master panel before starting maintenance on drive belt system.

Drive Belt Tension

1. Push on the center of the belt span with a force of approximately 5 to 10 lbs.
2. Follow the belt tensioning specification on page 62 to determine proper belt deflection.
3. Move the motor up, using the adjustment bolts, to set drive belt tension (right).
4. Close and secure guards.

Drive Belt Alignment

1. Lay a straightedge across the pulley faces to check the alignment (right).
2. Use the pulley hub or the motor mounting plate slots to move the pulley to the required position for alignment.
3. Tighten hub bolts to secure pulley on shaft.
4. Check belt tension
5. Close and secure guards.

Drive Belt Replacement

1. Lower motor to its loosest position.
2. Remove old belt and replace with a new one.
3. Raise motor to set the belt tension.
4. Check pulley alignment. Adjust if required.
5. Close and secure guards.



Motor base adjustment

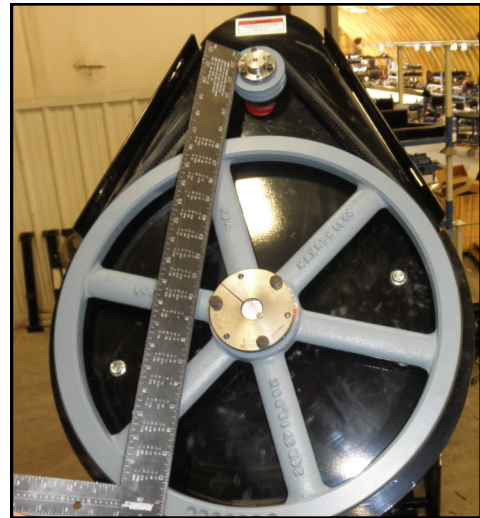

Lay a straightedge across pulley faces

AT500H TREATER

V-Belt tensioning adjustment can be made using a tension meter or other type spring scale using the following procedure. After seating the belts in the groove and adjusting center distance so as to take up the slack in the belts, further increase the tension until only a slight bow on the slack side is apparent while the drive is operating under load. Stop the drive and using the meter, measure the force necessary to depress one of the center belts 1/64 inch for every inch of belt span (see sketch below). For example, a deflection for a 50 inch belt span is 50/64 or 25/32 inch. The amount of force required to deflect the belt should compare with the deflection forces noted in the table below. Also notice for V- Belts that deflection forces vary from the initial RUN - IN values which are greater (reflecting higher run-in tensioning) to the NORMAL values for after the run-in period.

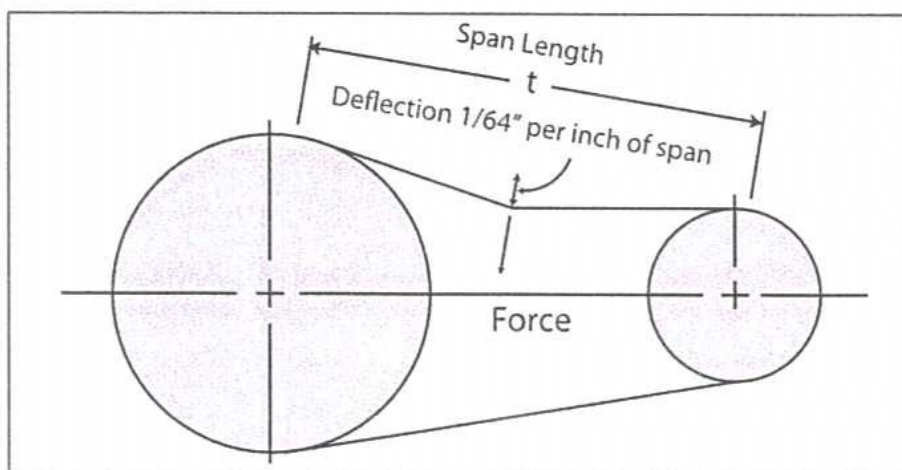

MEASURE THE SPAN LENGTH "T" AS SHOWN IN THE SKETCH ABOVE.

BELT CROSS SECTION	SMALLER PULLEY DIAMETER RANGE (inches)	DEFLECTION FORCE	
		RUN - IN (lbs.)	NORMAL (lbs.)
AX	3.0 - 3.6	4 - 1/8	2 - 3/4
	3.8 - 4.8	5	3 - 1/4
	5.0 - 7.0	6	4
BX	3.4 - 4.2	5 - 1/4	3 - 1/2
	4.4 - 5.2	7 - 1/8	4 - 3/4
	5.4 - 9.4	9	6

PUMPS - PLUMBING - FLOW METER

1. Check pump in forward and reverse.
2. Make sure pump heads open and close smoothly.
3. Inspect tubing for uneven wear. Replace pump tubing often to ensure high flow rates can be achieved.
4. Make certain the inside of the tank is completely drained of chemical. Use clean water to rinse out all chemical residue, then fill the tank with clean water.
5. Disconnect the discharge process lines from the treater static mixer assembly and direct them to a receptacle large enough to hold all of the water from the mix tank.
6. Pump clean water through all areas of the plumbing and flow meter. Opening and closing the valves during this process helps to remove residue from the ball valves.
7. Remove and clean the filter.
8. Open all drain points, valves, and filter to let as much of the water drain as possible.
9. Disconnect power to the flow meter.

NOTICE

Only use the vinegar and water solution mixed in these proportions to clean the flow meter. Use of any other cleaners, especially cleaners containing harsh chemicals may permanently damage the sensors and seals inside the flow meter.

PUMPS - PLUMBING

10. Remove the flow meter from the machine for additional cleaning.

- A. Pre - Mix a solution of 90% water and 10% distilled white vinegar.
- B. Use a size - matched circular brush with soft plastic bristles. Dip the brush in the solution and gently move it up and down in the measuring pipe to avoid damaging the measuring pipe and sensor electrodes.
- C. Re-peat brushing with fresh fluid until measuring pipe is visually clean.
- D. Flush the flow meter inside and out with clean water to remove any of the cleaning solution residue.



When storing the AT500H Seed Treater for long periods of time, the following procedure must be followed to reduce the chance of rust, corrosion and fatigue of the treater. You can also use these steps when storing the machine for the winter.



A dust mask and protective rubber gloves shall be used when cleaning the machine.

ATOMIZER CHAMBER

1. Remove and clean the atomizer housing.
2. Remove the atomizer head and stainless steel plumbing. The atomizer head can be disassembled (right), for easier cleaning. It is threaded together and can simply be unscrewed.
3. Reinstall the atomizer head and plumbing. Grease the bearing and spin the atomizer head a few times to ensure all grease has been worked into the bearings.

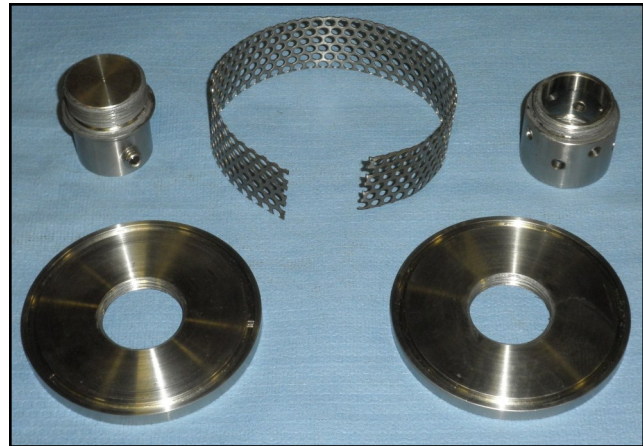

AUGER

1. Grease upper and lower bearings on auger.
2. Remove shield and check tension on belt.
3. Open the bottom clean out door to remove any debris (compressed air can be used).

FINAL

1. Store the machine inside a protective building to keep it from being exposed to the weather.
2. Disconnect power to the machine.
3. Ensure all guards and safety labels are in place.

AT500H TREATER

Proper Storage of the treater for long periods of time is critical to reduce the chance of rust, corrosion and fatigue of the equipment. This is especially true when storing the treater in below freezing temperatures.

The following is a guideline for the type of cleaning and maintenance that should be performed on this unit prior to storage. Your environment and uses may require additional cleaning and preparation to assure that when the equipment is returned to production, it performs in a safe, accurate and reliable manor.



A dust mask and protective rubber gloves shall be used when cleaning the machine.

PUMPS - PLUMBING - FLOW METERS

1. Perform steps 1 through 9 on page 63 in the pumps and plumbing section of the maintenance section to clean the chemical residue from each pump.

NOTICE

If the treater will be exposed to possible freezing temperatures, the final flush of the system should be made with a non freezable liquid like recreational vehicle antifreeze.

2. Release pump heads and remove tubing to prevent any unnecessary wear (see page 19).
3. Disconnect power to the volumetric flow meter and perform steps 10A through 10D on page 64 in the maintenance section.
4. Stand the flow meter upright allowing enough time for measuring pipe to air dry. After it is dry, cover both openings.
6. Store flow meters in a location with the following conditions:
 - Ambient temperature of 50 to 80 degrees Fahrenheit.
 - Protection from direct sunlight to avoid unacceptable high surface temperatures.
 - Where moisture does not collect in or on the flow meter. This will help prevent fungus or bacteria infestation which can damage the liner.
 - Store in a manner so that the inlet and outlet are as much in an up and down position as possible.

AT500H TREATER

NOTES:

SECTION I USC LIMITED WARRANTY

USC, LLC, (Manufacturer) warrants its seed treating equipment as follows:

1. **Limited Warranty:** Manufacturer warrants that the Products sold hereunder will be free from defects in material and workmanship for a period of 18 months from date of shipment. If the Products do not conform to this Limited Warranty during the warranty period, Buyer shall notify Manufacturer in writing of the claimed defects and demonstrate to Manufacturer satisfaction that said defects are covered by this Limited Warranty. If the defects are properly reported to Manufacturer within the warranty period, and the defects are of such type and nature as to be covered by this warranty, Manufacturer shall, at its expense, furnish replacement Products or, at Manufacturer's option, replacement parts for the defective products. Shipping and installation of the replacement Products or replacement parts shall be at the Buyer's expense.
2. **Other Limits:** THE FOREGOING IS IN LIEU OF ALL OTHER WARRANTIES, EXPRESSED OR IMPLIED, INCLUDING BUT NOT LIMITED TO THE IMPLIED WARRANTIES OF MERCHANTABILITY AND FITNESS FOR A PARTICULAR PURPOSE. Manufacturer does not warrant against damages or defects arising from improper installation (where installation is by persons other than Manufacturer), against defects in products or components not manufactured by Manufacturer, or against damages resulting from such non-Manufacturer made products or components. Manufacturer passes on to the Buyer the warranty it received (if any) from the maker of such non-Manufacturer made products or components. This warranty also does not apply to Products upon which repairs and / or modifications have been effected or attempted by persons other than pursuant to written authorization by Manufacturer. This includes any welding on equipment which could damage electrical components. Manufacturer does not warrant against casualties or damages resulting from misuse and / or abuse of Products, improper storage or handling, acts of nature, effects of weather, including effects of weather due to outside storage, accidents, or damages incurred during transportation by common carrier.
3. **Exclusive Obligation:** THIS WARRANTY IS EXCLUSIVE. The sole and exclusive obligation of Manufacturer shall be to repair or replace the defective Products in the manner and for the period provided above. Manufacturer shall not have any other obligation with respect to the Products or any part thereof, whether based on contract, tort, strict liability or otherwise. Under no circumstances, whether based on this Limited Warranty or otherwise, shall Manufacturer be liable for lost profits, lost revenue, lost sales (whether direct or indirect damages), incidental, special, punitive, indirect or consequential damages.
4. **Other Statements:** Manufacturer's employees or representatives' oral or other written statements do not constitute warranties, shall not be relied upon by Buyer, and are not a part of the contract for sale or this limited warranty.
5. **Return Policy:** Approval is required prior to returning goods to Manufacturer. A restocking fee will apply.
6. **Entire Obligation:** This Limited Warranty states the entire obligation of Manufacturer with respect to the Products. If any part of this Limited Warranty is determined to be void or illegal, the remainder shall remain in full force and effect.

US / Canada Non-Exclusive 2016

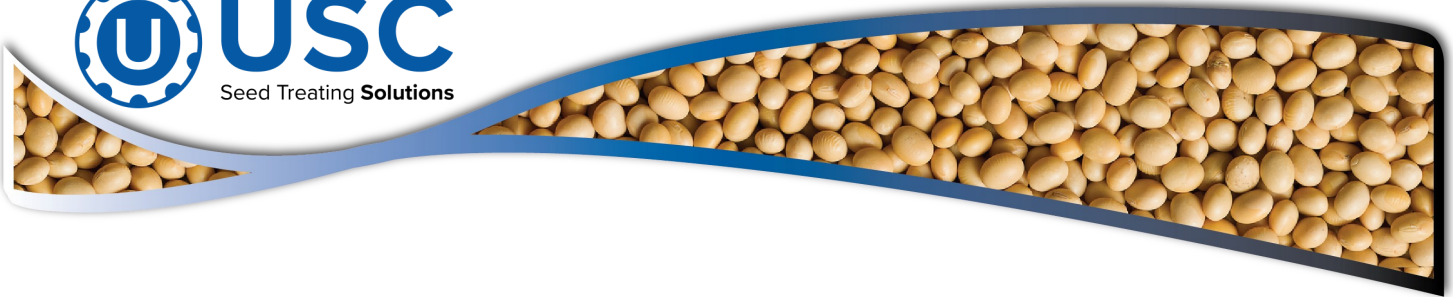

DOCUMENT REVIEW RECORD	
DATE	BY
07-2020	BT
08-20-2020	BT

USC, LLC

2320 124th Road

Sabetha, KS 66534

Phone (785) 431-7900

EMAIL: sales-team@uscllc.com

WEB: www.uscllc.com