

U-Treat Automation

Operators Manual

**Covering automation for the
Seed Wheel and LIW Treaters,
Batch Hopper and Tri - Flo®**

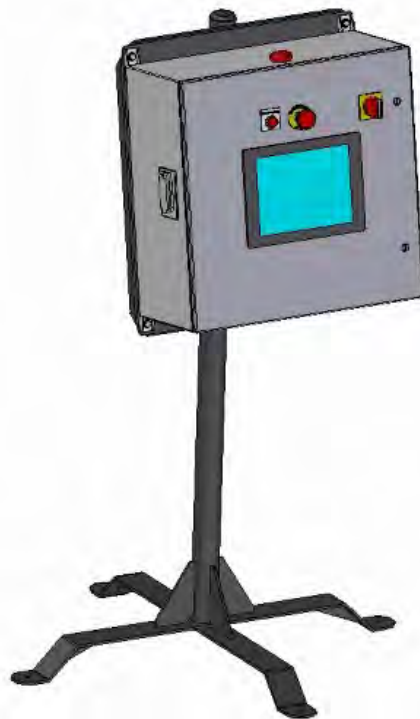

Software Release: U-Treat v3.6

Document: TD-09-06-1041

Revision: E

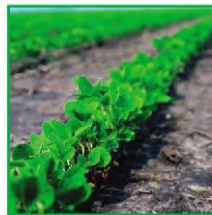

TABLE OF CONTENTS

<u>Section</u>	<u>Contents</u>	<u>Page #</u>
Section A	Safety Instructions	6
Section B	Installation	16
Section C	Electrical Operation	19
	C-1 General Automation	21
	• USC Startup Screen	21
	• H-O-A Screen	22
	• Utilities Screen.....	24
	• Security Screen.....	25
	• Tools & Options Screen	26
	C-2 LP, MP, LX, MX, LPX & LPV SMW Treater Automation... 40	
	• Main Screen	40
	• H-O-A Screen.....	44
	• Utilities Screen	51
	C-3 LPV LIW Treater Automation.....	54
	• Main Screen	54
	• H-O-A Screen.....	59
	• Utilities Screen	66
	C-4 Batch Hopper Automation	69
	• Main Screen.....	69
	• H-O-A Screen	73
	• Utilities Screen.....	78
	C-5 Tri - Flo ® Automation	80
	• Main Screen.....	80
	• H-O-A Screen	85
	• Utilities Screen.....	90
Section D	Calibration & Operation	92
	• Determining Seed Cup Weight	92
	D-1 General Calibration & Operation.	94
	• Viewing & Printing Reports	94
	• Downloading Reports.....	97
	D-2 Treater Calibration & Operation.....	98
	• Seed Flow Calibration for Treater with Seed Wheel	98
	• Seed Flow Calibration for Treater with Loss in Weight ..	100

<u>Section</u>	<u>Contents</u>	<u>Page #</u>
Section D	Calibration & Operation	(con't)
	• Pump Calibration	102
	• Flow Meter Calibration	103
	• Loss In Weight Flow Calibration	105
	• Loss In Weight Scale Calibration	107
	• Seed Wheel Calibration	111
	• Treating Seed with Seed Wheel	112
	• Treating Seed with Loss in Weight	114
D-3	Batch Hopper Calibration & Operation	116
	• Loading Seed into Bins	116
	• Setting Seed Flow Rate	118
	• Scale Fill from Bin	120
	• Calling Seed from Pro Boxes	122
	• Batch Hopper Calibration	124
	• Underbin Operation in Reverse	125
D-4	Tri - Flo ® Calibration & Operation	126
	• Loading Seed into Bins	126
	• Setting Seed Flow Rate	128
	• Scale Fill from Bin	130
	• Calling Seed from Pro Boxes	132
	• Tri - Flo ® Calibration	134
	• Underbin Operation in Reverse	135
Section E	Troubleshooting & Alarms	136
	• Alarm Log Screen	137
E-1	Treater Troubleshooting	138
	• LPX & LPV Troubleshooting Table	138
	• LPV LIW Only Troubleshooting Table	140
	• Proximity Switch Adjustment Guide	141
	• LPX & LPV System Alarms-Faults Table	142
	• LPV LIW Only System Alarms-Faults Table	145
	• System Messages	146
E-2	Batch Hopper Troubleshooting	147
	• Troubleshooting Table	147
	• System Alarms-Faults Table	149
	• System Messages	151
E-3	Tri - Flo ® Troubleshooting	152
	• Troubleshooting Table	152
	• System Alarms-Faults Table	155
	• System Messages	157
Section F	Mechanical Drawings	158
Section G	Limited Warranty	165



INTRODUCTION

Thank you for choosing USC, LLC for your equipment needs. We appreciate your business and will work diligently to ensure that you are satisfied with your choice.

OVERVIEW

The purpose of this manual is to provide you with the basic information needed to operate and maintain the U-Treat Automation. It does not hold USC, LLC liable for any accidents or injuries that may occur.

The technical information provided in this document is based on extensive testing under controlled conditions at the USC research and development facility. This information is given without guarantee as the conditions of operation and storage of the equipment are beyond our control. Variables such as temperature, humidity, viscosity of chemical products and changes in seed size or variety may all effect the accuracy of application and seed coverage. Periodically check the equipment calibration while treating and make adjustments as required. This will insure the optimum seed coverage.

OPERATOR RESPONSIBILITIES

As the purchaser/owner/operator of this equipment and control system, you have an obligation to install, operate, and maintain the equipment in a manner that minimizes the exposure of people in your care to any potential hazards inherent in using this equipment. It is critical that the owner of this equipment:

- Has a clear and documented understanding of the process this machine is being used in and of any resulting hazards or special requirements arising from this specific application.
- Allow only properly trained and instructed personnel to install, operate or service this equipment.
- Maintain a comprehensive safety program involving all who work with this machine and other associated process equipment.
- Establish clear areas of staff responsibility (e.g. operation, setup, sanitation, maintenance, and repairs).
- Provide all personnel with necessary safety equipment.
- Periodically inspect the equipment to insure that the doors, covers, guards, and safety devices are in place and functioning, that all safety instructions and warning labels are intact and legible, and that the equipment is in good working order.
- In addition to the operating instructions, observe and enforce the applicable legal and other binding regulations, national and local codes.

As the person with the most to gain or lose from working safely, it is important that you work responsibly and stay alert. By following a few simple rules, you can prevent an accident that could injure or kill you or a co-worker.

- Disconnect, lockout, and tagout electrical and all other energy sources before inspecting, cleaning, servicing, repairing, or any other activity that would expose you to the hazards of electrical shock.
- Do not operate, clean, or service this equipment until you have read and understood the contents of this manual. If you do not understand the information in this manual, bring it to the attention of your supervisor, or call USC at (785) 431-7900 for assistance.
- Any operator who is known or suspected to be under the influence of alcohol or drugs should not be allowed to operate the equipment.
- Understand and follow the safety practices required by your employer and this manual.
- **PAY ATTENTION** to what you and other personnel are doing and how these activities may affect your safety.
- **Failure to follow these instructions may result in serious personal injury or death.**

RECEIVING YOUR EQUIPMENT

As soon as the equipment is received, it should be carefully inspected to make certain that it has sustained no damage during shipment and that all items listed on the packing list are accounted for. If there is any damage or shortages, the purchaser must immediately notify USC, LLC. Ownership passes to purchaser when the unit leaves the USC, LLC. premises. The purchaser is responsible for unloading and mounting all components of the equipment.

Document the serial number of the machine for future reference. The serial number is located on the upper right hand corner of the main control panel.

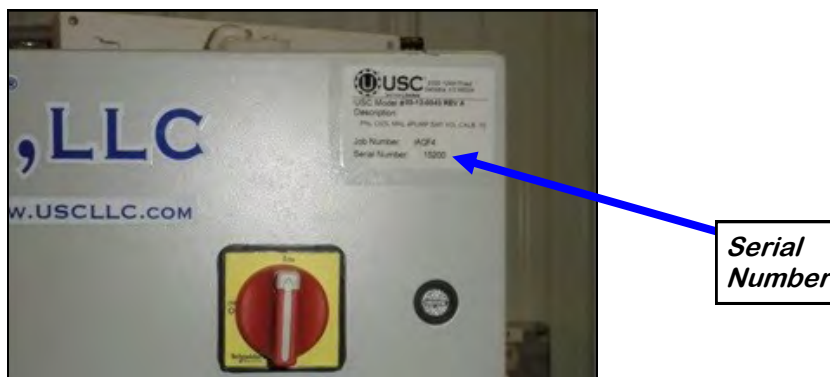

SERIAL NUMBER: _____

**SECTION
A****SAFETY INSTRUCTIONS**

Every year accidents in the work place maim, kill and injure people. Although it may be impossible to prevent all accidents, with the right combination of training, operating practices, safety devices, and operator vigilance, the number of accidents can be significantly reduced. The purpose of this section is to educate equipment users about hazards, unsafe practices, and recommended hazard avoidance techniques.

If any of the required regularly scheduled maintenance is located above the reach of the operator, they should follow the companies normal safe practices of reaching that particular height, utilizing the companies specified equipment and following normal safety precautions.

When working with treatment chemicals, operators should always wear protective gloves, safety glasses, and follow the companies safety precautions in the case of any spillage or operator contamination.

SAFETY WORDS AND SYMBOLS

It is very important that operators and maintenance personnel understand the words and symbols that are used to communicate safety information. Safety words, their meaning and format, have been standardized for U.S. manufacturers and published by the American National Standards Institute (ANSI). The European Community (E.C.) has adopted a different format based on the International Standards Organization (I.S.O.) and applicable machinery directives. Both formats are presented below. Graphic symbols are not standardized, but most manufacturers will use some variation of the ones seen in this manual.

MOTS ET SYMBOLES SÉCURITÉ

Il est très important que les opérateurs et le personnel d'entretien à comprendre les mots et les symboles qui sont utilisés pour communiquer des informations de sécurité. Mots de sécurité, de leur signification et le format, ont été normalisés pour les fabricants américains et publié par l' American National Standards Institute (ANSI). La Communauté européenne (CE) a adopté un format différent sur la base de l'Organisation internationale de normalisation (ISO) et des directives de machines applicables. Les deux formats sont présentés ci-dessous. Les symboles graphiques ne sont pas standardisés, mais la plupart des fabricants utilisent une variante de ceux observés dans ce manuel.



Indicates an imminently hazardous situation which, if not avoided, **will** result in death or serious injury.



Indique une situation extrêmement dangereuse qui, si pas évitée, entraînera la mort ou des blessures graves.



Indicates a potentially hazardous situation which, if not avoided, **could** result in death or serious injury.



Indique une situation potentiellement dangereuse qui, si pas évitée, pourrait entraîner la mort ou des blessures graves.



Indicates a potentially hazardous situation which, if not avoided, **may** result in minor or moderate injury and/or property damage.



Indique une situation potentiellement dangereuse qui, si pas évitée, peut entraîner des blessures mineures ou modérées et / ou des dommages.



Provides additional information that the operator needs to be aware of to avoid a potentially hazardous situation.



Fournit des informations supplémentaires que l'opérateur doit être conscient de d'éviter une situation potentiellement dangereuse.



Notice is used to notify people of important installation, operation or maintenance information which is not hazard related.



Avis est utilisé pour informer les gens des informations de maintenance qui ne est pas danger lié importante installation, l'exploitation ou.



Mandatory Lockout Power Symbol. Disconnect, lockout and tagout electrical and other energy sources before inspecting, cleaning or performing maintenance on this panel.

Symbole de puissance verrouillage obligatoire. Débranchez, de verrouillage et de déconsignation énergie électrique et d'autres sources avant d'inspecter, de nettoyage ou de la maintenance de ce panneau.



International Safety Alert Symbol. The exclamation point (!) surrounded by a yellow triangle indicates that an injury hazard exists. However, it does not indicate the seriousness of potential injury. The exclamation point (!) is also used with the DANGER, WARNING and CAUTION symbols so the potential injury is indicated.

Sécurité Symbole International Alert . Le point d'exclamation (!) Entouré par un triangle jaune indique que un risque de blessure existe . Cependant, il ne indique pas la gravité des blessures potentielles. Le point d'exclamation (!) Est également utilisé avec les symboles DANGER, AVERTISSEMENT et ATTENTION de sorte que le risque de blessure est indiqué.



Electrocution Hazard Symbol. This symbol indicates that an electrocution hazard exists. Serious injury or death could result from contacting high voltage.

Symbole de danger d'électrocution . Ce symbole indique qu'un danger d'électrocution existe. Des blessures graves ou la mort pourraient résulter de contact haute tension.



International Electrocution Hazard. This symbol indicates that an electrocution hazard exists. Serious injury or death could result from contacting high voltage.

Danger d'électrocution international. Ce symbole indique qu'un danger d'électrocution existe. Des blessures graves ou la mort pourraient résulter de contact haute tension.



Mandatory Read Manual Action Symbol. (I.S.O. format) This symbol instructs personnel to read the Operators Manual before servicing or operating the equipment.

Obligatoire Lire Symbole d'action Manuel. (Format ISO)
Ce symbole indique le personnel de lire le manuel de l'opérateur avant de réparer ou d'utiliser l'équipement.



Mandatory Read Manual Action Symbol. This symbol instructs personnel to read the Operators Manual before servicing or operating the equipment.

Obligatoire Lire Symbole d'action Manuel . Ce symbole indique le personnel de lire le manuel de l'opérateur avant de réparer ou d'utiliser l'équipement.

LOCKOUT / TAGOUT PROCEDURES

Lockout/Tagout is the placement of a lock/tag on an energy isolating device in accordance with an established procedure. When taking equipment out of service to perform maintenance or repair work, always follow the lockout / tagout procedures as outlined in ANSI Z344.1 and/or OSHA Standard 1910.147. This standard “requires employers to establish a program and utilize procedures for affixing appropriate lockout devices or tagout devices to energy isolating devices and to otherwise disable machines or equipment to prevent unexpected energizing, start-up, or release of stored energy in order to prevent injury to employees.”

LES PROCEDURES DE VERROUILLAGE / ETIQUETAGE

Verrouillage / étiquetage est le placement d'un verrouillage / tag sur un dispositif d'isolement de l'énergie conformément à une procédure établie. Lors de la prise hors service des équipements pour effectuer la maintenance ou de réparation, toujours suivre les procédures de verrouillage / débranchement comme indiqué dans la norme ANSI Z344.1 et / ou la norme OSHA 1910.147. Cette norme "oblige les employeurs à établir un programme et appliquer des procédures pour la fixation des dispositifs de verrouillage appropriés ou des dispositifs déconsignation à l'énergie dispositifs d'isolement et d' autre machines ou équipements désactiver pour éviter énergisant inattendu, start-up, ou la libération de l'énergie stockée dans le but de prévenir les blessures aux employés."

EMERGENCY STOP



There is an Emergency Stop push button on all LPV and LPX Seed Treaters which is located on the Treater Control Panel. The LPX Automated Treater has an additional Emergency Stop pushbutton on the Main Control Panel. Actuators of emergency stop shall be colored RED. The background immediately around the device actuator shall be colored YELLOW. The actuator pushbutton operated device shall be of the palm or mushroom head type.

ARRET D'URGENCE

Il ya un bouton-poussoir d'arrêt d'urgence sur tous les traiteurs de semences LPX qui est situé sur le Panneau de configuration Traiteur. Le LPX automatisé Traiteur dispose d'une autre arrêt d'urgence bouton poussoir sur le panneau de commande principal. Actionneurs de freinage d'urgence doivent être de couleur rouge. Le fond immédiatement autour de l'actionneur de l'appareil doit être de couleur JAUNE. Le dispositif actionné actionneur de bouton-poussoir doit être de la paume ou champignons type de tête.

CONTROLLED STOP

This is the stopping of machine motion by reducing the electrical command signal to 0 (zero) once the stop signal has been recognized.

ARRET CONTROLÉ

Ce est l'arrêt du mouvement de la machine en réduisant le signal de commande électrique à 0 (zéro) dès que le signal d'arrêt a été reconnu.

HAZARD REVIEW

RISQUE EXAMEN



Electrocution Hazard

Electrocution accidents are most likely to occur during maintenance of the electrical system or when working on or near exposed high voltage wiring. This hazard does not exist when the electrical power has been disconnected, properly locked, and tagged out.

Risque d'électrocution

Les accidents d'électrocution sont les plus susceptibles de se produire lors de la maintenance du système électrique ou pour travailler sur ou à proximité du câblage haute tension exposé. Ne existe pas ce danger lorsque l'alimentation électrique a été déconnecté, bien verrouillé et étiquetés sur.

Automatic Start Hazard



! WARNING

This equipment may be controlled by an automated system and may start without warning. Failure to properly disconnect, lockout, and tagout all energy sources of remotely controlled equipment creates a very hazardous situation and could cause injury or even death. PLEASE STAY CLEAR AND BE ALERT.

Démarrer danger automatique

! AVERTISSEMENT

Cet équipement peut être contrôlé par un système automatisé et peut démarrer sans avertissement. Sources de l'équipement contrôlé à distance non débranché correctement, lock-out, et tous déconsignation énergie crée une situation très dangereuse et pourrait causer des blessures ou même la mort. Se IL VOUS PLAÎT rester à l'écart et d'être vigilant.

YOU are responsible for the **SAFE** operation and maintenance of your USC, LLC equipment . **YOU** must ensure that you and anyone else who is going to operate, maintain or work around the equipment be familiar with the operating and maintenance procedures and related **SAFETY** information contained in this manual. This manual will take you step-by-step through your working day and alert you to good safety practices that should be adhered to while operating the equipment

Remember, **YOU** are the key to safety. Good safety practices not only protect you, but also the people around you. Make these practices a working part of your safety program. Be certain that **EVERYONE** operating this equipment is familiar with the recommended operating and maintenance procedures and follows all the safety precautions. Most accidents can be prevented. Do not risk injury or death by ignoring good safety practices.

- Equipment owners must give operating instructions to operators or employees before allowing them to operate the machine, and at least annually thereafter per OSHA (Occupational Safety and Health Administration) regulation 1928.57.
- The most important safety device on this equipment is a **SAFE** operator. It is the operator's responsibility to read and understand **ALL** Safety and Operating instructions in the manual and to follow them. All accidents can be avoided.
- A person who has not read and understood all operating and safety instructions is not qualified to operate the machine. An untrained operator exposes himself and bystanders to possible serious injury or death.
- Do not modify the equipment in any way. Unauthorized modification may impair the function and/or safety and could affect the life of the equipment.
- Think SAFETY! Work SAFELY!

GENERAL SAFETY

1. Read and understand the operator's manual and all safety labels before operating, maintaining, adjusting or unplugging the equipment .
2. Only trained persons shall operate the equipment . An untrained operator is not qualified to operate the machine.
3. Have a first-aid kit available for use should the need arise, and know how to use it.



4. Provide a fire extinguisher for use in case of an accident. Store in a highly visible place.
5. Do not allow children, spectators or bystanders within hazard area of machine.
6. Wear appropriate protective gear. This includes but is not limited to:



- A hard hat
- Protective shoes with slip resistant soles
- Protective goggles
- Heavy gloves
- Hearing protection
- Respirator or filter mask

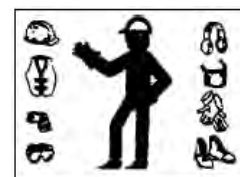

7. Place all controls in neutral or off, stop motor, and wait for all moving parts to stop. Then disable power source before servicing, adjusting, repairing, or unplugging.
8. Review safety related items annually with all personnel who will be operating or maintaining the equipment.



OPERATING SAFETY:

1. Read and understand the operator's manual and all safety labels before using.
2. Disconnect and disable electrical supply completely and wait for all moving parts to stop before servicing, adjusting, repairing or unplugging.
3. Clear the area of bystanders, especially children, before starting.
4. Be familiar with the machine hazard area. If anyone enters hazard area, shut down machine immediately. Clear the area before restarting.
5. Keep hands, feet, hair and clothing away from all moving and/or rotating parts.
6. Stay away from overhead obstructions and power lines during operation and transporting. Electrocutation can occur without direct contact.
7. Do not operate machine when any guards are removed.
8. Inspect welds and repair if needed.

PLACEMENT SAFETY

1. Move only with the appropriate equipment
2. Stay away from overhead power lines when moving equipment. Electrocution can occur without direct contact.
3. Be familiar with machine hazard area. If anyone enters hazard areas, shut down machine immediately. Clear the area before restarting.
4. Operate the equipment on level ground free of debris. Anchor the equipment to prevent tipping or upending.



Before placement of the equipment, be sure that ground is reasonably level. The equipment may topple or work improperly if the ground is too uneven, damaging the equipment and / or causing personal injury.



Avant de placement de l'équipement, assurez-vous que sol est relativement plat. L'équipement peut tomber ou mal fonctionner si le sol est trop inégale, endommager l'équipement et / ou causer des blessures.

MAINTENANCE SAFETY

1. Review the operator's manual and all safety items before working with, maintaining or operating the equipment .
2. Place all controls in neutral or off, stop motors, disable power source, and wait for all moving parts to stop before servicing, adjusting, repairing or unplugging.
3. Follow good shop practices:
Keep service area clean and dry.
Be sure electrical outlets and tools are properly grounded.
Use adequate light for the job at hand.
4. Keep hands, feet, hair and clothing away from all moving and/or rotating parts.
5. Clear the area of bystanders, especially children, when carrying out any maintenance and repairs or making any adjustments.
6. Before resuming work, install and secure all guards when maintenance work is completed.
7. Keep safety labels clean. Replace any sign that is damaged or not clearly visible.



SAFETY LABELS

1. Keep safety labels clean and legible at all times.
2. Replace safety labels that are missing or have become illegible.
3. Replaced parts that displayed a safety label should also display the current label.
4. Replacement safety labels are available. Contact USC at (785) 431-7900 .

How to Install Safety Labels:

- Be sure that the installation area is clean and dry.
- Be sure temperature is above 50°F (10°C).
- Decide on the exact position before you remove the backing paper.
- Remove the smallest portion of the split backing paper.
- Align the sign over the specified area and carefully press the small portion with the exposed sticky backing in place.
- Slowly peel back the remaining paper and carefully smooth the remaining portion of the sign in place.
- Small air pockets can be pierced with a pin and smoothed out using the piece of sign backing paper.



Located on the USC equipment you will find safety labels. Always be sure to read and follow all directions on the labels.



Situé sur l'équipement USC vous trouverez des étiquettes de sécurité. Veuillez à toujours lire et suivre toutes les instructions sur les étiquettes.



Guards provided with USC equipment are to remain in place during operation.



Gardes fournis avec des équipements USC doivent rester en place pendant le fonctionnement.

SECTION
B**INSTALLATION**

HIGH VOLTAGE ~ Always disconnect the power source before working on or near the control panel or lead wires.



HAUTE TENSION ~ Toujours débrancher la source d'alimentation avant de travailler sur ou près du panneau de commande ou les câbles.



HIGH VOLTAGE ~ Use insulated tools when making adjustments while the controls are under power.



HAUTE TENSION ~ Utilisez des outils isolés lors des réglages, tandis que les commandes sont sous tension.



Permanent installation may require additional electrical cords, chemical tubing, and air lines, since each installation is unique.



Installation permanente peut exiger cordons électriques, des tubes supplémentaires chimique, et les conduites d'air, puisque chaque installation est.

USC equipment may operate within a Group II, Division 2, Class G hazardous area which contains seed dust. If so, the equipment must be certified for use in this area. To avoid the possibility of an explosion ignited by static electricity, all USC equipment should be grounded by attaching a bonding strip to the metal frame and securing that strip to the factory ground point.

If labeled accordingly, USC products are designed to comply with CSA 22.1 for use in a Class II, Division 2, Group G environment. When connecting the USC system power cord into a power supply, first determine if the supply is also within the hazardous area where the USC system is located. If so, we recommend that the power be hard wired into the source. Do not use a standard electrical plug for this purpose. For other acceptable methods of connecting to a power source, or any other additional miscellaneous equipment to the USC system within a hazardous location, please consult CSA 22.1, Section 18-200 and 18-274. Review the appropriate section and ensure compliance with one of the options given.

When connecting to USC equipment from a remote location, and the USC equipment is in a hazardous Class II, Group G environment, customers are advised to follow the requirements within CSA 22.2 no. 25. More details may also be found in CSA 22.1 18-252 (wiring methods). There are various options covered within this section for wiring in a Class II, Group G (dust) environment. Select the best method suited for your specific location.

USC équipement peut fonctionner dans un Groupe II, Division 2, Classe G zone dangereuse qui contient la poussière des semences. Si oui, l'équipement doit être certifié pour une utilisation dans ce domaine. Pour éviter la possibilité d'une explosion enflammé par l'électricité statique, tous les équipements USC devrait être la terre en attachant une bande de liaison à la structure métallique et la sécurisation cette bande au point de masse du fabricant.

Si étiquetés en conséquence, les produits USC sont conçus pour être conformes à la norme CSA 22.1 pour une utilisation dans une Classe II, Division 2, Groupe G environnement. Lors du raccordement du USC alimentation du système cordon dans une alimentation, d'abord déterminer si l'offre est également dans la zone dangereuse où se trouve le système USC. Si oui, nous recommandons que le pouvoir soit câblé dans la source. Ne pas utiliser une prise électrique standard à cet effet. Pour les autres méthodes acceptables de se connecter à une source d'alimentation, ou tout autre matériel divers supplémentaire au système USC dans un endroit dangereux, se il vous plaît consulter la norme CSA 22.1, Section 18-200 et 18-274. Consultez la section appropriée et assurer la conformité avec l'une des options proposées.

Lors de la connexion à l'équipement USC depuis un emplacement distant et l'équipement USC est dans une classe dangereuse II, Groupe G environnement, les clients sont invités à suivre les exigences dans CSA 22.2 no. 25. Plus de détails peuvent également être trouvés dans 22,1 CSA 18-252 (Les méthodes de câblage). Il existe diverses options couvertes dans cette section pour le câblage dans une Classe II, Groupe G (poussière) environnement. Sélectionnez la meilleure méthode

INSTALLATION

1. Attach the Main Control Panel to the control panel stand using the provided hardware. Determine the permanent location you will be operating the system from, then anchor the stand to the floor. The panel may also be mounted to a wall.
2. Connect the gray cable with light blue ends to one of PJCAN connectors on the bottom of Main Control Panel to one of the PJCAN connectors on the bottom of the Treater Control Panel. If using with a Tri-Flo® and or Bin Site control panel, continue to daisy chain from one panel to the next until all panels are connected. Connect the two light blue plugs onto each of the remaining open PJCAN connectors on the first and last panel.
3. Connect the red cable to the PJESTOPA on the Main Control Panel and then to the PJESTOPB on the Treater Control Panel. This cable must run from an A connection to a B connection (never A to A or B to B). If using with a Tri-Flo® and or Bin Site control panel, continue to daisy chain from one panel to the next until all panels are connected. Connect the two red plugs onto each of the remaining open PJESTOP connectors on the first and last panel.

INSTALLATION

4. Connect the cables from Pump Stand(s) to applicable port on the Main Control Panel.
5. There is a USB port located on the bottom of the panel that may be used to download reports to a compact flash device. The flash device must be in FAT 32 format.
6. If using a scale printer, plug the printer communication cable into one of the available Ethernet ports located on the bottom of the main control panel. The printer must be located in a safe area. Do not use within a hazardous area which contains seed dust.
6. Si vous utilisez une imprimante à grande échelle, branchez le câble de communication de l'imprimante dans l'un des ports Ethernet disponibles situés sur le bas du panneau de commande principal. L'imprimante doit être situé dans une zone sûre. Ne pas utiliser dans une zone dangereuse qui contient la poussière des.

MAIN CONTROL PANEL

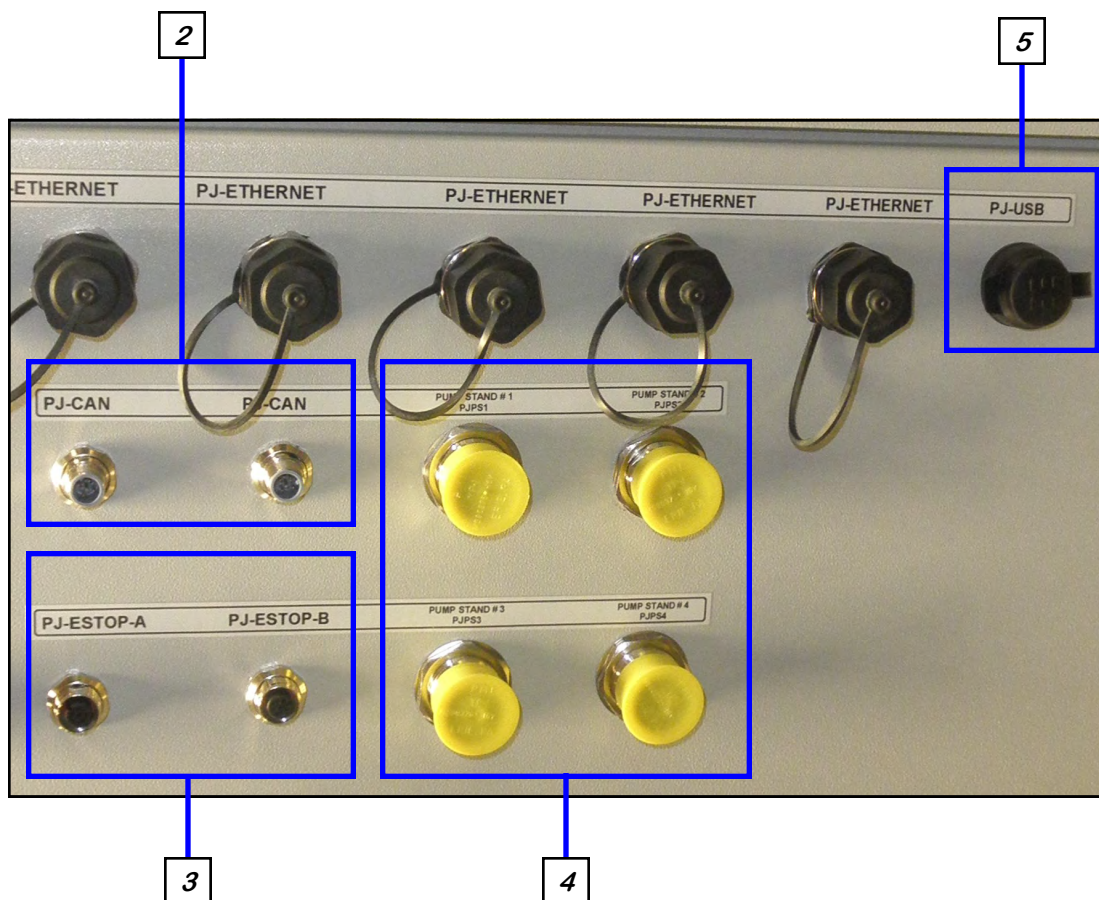

ELECTRICAL OPERATION

SECTION C



HIGH VOLTAGE ~ Always disconnect the power source before working on or near the control panel or lead wires.



HAUTE TENSION ~ Toujours débrancher la source d'alimentation avant de travailler sur ou près du panneau de commande ou les câbles.



HIGH VOLTAGE ~ Use insulated tools when making adjustments while the controls are under power.



HAUTE TENSION ~ Utilisez des outils isolés lors des réglages, tandis que les commandes sont sous tension.



AUTHORIZED PERSONNEL only shall work on the control panel. Never allow anyone who has not read and familiarized themselves with the owner's manual to open or work on the control panels.



Seules personnes autorisées doivent travailler sur le panneau de commande. Ne jamais laisser quelqu'un qui n'a pas lu et se sont familiarisés avec le manuel d'ouvrir ou de travail du propriétaire

This section provides a general overview and description of the operator controls. If any of the panels are located in the hazardous area described in the installation section (see page 16), all 110VAC connections must be hard wired to a listed type 4 rated enclosure.

General Panel Descriptions

- The Automated Main Control Panel is a plug connected enclosure that contains the PLC (Programmable Logic Controller) as well as the HMI (Human Machine Interface) touch screen. The operator is able to control the entire system through the HMI. Power to this panel is supplied from a standard 110V plug (Always on site).
- The Treater Main Panel is an enclosure that is attached to the side of the treater and contains the electrical components required to actuate the seed treater. This includes the VFDs for the seed wheel and atomizer. Power for the treater is supplied here. Power to this panel is hard wired (Always on site).
- The Tri - Flo ® Control Panel (TFCP) is a plug connected enclosure that is located on the Tri - Flo ®. This enclosure contains the electronic components for the Tri - Flo ® (Optional panel-only present with Tri - Flo ® weigh system).

General Panel Descriptions

- The Automated Pump Stand Panel is a plug connected enclosure that is located on each pump stand frame. This panel connects the pump stand electrical components to the Automated Main Control Panel. Each pump stand has two standard 110V plugs. One for the manual ON/OFF switch controlling the mix tank motor and one for the pump stand control panel (Optional panel=pump stand configuration options vary).
- The Bin Site Control Panel (BSCP) is a 36 x 30 x 10 inch enclosure that contains the bulk of the electrical control components. The air solenoid bank that controls the Batch Hopper slide gate valve and the bin slide gate valves is located on the side of this panel and hardwired to the BSCP (Optional panel-only present on sites with bin site).

NOTICE

USC strongly recommends that you implement a routine data export strategy. This will give your company a regularly updated back-up file containing all of the important information in your seed treating system. Customer, seed, bin and chemical profiles, as well as chemical recipes may easily be restored in the event of a catastrophic system failure, such as a lightning strike or PLC failure. Reports may not be imported back into the system, but you will still have an electronic copy for your records. USC recommends daily back-ups (see page 36).

AVIS

USC vous recommande fortement de mettre en œuvre une stratégie de routine d'exportation de données. Cela donnera à votre entreprise un fichier de sauvegarde régulièrement mise à jour contenant toutes les informations importantes dans votre système de traitement des semences. Clients, semences, bin et chimiques profils, ainsi que des recettes chimiques peuvent être facilement restaurées en cas de défaillance catastrophique du système, comme une grève de la foudre ou l'échec PLC. Rapports ne peuvent pas être importés dans le système, mais vous aurez toujours une copie électronique pour vos dossiers. USC recommande sauvegardes quotidiennes (voir page 36).

NOTICE

USC recommends the use of a surge protection device with a minimum rating of 400 Joules for all automated main control panels.

AVIS

USC recommande l'utilisation d'un dispositif de protection contre les surtensions avec une cote minimale de 400 joules pour tous les principaux panneaux de contrôle automatisés.

GENERAL AUTOMATION

SECTION C1

HMI-Main Control Panel

This section explains the function of the touch screen controls that apply to all systems.

USC STARTUP SCREEN

This is the first screen the operator will see after the system receives power at the initial startup. After reading the User Acknowledgement statement, push the acknowledge button at the bottom of the popup window to close the screen. Then press anywhere on the Startup screen to advance to the Main screen. If you wish to review the acknowledgement information at a later time, press the About button in the lower right corner of the Utilities screen (see page 24). Press the Acknowledgement button on the bottom of the popup.

The main screens vary depending on the system being run. Please see specific sections for breakdown of the main screen button descriptions.

- Seed Wheel Treater main screen description on page 40.
- LIW Treater main screen description on page 54.
- Batch Hopper main screen description on page 69.
- Tri - Flo ® main screen description on page 80.



H-O-A (HAND-OFF-AUTO) SCREEN

Hand-Off-Auto controls are provided for most of the automated devices in the system, and are accessed on this screen.



! AVERTISSEMENT

These H-O-A buttons force the selected component to be energized (HAND), de-energized (OFF), or automatically energized by the normal logic sequence (AUTO). The HAND function will cause the component to operate independent of whatever else the system is trying to do automatically. These functions should not normally be used if the automated sequencing is active. **Be sure to understand the impact of energizing or de-energizing a component with the HAND/Off settings before using them. These commands are not a substitute for Lockout/Tagout procedures when working on or near this machine. Use proper lockout/tagout procedures to disable the equipment before servicing it.**

Ces boutons HOA forcent le composant sélectionné pour être excité (HAND), hors tension (OFF), ou automatiquement alimentés par la séquence logique normale (AUTO). La fonction de la main provoquera la composante de fonctionner indépendamment de tout ce que le système essaie de faire automatiquement. Ces fonctions ne devraient normalement pas être utilisés si le séquençage automatisé est actif. **Assurez-vous de comprendre l'impact de énergisant ou désexciter un composant avec la main / Off paramètres avant de les utiliser. Ces commandes ne sont pas un substitut pour les procédures de verrouillage / étiquetage lorsque vous travaillez sur ou près de cette machine. Utilisez les procédures appropriées de verrouillage / débranchement pour désactiver l'équipement avant de l'entretenir.**

These screens vary depending on the system being run. Please see specific sections for breakdown of the H-O-A button descriptions. (Example below)

- Seed Wheel Treater H-O-A description on page 44.
- LIW Treater H-O-A description on page 59.
- Batch Hopper H-O-A description on page 73.
- Tri - Flo ® H-O-A description on page 85.

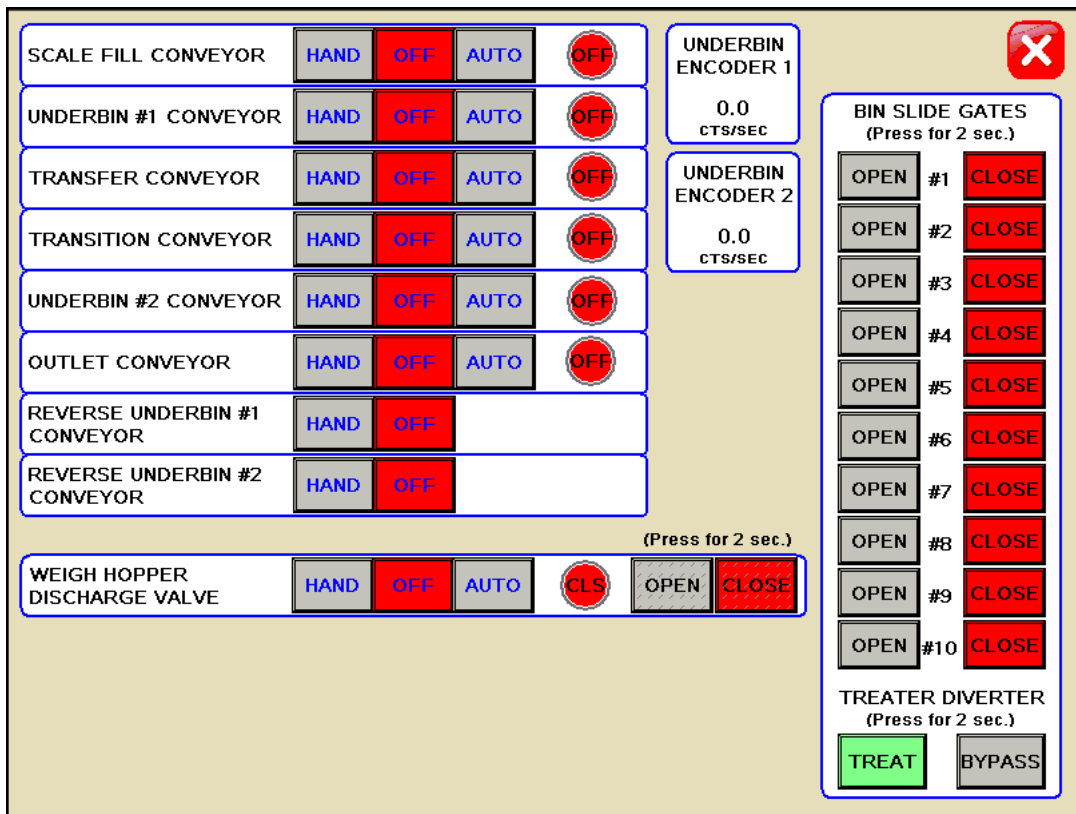

UTILITIES SCREEN

This screen allows the operator to set various system parameters and gives access to the Reports, editing various data, Security, Help Screens and General Information.

These screens vary depending on the type of system being run. Please see specific sections for breakdown of the Utilities Screen descriptions. (Example below)

- Seed Wheel Treater Utilities description on page 51.
- LIW Treater Utilities description on page 66.
- Batch Hopper Utilities description on page 78.
- Tri - Flo ® Utilities description on page 90.

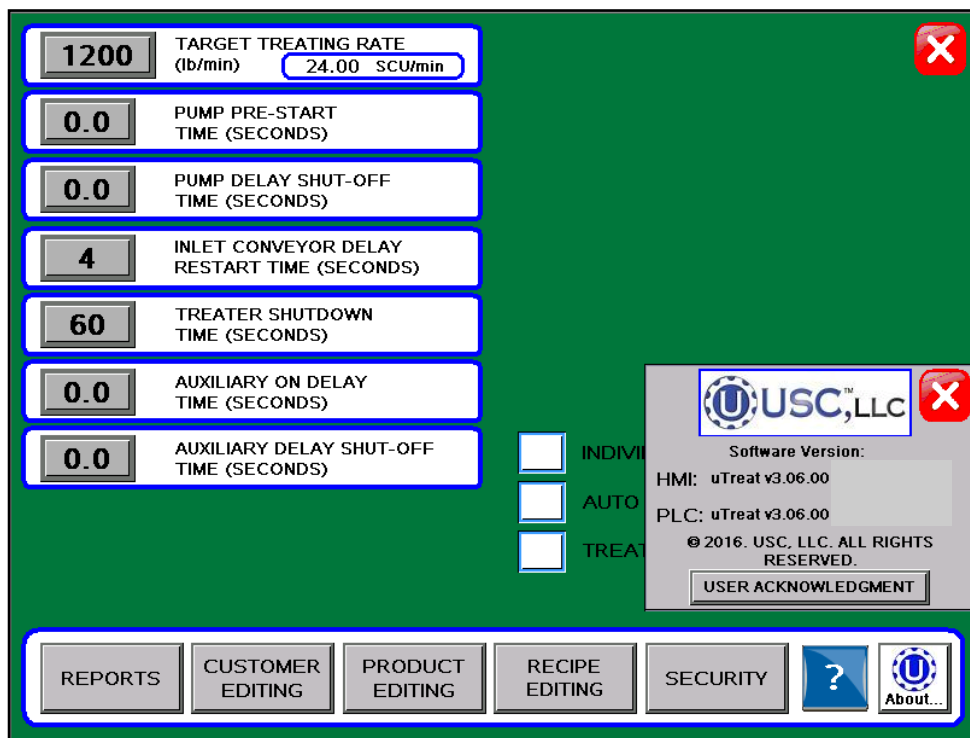

SECURITY SCREEN

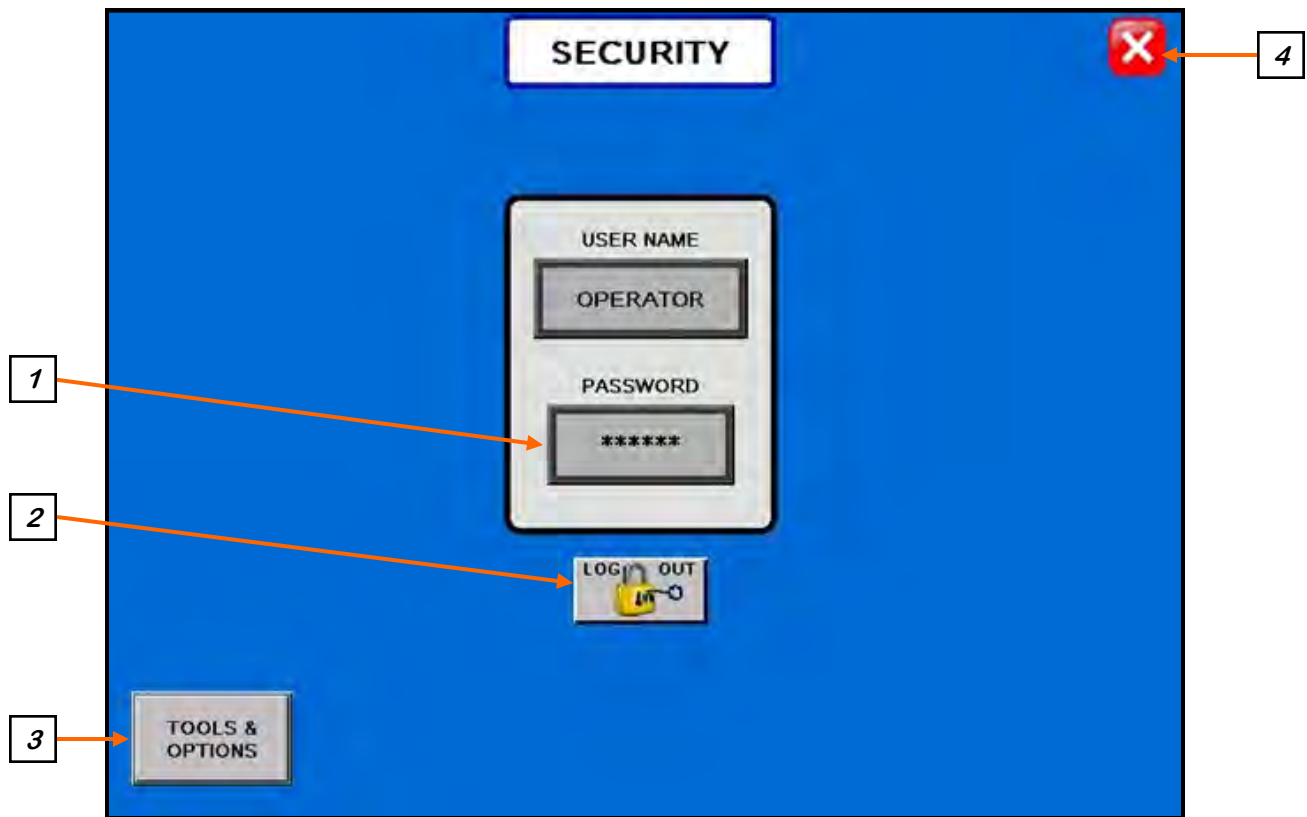

Security Screen Button Descriptions

1. PASSWORD ENTRY: The operator uses this input to obtain access to all options on this screen. When this button is pressed a keypad (below) will appear on the screen the password is **USC** and should only be made accessible to personnel qualified to operate the system. The User Name will stay OPERATOR.



Security Screen Button Descriptions (cont'd)

2. LOGOUT BUTTON: Pressing this button will log the operator out of the Security screen.

3. TOOLS & OPTIONS: Pressing this button will advance the operator to the Tools & Options screen.

4. SCREEN EXIT BUTTON: Pressing this button is used to exit back to the previous screen. Its functionality is the same throughout the HMI display.

TOOLS & OPTIONS SCREEN

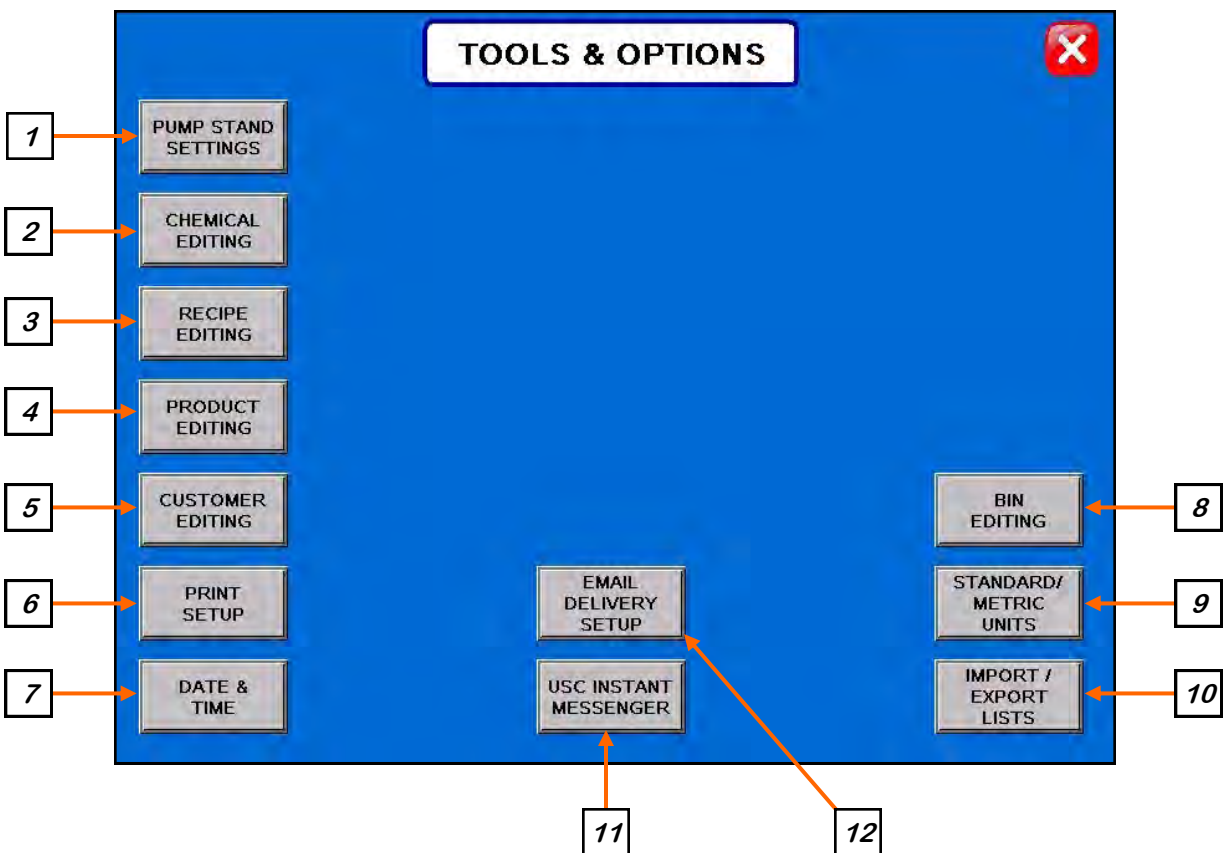

PUMP STAND SETTING SCREEN

1. PUMP STAND SETTINGS: Pressing this button will advance to the pump stand settings screen. The majority of the settings will be defined at system startup and may only be modified by someone with Admin Level 2 login privileges. From here the operator may select a pump stand from the list on the left. This brings up the current parameters for it on the right. From the editing section on the right, the operator may change the warning and alarm weight. Press the SAVE button, the button will stop blinking and the information will be saved. When the amount of chemical left reaches the pre-defined weight defined in the Warning Weight box, the message bar will appear at the top of the screen informing the operator that they will run out of treatment soon. When the amount of chemical left reaches the pre-defined weight defined in the Alarm Weight box, an alarm will sound and the run will be stopped automatically.

Pressing the Accuracy Tolerance button allows the operator enter a plus or minus tolerance by percentage for the pump to run in. A vertical line on the left side of the pump module on the main screen will indicate the tolerance status. If it is green, the pump flow rate is within tolerance. If it is red, it is out of tolerance.

The items in the yellow border in the lower right corner of the screen are for tracking the existing inventory in the mix tank, or tote container. To account for more liquid added to the mix tank or replacing a tote, press the Amount To Adjust Inventory button and a numeric keypad appears. Key in that amount of chemical to be added and press and hold the Plus button for 3 seconds. The Current Inventory indicator will update to show the amount added. After the inventory has been adjusted, the SAVE button will begin to flash. If you leave the screen without pressing it, the changes will not be saved. After a treating run has ended, the amount of chemical will automatically update the current inventory.

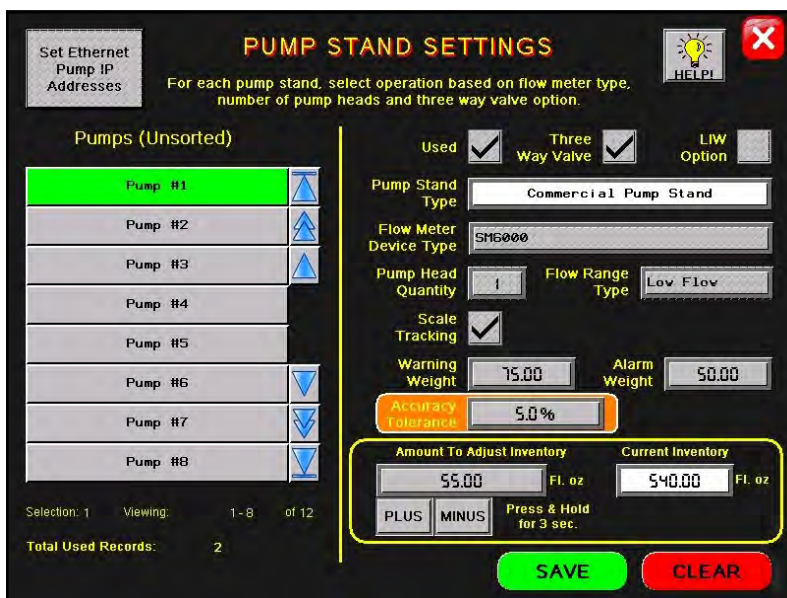

Tools & Options Screen Button Descriptions

2. CHEMICAL EDITING: Pressing this button will advance to the Chemical Editing screen where the operator may define the parameters for each individual chemical. Selecting a chemical from the list on the left brings up the current parameters for it on the right. To create a new chemical profile, select a used or unused box from the list, select the name box and key in a new name, then press the save button. If the operator wants the name to be the same as the barcode, press the name box and scan in the barcode. Press the barcode box and scan the barcode or enter it manually using the keypad. Next, enter the Target Rate, Chemical Calibration Factor and Measurement type. This screen also includes the Chemical Calibration Calculator button that will bring up a popup window (bottom). From this screen the operator may press the H-O-A SCREEN button at the bottom that brings up the treater H-O-A screen. From that screen, press the PUMP CALIBRATION button, this screen is where all chemical calculation rates are defined (see page 49). The operator must press SAVE or any changes made to the selected profile will be lost when leaving the screen.

The Density lb / gal and Chem Calb Factor Adj. buttons are only present when using a Loss-in-Weight pump stand. Density is required to properly define how much chemical is leaving the mix tank or tote. When the Chem Calb Factor Adj. is set to AUTO L-I-W it will automatically calibrate the pumps mid-run.

Tools & Options Screen Button Descriptions

3. RECIPE EDITING: Pressing this button will advance to the Recipe Editing screen where the operator defines the parameters for each Recipe. Selecting a Name from the list on the left brings up the current parameters for it on the right. To create a new recipe profile, select a used or unused box from the list, select the name box and key in a new name, then press the save button. If the operator wants the name to be the same as the barcode, press the name box and scan in the barcode. Press the barcode box and scan the barcode or enter it manually using the keypad. Activate the Auxiliary Control button if an auxiliary device is connected to the system. Also, what pumps will be active and the chemical for each pump. When the chemical box for each pump is selected, a drop down list will appear with all the chemicals already entered in the system. Choose a chemical from the list or scan in a barcode to select the chemical. If the bar code scanned in does not find a match, a popup will appear that reads NO MATCH FOUND. This indicates that it does not already exist in the system. It will need to be entered for the first time from the Chemical Editing screen. The Enable Recipe Control button in the upper left corner allows the operator to turn the recipe option ON or OFF. Press the SAVE button to file any changes made to the screen.

NOTE: When the Enable Recipe Controls button is in the ON position, the operator will be able to select a recipe from the startup screen before beginning a run. It may be selected but not modified from the startup screen. All changes must be made from the Recipe Editing screen.

RECIPE EDITING

Enable Recipe Controls: ON

Select the recipe you wish to rename and adjust the pump setting associated with it.

Recipe Profile List (Unsorted)

RECIPE 6	▲
RECIPE 7	▲
RECIPE 8	▲
RECIPE 9	
RECIPE 10	
RECIPE 11	▼
RECIPE 12	▼
RECIPE 13	▼

Selection: 6 Viewing: 6 - 13 of 20
Total Used Records: 13

Profile Editing

Barcode: Test Recipe 6

Name: RECIPE 6

Aux Control: OFF

Pump #1: CHEMICAL 3 AUTO

Pump #2: CHEMICAL 4 AUTO

Pump #3: CHEMICAL 5 AUTO

Pump #4: CHEMICAL 6 AUTO

PUMPS 1-4 PUMPS 5-8 PUMPS 9-12

SAVE CLEAR

Tools & Options Screen Button Descriptions

4. **PRODUCT EDITING: (Seed Wheel Treater)** Pressing this button will advance to the Product Editing screen. If you are looking for a specific product you may press the < ENTER SEARCH NAME > button and key in the name or use the arrows to scroll through the list. To create a new product profile, select a used or unused box from the list, select the name box and key in a new name, then press the save button. If the operator wants the name to be the same as the barcode, press the name box and scan in the barcode. Press the barcode box and scan the barcode or enter it manually using the keypad. Next, enter the Variety, Lot Number and Seeds per Unit of measurement. Press the Cup Weight button and enter the cup weight from the seed sample (see page 92). The Cups / Pocket ratio will be calculated by the system and displayed here.

You will also find the Seed Wheel Calibration Calculator button here that will advance the operator to the seed wheel calibration screen (bottom left). The operator may enter the actual scale weight, totalizer weight and then press APPLY. The system will update the cup pocket ratio based on this calculation. There is also a Calibrating Seed button on the top left of the Product Editing screen that when pressed will produce a popup (bottom right) for instructions on when to make multiple profiles for the same type of seed.

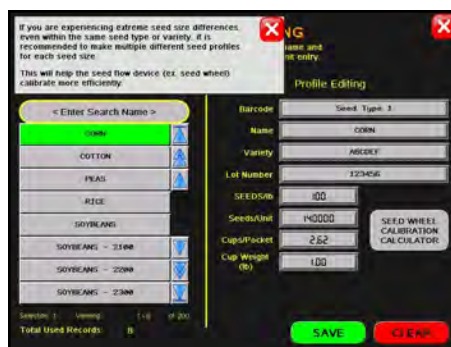
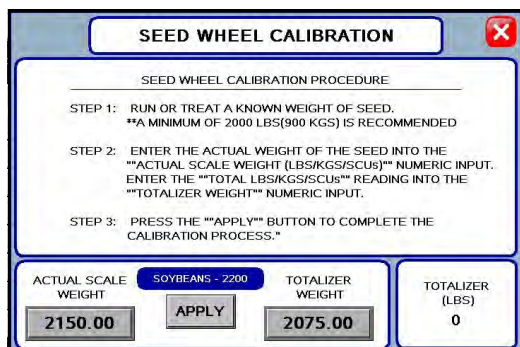

Tools & Options Screen Button Descriptions

4. PRODUCT EDITING: (LIW Treater) For Loss in Weight treaters, the product editing screen will appear with different settings. If you are looking for a specific customer you may press the < ENTER SEARCH NAME> button and key in the name or use the arrows to scroll through the list. To create a new product profile, select a used or unused box from the list, select the name box and key in a new name, then press the save button. If the operator wants the name to be the same as the barcode, press the name box and scan in the barcode. Press the barcode box and scan the barcode or enter it manually using the keypad. Next, enter the Variety, Lot Number, Seeds per pound and the maximum and minimum gate positions. When setting maximum and minimum gate positions. A popup will inform you as to what changing the setting will do to the system, you must then select OK to continue (bottom). If Set All Minimum Gate Positions is modified, the operator must press SAVE on the active profile to set the minimum for all profiles.

The Cal. Ratio is the calibration of the seed profile and the Cal. Speed indicator displays the last flow rate at which a calibration occurred. The Calibration Mode button is directly to the right of the Cal. Speed indicator. It has three modes of operation. The Auto Calibrate Ratio Continuous will automatically calibrate the Cal. Ratio during the entire run, the Auto Calibrate Ratio One-Shot will automatically calibrate the Cal. Ratio during the entire run one time, and the Auto Calibrate Ratio Off will not automatically calibrate the Cal. Ratio.

Press the Set All Auto Calibration States button and a popup will appear. From this screen you may confirm your choice or toggle to one of the other modes of operation before pressing OK.

The screenshot shows the 'PRODUCT EDITING' interface. On the left is a 'Product Profile List (Sorted)' with a search bar and a list of products including SOYBEANS - 2200 (highlighted in green). On the right is the 'Profile Editing' section with fields for Barcode, Name, Variety, Lot Number, SEEDS/lb, Seeds/Unit, Cal. Speed, Cal. Ratio, Max. Gate Pos., and Min. Gate Pos. Below these fields are buttons for 'Auto Calibrate Ratio Continuous', 'Set All Auto Calibration States', 'Set Maximum Gate Position', and 'Set All Minimum Gate Positions'. At the bottom are 'SAVE' and 'CLEAR' buttons. Three callout boxes provide details for the 'Set Auto Calibration State', 'Set Maximum Gate Position', and 'Set Minimum Gate Position' buttons.

Set Auto Calibration State
 Pressing this button will cause the auto calibration state setting on all profiles to be set to the entry below.
 Continue?
 OK [Auto Calibrate Ratio Continuous]

Set Maximum Gate Position
 Pressing this button will cause the acutator to open for several seconds.
 Continue?
 OK

Set Minimum Gate Position
 Pressing this button will cause the minimum gate position setting on all profiles to be set to the entry below.
 Continue?
 OK [3000]

Tools & Options Screen Button Descriptions

5. CUSTOMER EDITING: Pressing this button will advance to the Customer Editing screen. If you are looking for a specific customer you may press the < ENTER SEARCH NAME> button and key in the name or use the arrows to scroll through the list. To create a new customer profile, select a used or unused box from the list, select the name box and key in a new name, then press the save button. If the operator wants the name to be the same as the barcode, press the name box and scan in the barcode. Press the barcode box and scan the barcode or enter it manually using the keypad. After the new customers information has been entered press the SAVE button. If there is already a customer in the list that has the same name entered the SAVE button will be locked and you will be unable to save the entry. You must provide a unique name for each entry. If you enter a new customer and navigate away from that profile without hitting the SAVE button it will not be saved.



Tools & Options Screen Button Descriptions

6. PRINT SETUP: Pressing this button will advance to the print setup screen (top). This allows the operator to set up the company information which will be printed at the top of each report. The company information may be entered by selecting the blank space under each heading. The operator may also check the Auto Print boxes to print a report for a customer every time a report is generated as well as how many copies the customer requires.

7. DATE & TIME: Allows the operator to set the current date and time.

Tools & Options Screen Button Descriptions

8. BIN EDITING: Pressing this button will advance to the Bin Info screen.

This screen allows the operator to select a particular bin and enter a product profile for the seed that will be loaded into it. To create a new bin profile, select a used or unused box from the list, select the name box and key in a new name, then press the save button. Press the barcode box and scan the barcode or enter it manually using the keypad. The operator may also enter the product type by selecting the box and when the dropdown list appears, scan in the barcode from a label with the product information. If the bar code scanned in does not find a match, a popup will appear that reads NO MATCH FOUND, this indicates that it does not already exist in the system. It will need to be entered for the first time from the Product Editing screen. Select the bin from the Bin Profile list on the left side of the screen. Select the Product Type field and a drop down menu displays the seed types entered in the Product Edit screen.

On this page you will also find the Flow Rate and Travel Time. These indicators show the flow rate and travel time but unlike the indicators on the main screen, they are also active buttons allowing the operator to make a temporary adjustment to bring the run totals to the desired amount. Push the FLOW RATE button and increase or decrease the pounds per minute, then select the Gate Auto Calibration button and the system automatically adjusts the duration the bin slide gate stays open. The number of seconds needed to compensate is then displayed in the Gate Time Adj. field. The operator may also manually change these parameters.

The inventory of the bin may also be entered on this screen. Enter the amount of inventory that is to be added or subtracted into the Amount to Adjust Inventory box and then press and hold the “+” or the “-” box for 3 seconds. The total amount of inventory in the bin will be displayed to the right under current inventory. Make sure if you are adjusting by pounds the LBS button on the inventory side is green, or if entering by seed count units the SCU button is green so that the calculations are based on the measurement type. After entering all the information the SAVE button must be pressed for the bin site system to retain the information.

(Note: This button will not be present if the system is set up only to run a treater.)

Tools & Options Screen Button Descriptions

8. BIN EDITING (continued) : Help button.

"WHENEVER A BIN IS COMPLETELY EMPTIED AND THEN REFILLED, CHECK TO ENSURE THAT A PROPER FLOW RATE IS SAVED TO THE BIN'S INFORMATION.

THIS WILL HELP THE BIN RE-CALIBRATE A NEW FLOW RATE MORE EFFICIENTLY."

Gate Auto Calibration button

Displays the total inventory in the selected bin

Enter the amount of seed that is to be added or subtracted here.

Tools & Options Screen Button Descriptions

9. STANDARD/METRIC UNITS: Allows the operator to switch between Standard or Metric units of measurement. When this button is pressed a window will appear which will allow the operator to select the desired units of measurement.

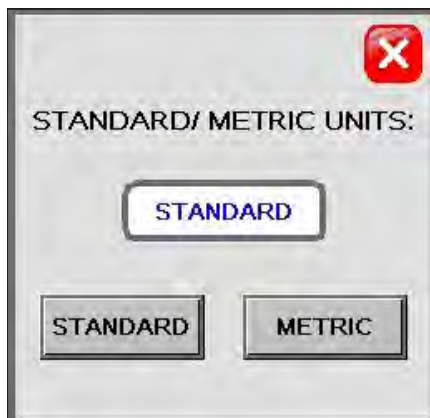

10. IMPORT / EXPORT LISTS: Pressing this button will advance to the Import / Export screen. From here you may choose from a variety of profiles and recipes that may be either imported from a flash drive, exported to a flash drive via the USB port located on the bottom of the main control panel. The flash drive must be in FAT32 format. Job Reports may be exported but not imported. After they are exported you may delete them from the system. After pushing the Export button, the message above it will be **Copying to USB...**, then it will change to indicate the number of files it is in the process of exporting. There will also be a warning above the module, **Please do not "Exit" or cycle power.** Exiting or shutting off the power will stop the process before it is complete. None of the buttons will function if you have not inserted a flash drive into the USB port.



Tools & Options Screen Button Descriptions

11. USC INSTANT MESSENGER: Pressing this button will advance to the Instant Messenger screen. This allows the operator to communicate with the technical support staff. This option only functions if the operator has U-Connect Pro connected to the control panel using a thin client to make the connection. U-Connect Pro comes standard with U-Treat v3.6.

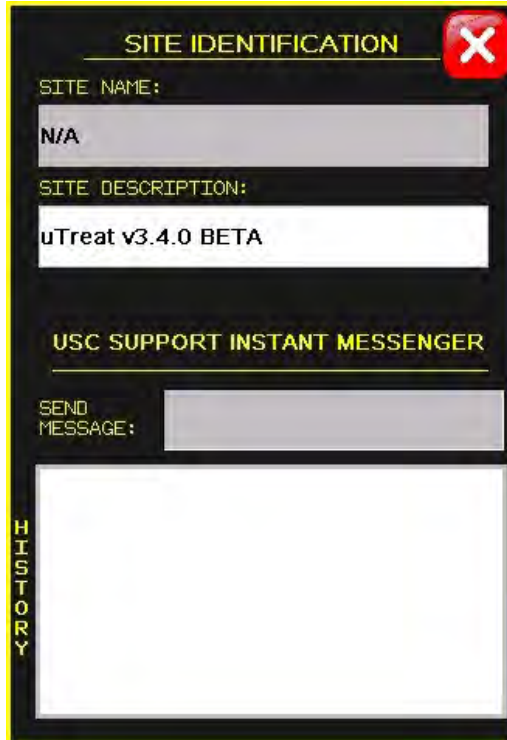

Tools & Options Screen Button Descriptions

12. EMAIL DELIVERY SETUP: Pressing this button will advance to the Email setup screen. This allows the operator to email reports and alarms through the U-Connect Pro if enabled. The individual reports will be sent in standard email format as text at the end of each run. When sending all reports, the email will be sent in a .CSV file for viewing in Excel format.

NOTICE

Before you can begin to set your e-mail parameters, you must first verify that the U-Connect-Pro thin client is attached to the system. Also, an individual with level 2 administrative login privileges has enabled the e-mailing option in the program and has entered the server settings.

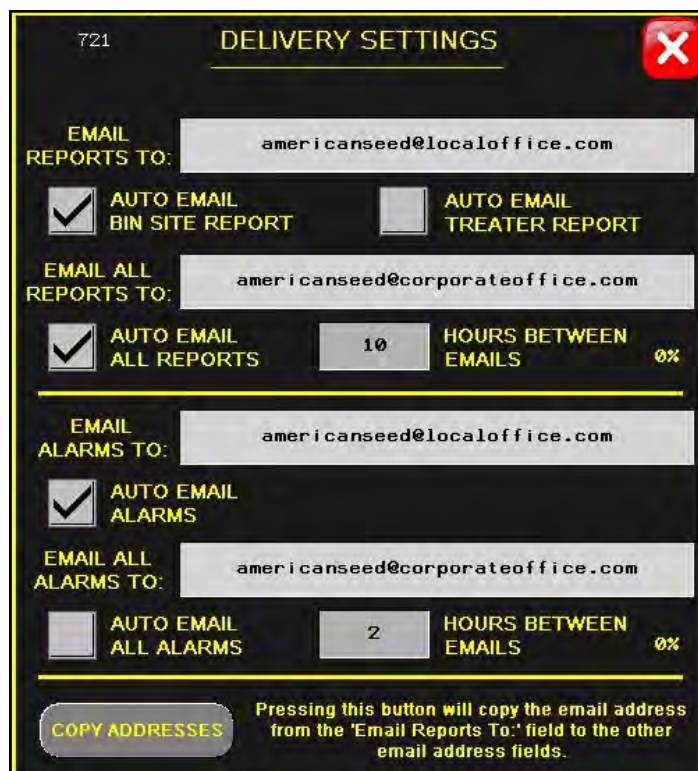

The following is a basic description of the information that needs to be entered in the DELIVERY SETTINGS screen .

EMAIL REPORTS TO: Enter the e-mail address to send the individual bin site and or treater reports at the end of each run.

AUTO EMAIL BIN SITE REPORT: Check this box to automatically send the bin site report at the end of each run.

Tools & Options Screen Button Descriptions

12. EMAIL DELIVERY SETUP (Continued):

AUTO EMAIL TREATER REPORT: Check this box to automatically send the treater report at the end of each run.

EMAIL ALL REPORTS TO: This is the address that the entire job reports CSV file will be sent to if the auto email all reports box has been checked.

AUTO EMAIL ALL REPORTS: Check this box to have all emails sent on a timed schedule.

HOURS BETWEEN EMAILS: Set the time interval in hours between the e-mailing of all reports.

EMAIL ALARMS TO: Enter the e-mail address to send the individual alarms to when they are requested.

AUTO EMAIL ALARMS: Check this box to automatically send an alarm to each time one occurs.

EMAIL ALL ALARMS TO: This is the address that the entire alarms CSV file will be sent to.

AUTO EMAIL ALL ALARMS: Check this box to have all emails sent on a timed schedule.

HOURS BETWEEN EMAILS: Set the time interval in hours between the e-mailing of all alarms.

SECTION
C-2

**LP, MP, LX, MX, LPX & LPV SEED
METERING WHEEL TREATER AUTOMATION**

MAIN SCREEN

This screen informs the operator of the status of all system motors and electrical devices. It also allows control / adjustment of system operations with a seed wheel.

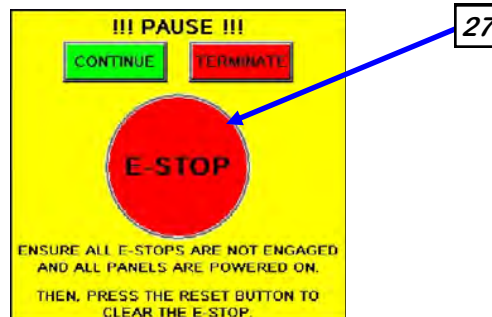
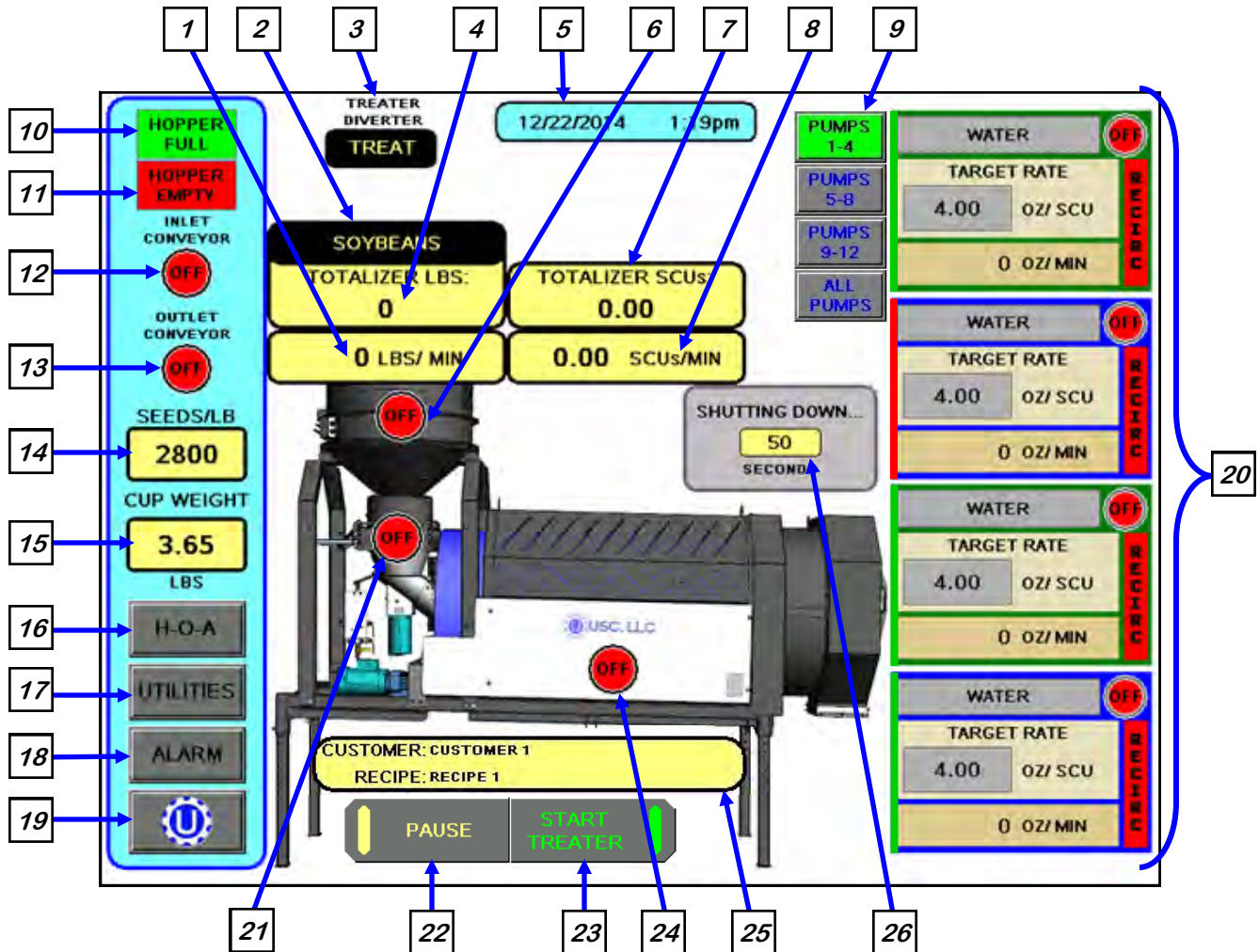

Main Screen Button Descriptions

- 1. SEED FLOW RATE:** Displays the seed flow rate in pounds or kilograms per minute.
- 2. SEED TYPE INDICATOR:** Displays seed type selected last.
- 3. DIVERTER INDICATOR (optional):** Informs the operator if the diverter is currently in the treat or bypass position. This indicator will only be present if the Treater has an automated bin site with a diverter.
- 4. TOTALIZED WEIGHT DISPLAY:** Displays the total pounds or kilograms of seed as they pass through the seed wheel.
- 5. CURRENT DATE AND TIME DISPLAY.**
- 6. SEED WHEEL MOTOR STATUS INDICATOR:** Informs the operator if the seed wheel is ON or OFF.
- 7. TOTALIZED SCU WEIGHT DISPLAY:** Displays the total Seed Count Units as it passes through the Seed Wheel. This is only visible if at least one of the pump stands has been set to run in the SCU mode or the SCU option is selected on the UTILITIES screen.
- 8. SCU SEED FLOW RATE:** Displays the seed flow rate in Seed Count Units per minute. This is only visible if at least one of the pump stands has been set to run in the SCU mode or the SCU option is selected on the UTILITIES screen.
- 9. PUMPS BUTTONS:** These buttons appear when more than 4 pumps are enabled. Use these buttons to rotate between each of the 3 groups of 4 pumps. Pressing the ALL PUMPS button will display all of the pump stand modules simultaneously.
- 10. HOPPER FULL:** Informs the operator when the proximity switch located in the supply hopper above the seed wheel is detecting seed. When the indicator is active any equipment plugged into the Inlet Conveyor plug will be turned off.
- 11. HOPPER EMPTY:** Informs the operator when the proximity switches located in the seed wheel are not detecting seed.
- 12. INLET CONVEYOR MOTOR STATUS INDICATOR:** Informs the operator if the inlet conveyor is ON or OFF.
- 13. OUTLET CONVEYOR MOTOR STATUS INDICATOR:** Informs the operator if the outlet conveyor is ON or OFF.
- 14. SEEDS / LB:** This shows the seeds per pound the operator entered for the selected seed profile used to calculate the seed flow rate. It will only appear if at least one of the pump stands has been set to run in the SCU mode or the SCU option is selected on the UTILITIES screen.

Main Screen Button Descriptions

15. CUP WEIGHT: This shows the seed cup weight that is used to calculate the seed flow rate the seed wheel will output. If the program is running a Bayer RH series treater, you must use the cup provided with that treater. It is a different size than the USC cup and is be measured in grams.

16. H-O-A (Hand-Off-Auto): This button advances the operator to the H-O-A screen (see page 44).

17. UTILITIES: This button advances the operator to the UTILITIES screen (see page 51).

18. ALARM: This button advances the operator to the ALARM screen to review, reset and delete alarms. The operator can also mute the alarm horn from this screen.

19. BIN SITE BUTTON: When the treater is being used in conjunction with a bin site this button allows the operator to toggle back and forth between the main treater screen and the main bin site screen. If only a Treater is in use, it returns the operator to the start up screen.

20. PUMP STATUS MODULES: This block of information informs the operator of the pump motor status ON or OFF, air actuated 3-way valve status, currently selected chemical, target flow rate and actual flow rate from flow meter. A vertical line on the left side of the pump module will indicate the tolerance status. If it is green, the pump flow rate is within tolerance. If it is red, it is out of tolerance.

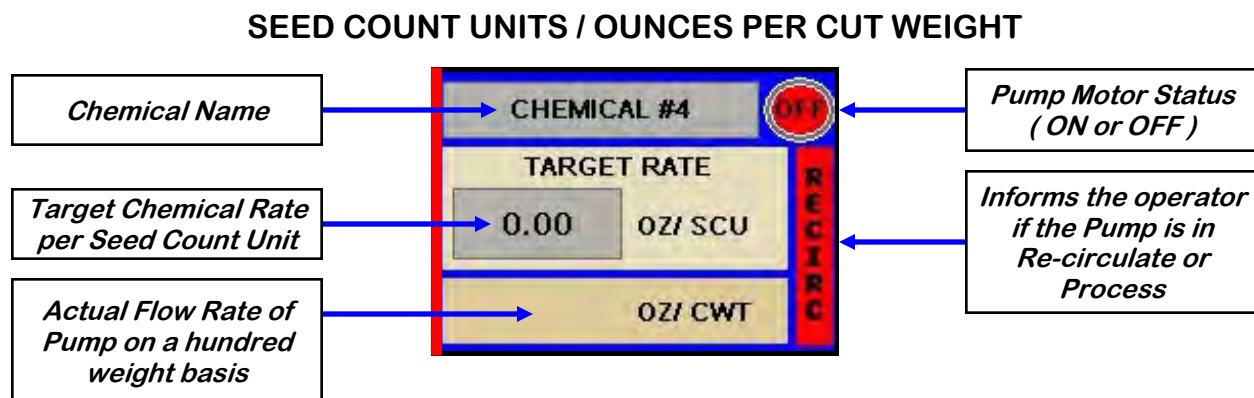
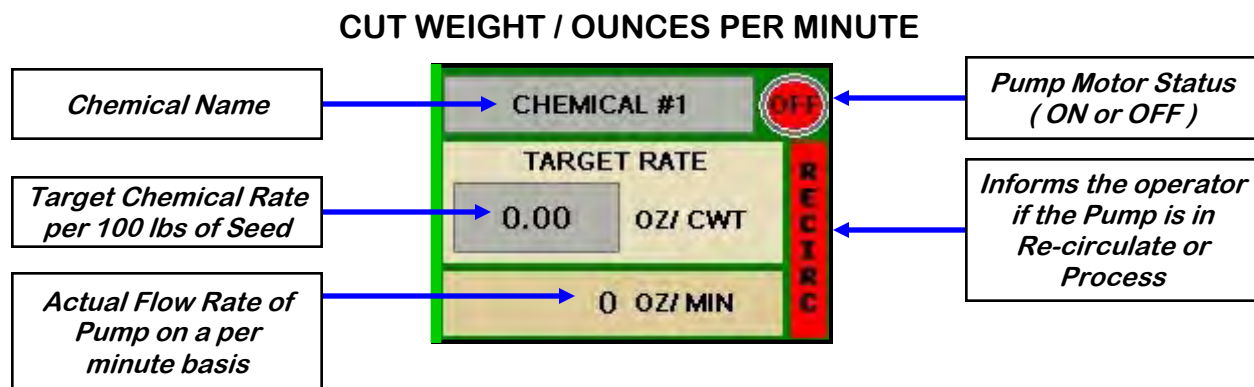

Main Screen Button Descriptions

NOTICE

AVIS

Actual flow rate of pump may be defined as either oz/min or oz/cwt regardless of the target rate setting (oz/cwt or oz/scu).

Débit réel de la pompe peut être définie comme étant soit oz / min ou oz / quintal indépendamment du réglage de taux cible (oz / ou de quintaux oz / SCU).

21. ATOMIZER MOTOR STATUS INDICATOR: Informs the operator if the atomizer motor is ON or OFF.

22. PAUSE BUTTON: Once the START button has been pushed and the system begins to operate, this becomes the PAUSE button.

23. START BUTTON: This is used to start the machine after all motors have been placed into the AUTO position. Once the button is pushed a pop-up window appears. You may select the customer by selecting the customer name box to search the rolodex for an existing entry by typing their name in the search field or using the navigation arrows. When all the information has been added press START to begin the run. Once the system begins to operate it becomes the SHUTDOWN button.

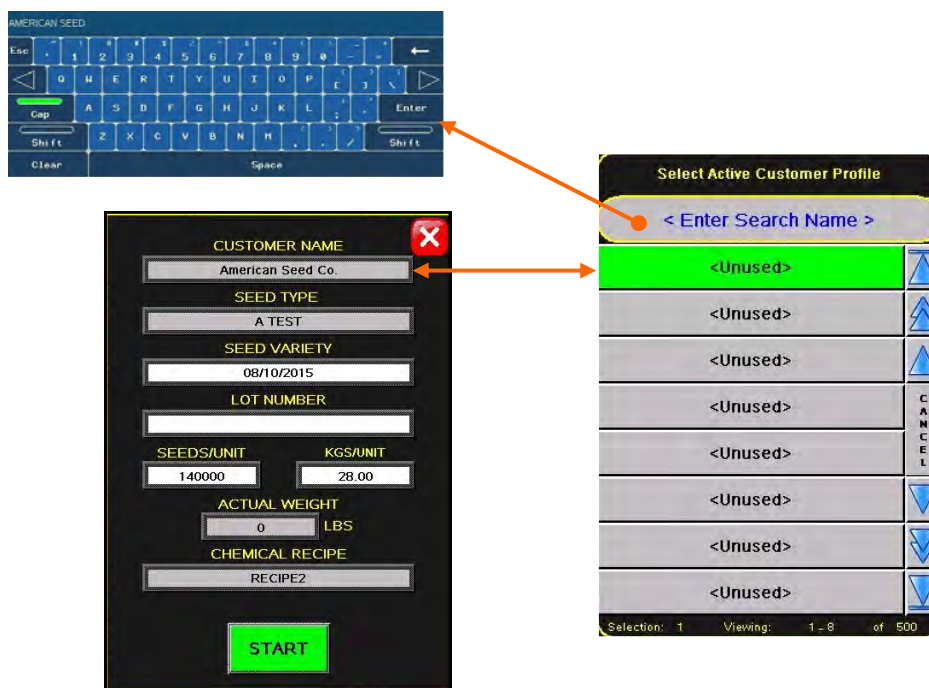

24. DRUM MOTOR STATUS INDICATOR: Informs the operator if the drum drive motor is ON or OFF.

25. CUSTOMER NAME DISPLAY: Displays the last customer selected and the current recipe in use.

Main Screen Button Descriptions

26. SYSTEM SHUTDOWN INDICATOR: Informs the operator that the system is in the process of shutting down. The timer in the middle counts down how many seconds are left before shutdown is complete.

27. EMERGENCY STOP INDICATOR: This blinking display is activated when the system's E-Stop button is activated.

TREATER H-O-A (HAND-OFF-AUTO) SCREEN

Hand-Off-Auto controls are provided for most of the automated devices in the system, and are accessed on this screen.



! AVERTISSEMENT

These H-O-A buttons force the selected component to be energized (HAND), de-energized (OFF), or automatically energized by the normal logic sequence (AUTO).

The HAND function will cause the component to operate independent of whatever else the system is trying to do automatically. These functions should not normally be used if the automated sequencing is active. **Be sure to understand the impact of energizing or de-energizing a component with the HAND/Off settings before using them. These commands are not a substitute for Lockout/Tagout procedures when working on or near this machine. Use proper lockout/tagout procedures to disable the equipment before servicing it.**

Ces boutons HOA forcent le composant sélectionné pour être excité (HAND), hors tension (OFF), ou automatiquement alimentés par la séquence logique normale (AUTO). La fonction de la main provoquera la composante de fonctionner indépendamment de tout ce que le système essaie de faire automatiquement. Ces fonctions ne devraient normalement pas être utilisés si le séquençage automatisé est actif. Assurez-vous de comprendre l'impact de énérgisant ou désexciter un composant avec la main / Off paramètres avant de les utiliser. Ces commandes ne sont pas un substitut pour les procédures de verrouillage / étiquetage lorsque vous travaillez sur ou près de cette machine. Utilisez les procédures appropriées de verrouillage / débranchement pour désactiver l'équipement avant de l'entretenir.

TREATER H-O-A (HAND-OFF-AUTO) SCREEN

Hand-Off-Auto controls are provided for most of the automated devices in the system, and are accessed on this screen.

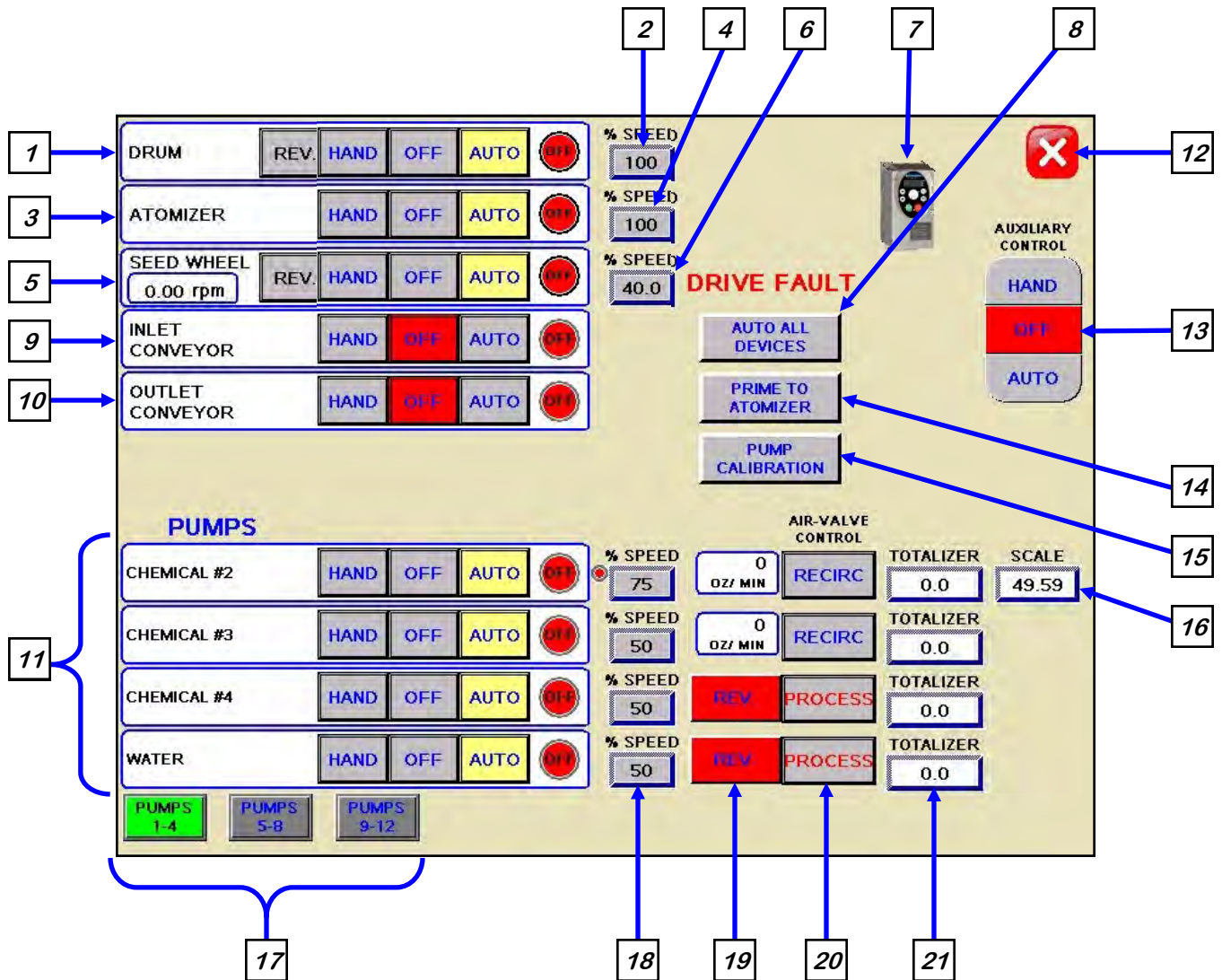

H-O-A Button Descriptions

1. DRUM CONTROL MODULE: This module controls the function of the drum. The HAND button will place the drum in the manual mode of operation. The OFF button will turn the associated device in the OFF mode of operation. The AUTO button will place the device in the automatic mode of operation. The motor will not operate in this function unless all other needed devices are in the AUTO mode and the START button is pressed on the main screen. The reverse button will only be present when running a Bayer RH series treater.

2. DRUM PERCENT SPEED: When this button is pressed, a numeric touch pad (bottom) will appear to allow the operator to manually adjust the speed of the drum.

3. ATOMIZER CONTROL MODULE: This module controls the function of the atomizer. The HAND button will place the atomizer in the manual mode of operation. The OFF button will turn the associated device in the OFF mode of operation. The AUTO button will place the device in the automatic mode of operation. The motor will not operate in this function unless all other needed devices are in the AUTO mode and either the PRIME TO ATOMIZER or the START button is pressed on the main screen.

4. ATOMIZER PERCENT SPEED: When this button is pressed, a numeric touch pad (bottom) will appear to allow the operator to manually adjust the speed of the atomizer.

5. SEED WHEEL CONTROL MODULE:

This module controls the function of the seed wheel. The HAND button will place the seed wheel in the manual mode of operation. This module shows the current RPM of the seed wheel (right). The OFF button will turn the associated device in the OFF mode of operation. The AUTO button will place the device in the automatic mode of operation. The motor will not operate in this function unless all other needed devices are in the AUTO mode and the START button is pressed on the main screen. The reverse button will only be present when running a Bayer RH series treater.

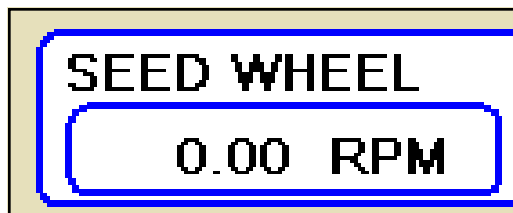

6. SEED WHEEL PERCENT SPEED: When this button is pressed, a numeric touch pad (right) will appear to allow the operator to manually adjust the speed of the seed wheel. When running in the AUTO mode the program will override this setting.

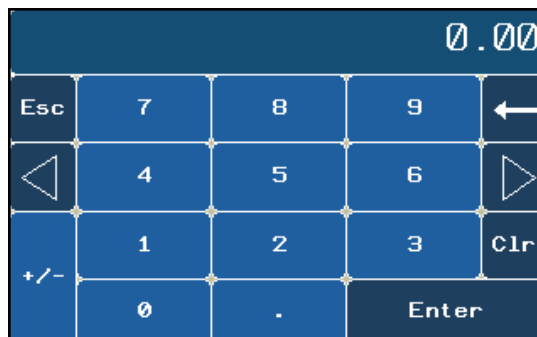

H-O-A Button Descriptions

7. VFD FAULT RESET BUTTON: When a VFD fault occurs, a popup screen will display indicating which drive failed along with a message indicating the problem. After the problem has been resolved, press the reset button to resume operation.

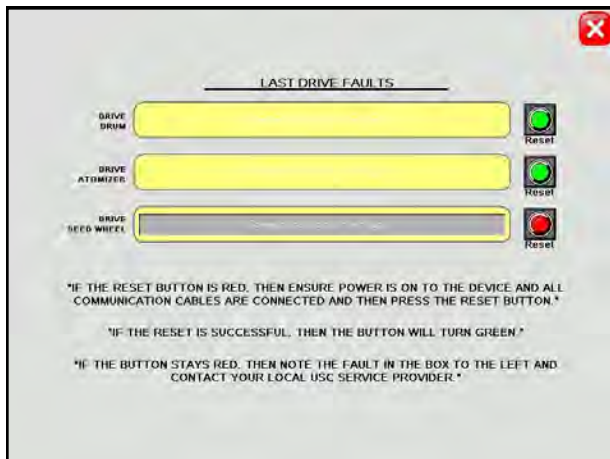

8. AUTO ALL DEVICES BUTTON: When this button is pushed, it globally changes all treater HOA settings to the AUTO mode of operation. If the treater is operating with a bin site, this button will not change anything on the bin site HOA screen.

9. INLET CONVEYOR CONTROL MODULE: This module controls the function of the inlet conveyor. The HAND button will place the inlet conveyor in the manual mode of operation. The OFF button will turn the associated device in the OFF mode of operation. The AUTO button will place the device in the automatic mode of operation. The motor will not operate in this function unless all other needed devices are in the AUTO mode and the START button is pressed on the main screen. When the proximity switch located in the supply hopper above the seed wheel is detecting seed and the indicator is active, any equipment plugged into the Inlet Conveyor plug will be turned off.

10. OUTLET CONVEYOR CONTROL MODULE: This module controls the function of the outlet conveyor. The HAND button will place the outlet conveyor in the manual mode of operation. The OFF button will turn the associated device in the OFF mode of operation. The AUTO button will place the device in the automatic mode of operation. The motor will not operate in this function unless all other needed devices are in the AUTO mode and the START button is pressed on the main screen.

NOTICE

If the system is running with a bin site, the inlet and outlet conveyors will be controlled by outlet path configuration defined by the system administrator. If this is enabled, the conveyors OFF mode will change to AUTO. This only applies if the bin site is enabled. The HAND mode is not affected.

H-O-A Button Descriptions

11. PUMP CONTROL MODULES: These modules control the function of the Pump Stands. The HAND button will place the desired pump in the manual mode of operation. The OFF button will turn the associated device in the OFF mode of operation. The AUTO button will place the device in the automatic mode of operation. The pump will not operate in this function until the START button is pressed on the main screen. This module also monitors the proximity sensor in the Seed Wheel. When the proximity switch is detecting seed and the indicator is active, the 3 - way valve will switch to PROCESS. When no seed is detected it will switch to RECIRC.

12. SCREEN EXIT BUTTON: This button is used to exit back to the previous screen. Its functionality is the same throughout the HMI display.

13. AUXILIARY CONTROL: This module allows the operator to control any unit which is plugged into the auxiliary port located on the bottom of the treater control panel. The HAND button will allow the user to operate the unit in the manual mode of operation. The OFF button will disconnect control to the auxiliary port. The AUTO button will place the unit in the automatic mode of operation. Any unit plugged into the auxiliary port will not operate in this function until the START button is pressed on the main screen. It will also turn off using the same logic as the pump stands.

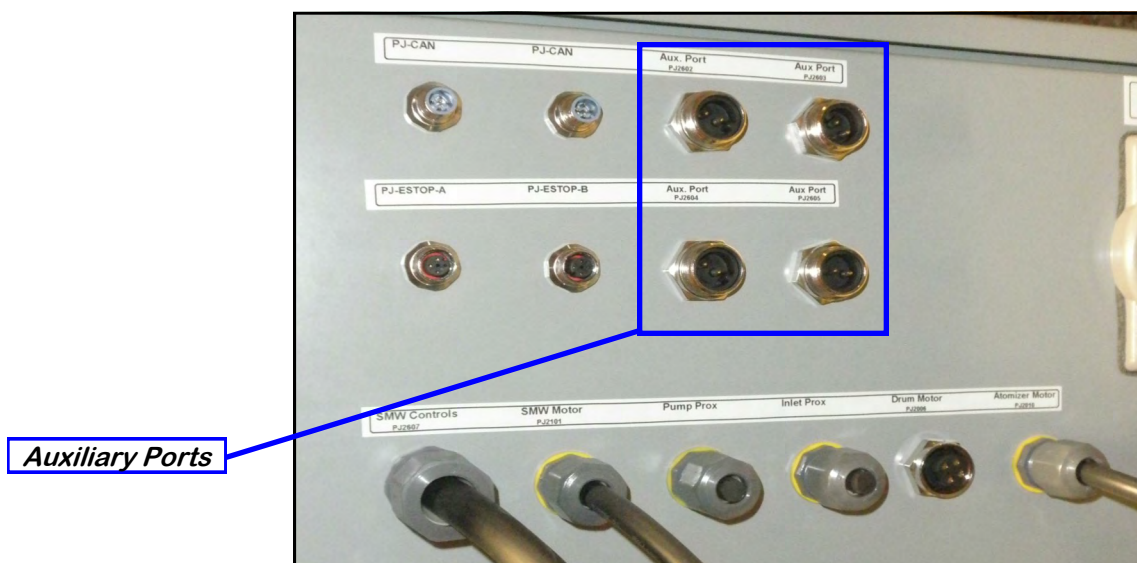

14. PRIME TO ATOMIZER BUTTON: Used before a controlled startup to preload chemical in the tubing leading to the atomizer. To operate this button, place the atomizer and any pump that will be used in the AUTO mode. Next press and hold the PRIME TO ATOMIZER button. The atomizer and pumps will turn on and the liquid will be directed to the atomizer. The atomizer and pumps will run as long as the button is being pressed. When the button is released the atomizer and pumps will shut-off.

H-O-A Button Descriptions

15. PUMP CALIBRATION BUTTON: Pressing this button brings up the screen below. This screen is used to calibrate the pump stand. Enter the number of the pump you wish to calibrate and a target run time for the calibration. The longer the run time the more accurate the calibration. USC recommends a minimum of 60 seconds. Pressing the JOG PUMP MOTOR button will turn the pumps on and off for short periods of time to fill the process lines attached to the top of the calibration tube. Press the button again to stop the flow. Press the START button to begin the calibration. When the target run time has elapsed, the pump will shutoff automatically. If for any reason you need to stop the process, press the STOP button. If the calibration is stopped before the target time has elapsed, the operator must start the process over again. If you press start and continue from your stopping point, the calibration will not be accurate. Enter the totalizer reading and the calibration tube reading in the TOTALS section. Press the UPDATE RATIO button to correct the calibration ratio. For Loss-in-Weight pump stands, this section would be updating the Density. Closing this popup will stop the calibration process if it has not been completed.

16. SCALE INDICATOR: This indicates the weight of the chemical detected from the scale head on pump stands that are equipped with a scale.

17. PUMPS BUTTONS: These buttons appear when more than 4 pumps are enabled. Use these buttons to rotate between each of the 3 groups of 4 pumps.

PUMP CALIBRATION CALCULATOR

Pump # to Adjust:
 Selected Pump's Chemical Name:

Target Run Time (Seconds):
 Actual Rate (mL / min):

Target Rate (mL / min):

Rough Est. Total (mL):

TOTALS:

Cal. Tube Total mL

Calculated Totalizer mL

Elapsed Run Time (Seconds): seconds

CALIBRATION RATIO:

Current Ratio:

Calculated Ratio:

H-O-A Button Descriptions

18. PUMP PERCENT SPEED: When this button is pressed, a numeric touch pad will appear to allow the operator to manually adjust the speed of the pump(s). When running in the AUTO mode the program will override this setting.

19. REVERSE BUTTON: Allows the operator to reverse the pump direction and pump the product back into the mix tank. When the pump is in Hand or Auto mode, this button will become a display for the actual pump flow rate. When running in the AUTO mode the program will override this setting.

20. AIR VALVE CONTROL MODULE: This module controls where liquid is diverted for each pump. When a desired pump is placed in the HAND mode, the RECIRC button will appear next to that pump control module. In this mode, liquid is pumped out of its desired tank, through the air actuated 3-way valve manifold and back into the mix tank. When the RECIRC. button is pressed, the icon will change to PROCESS. In this mode, liquid is diverted from the air actuated 3-way valve, to the atomizer. When the OFF button is pressed the pump will go back to RECIRC. When the pump is placed in the AUTO mode the Air Valve Control cannot be accessed. (Optional feature)

21. TOTALIZER INDICATOR: Displays in real time the amount of chemical that has been applied. If the pump is set in the HAND mode, pushing the button will reset it to zero.

TREATER UTILITIES SCREEN

This screen allows the operator to set various system parameters and gives access to the Reports, Product Selection, Security, Alarms, Customer Information and General Information screens.

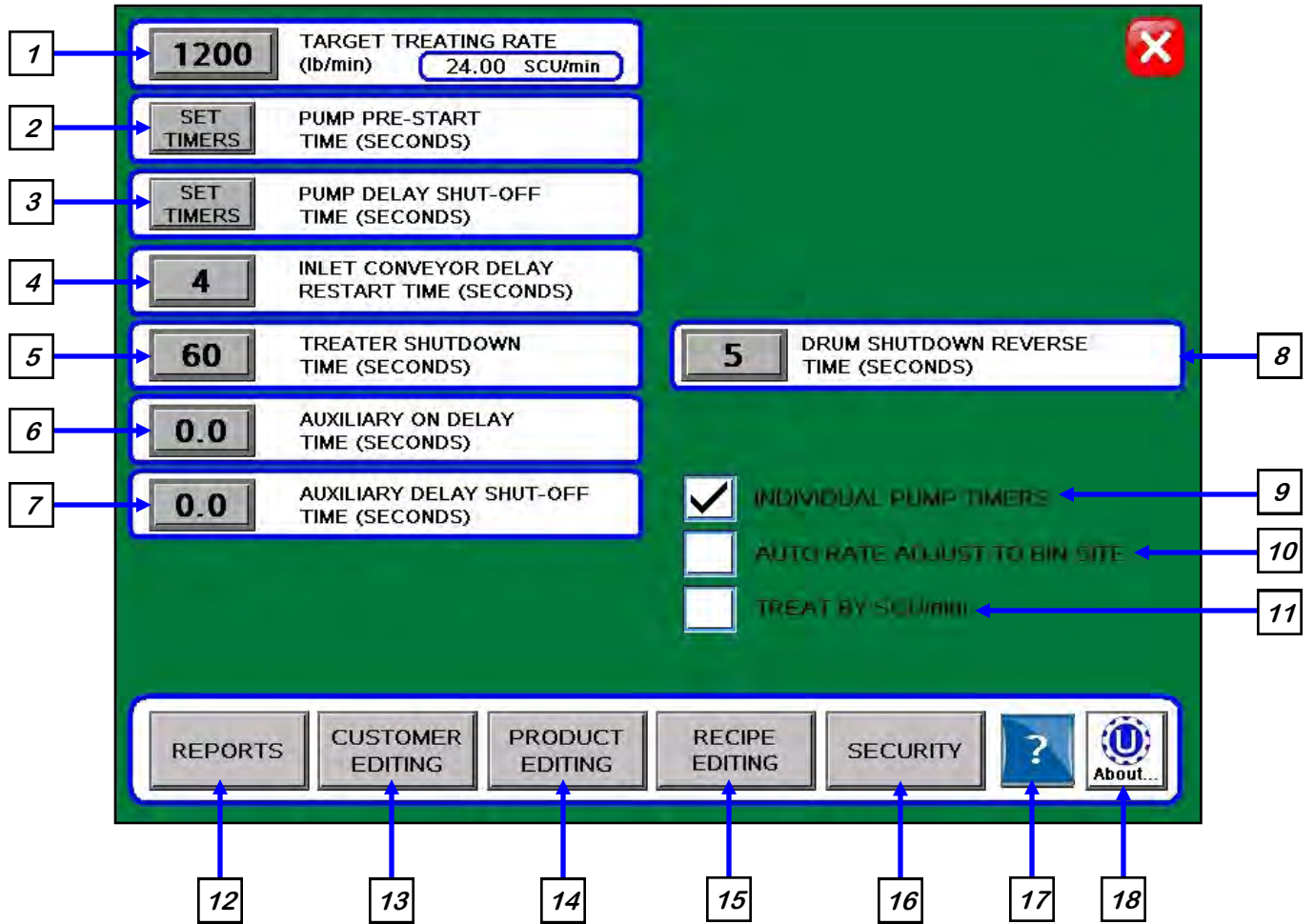

NOTICE When buttons 1-7 are pressed, a numeric touch pad (right) will appear allowing the operator to enter in a number for that particular parameter.

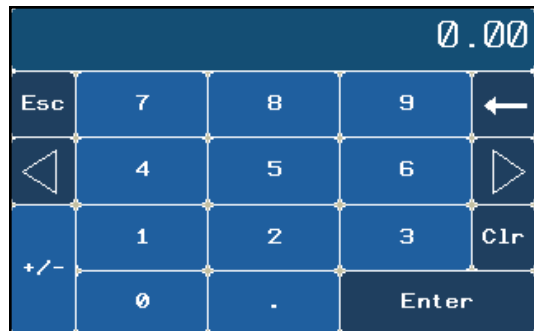

Utilities Screen Button Descriptions

1. TARGET TREATING RATE: Pressing this button allows the operator to adjust the estimated treating rate in pounds per minute. This number is used by the system to control the rate of the seed wheel and pumps.

2. PUMP PRE-START TIME: Pressing this button allows the operator to adjust the start time of the pumps based on the proximity sensor in the seed wheel detecting seed and the timing of the seed wheel turning on. This number will allow the air actuated 3-way valve to actuate and begin sending liquid to the seed treater a pre-defined number of seconds before the seed wheel will turn on. This will help prevent any untreated seed at the beginning of a run.

3. PUMP DELAY SHUT-OFF TIME: Pressing this button allows the operator to adjust the delay shut-off time of the pumps after the proximity switches located in the seed wheel do not detect anymore seed.

4. INLET CONVEYOR DELAY RESTART TIME: Pressing this button allows the operator to adjust the restart time of the inlet conveyor after the proximity switch located at the top of the inlet hopper above the seed wheel no longer detects seed.

5. TREATER SHUTDOWN TIME: Pressing this button allows the operator to adjust the delay shutdown time of the seed treater after the SHUTDOWN button has been pressed after a run. This time will allow the seed treater and any conveyors to completely clean out.

6. AUXILIARY ON DELAY TIME: Pressing this button allows the operator to adjust the delay from the time the proximity sensor in the seed wheel detects seed to the time a signal is sent to an auxiliary device connected to the system to start it.

7. AUXILIARY DELAY SHUTOFF TIME: Pressing this button allows the operator to adjust the delay from the time the proximity sensor in the seed wheel no longer detects seed to the time a signal is sent to an auxiliary device connected to the system to stop it.

8. DRUM SHUTDOWN REVERSE TIME (SECONDS): This button will only be present when running a Bayer RH series treater. Pressing this button allows the operator to adjust the time from the drum beginning to run in reverse until it shuts down.

9. INDIVIDUAL PUMP TIMERS: When this box is not checked, the pump pre-set time and pump delay shut-off time buttons will display a number. Pressing these buttons brings up a numeric keypad to set the times for all pump stands globally from this screen. When the box is checked, these buttons toggle to Set Timers. Pressing these buttons will then activate a popup window that has a button for each individual pump stand allowing the operator to set different pre-start and delay times for each pump (see page 53).

Utilities Screen Button Descriptions

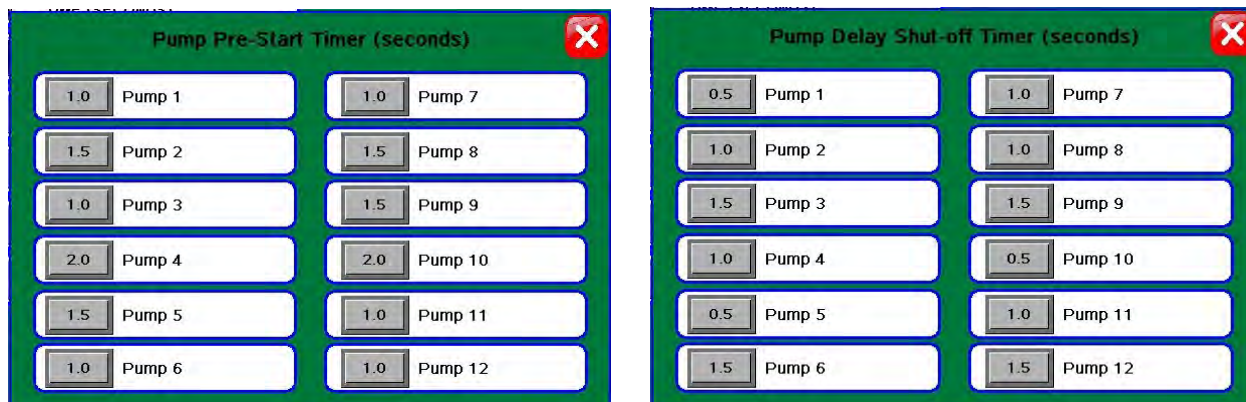

10. AUTO RATE ADJUST TO BIN SITE: (Only present when treater is used with a Tri - Flo ® and USC Bin Site Automation). When this box is checked, Target Treating Rate will automatically be adjusted to 2% slower than the bin site.

11. TREAT BY SCU / MIN: When this box is checked, the primary Target Treating Rate will be calculated in Seed Count Units per minute. Unchecked, it will be calculated in pounds per minute.

12. REPORTS: This button advances the operator to the Reports screen (see page 94).

13. CUSTOMER EDITING: This button advances the operator to the Customer Editing screen (see page 32).

14. PRODUCT EDITING: This button advances the operator to the Product Editing screen (see page 30).

15. RECIPE EDITING: This button advances the operator to the Recipe Editing screen (see page 29).

16. SECURITY: This button advances the operator to the Security screen (see page 25).

17. INFORMATION: This button advances the operator to the information screen where the operator can find vital information on storage and troubleshooting.

18. ABOUT USC: Pressing this button brings up a popup screen showing the operator what software release is installed.

SECTION C-3

LPV LIW TREATER AUTOMATION

MAIN SCREEN

This screen informs the operator of the status of all system motors and electrical devices and allows for control/adjustment of system operations.

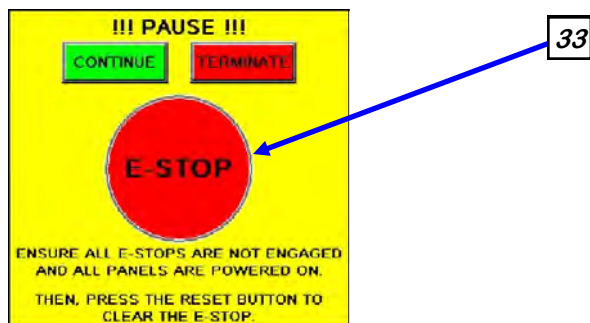
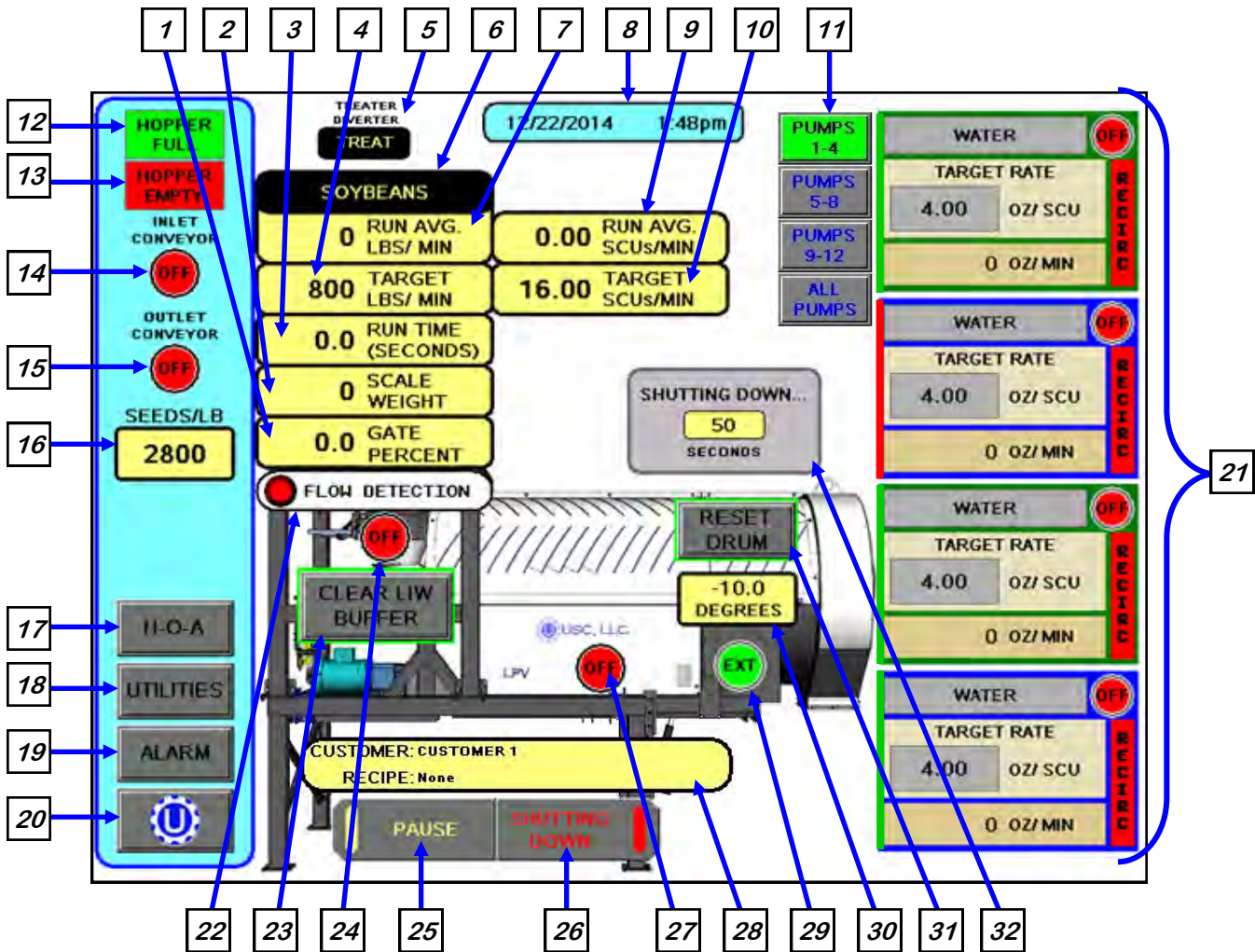

Main Screen Button Descriptions

1. GATE PERCENT: Displays how far open the actuator gate is in a percentage.

2. SCALE WEIGHT: Displays the current weight of the scale for the LIW module.

3. RUN TIME: Displays how long seed flow has been occurring through the atomizer chamber. Increments whenever the seed proximity sensor sees seed and the LIW actuator is open during an automated run.

4. TARGET/CURRENT FLOW RATE BUTTON: Button that switches between the current and target flow rate by weight per minute.

5. DIVERTER INDICATOR (optional): Informs the operator if the diverter is currently in the treat or bypass position. This indicator will only be present if the Treater has an automated bin site with a diverter.

6. SEED TYPE INDICATOR: Displays seed type selected last.

7. RUN AVERAGE DISPLAY: Displays the current runs average weight per minute.

8. CURRENT DATE AND TIME DISPLAY.

9. RUN AVERAGE DISPLAY: Displays the current runs average SCUs per minute. This is only visible if at least one of the pump stands has been set to run in the SCU mode or the SCU option is selected on the UTILITIES screen.

10. TARGET/CURRENT FLOW RATE: Displays the target/current flow rate by SCUs. This is only visible if at least one of the pump stands has been set to run in the SCU mode or the SCU option is selected on the UTILITIES screen.

11. PUMPS BUTTONS: These buttons appear when more than 4 pumps are enabled. Use these buttons to rotate between each of the 3 groups of 4 pumps. Pressing the ALL PUMPS button will display all of the pump stand modules simultaneously.

12. HOPPER FULL: Informs the operator when the proximity switch located in the supply hopper above the seed metering device is detecting seed. When the indicator is active any equipment plugged into the Inlet Conveyor plug will be turned off.

13. HOPPER EMPTY: Informs the operator when the seed metering device is not detecting seed.

14. INLET CONVEYOR MOTOR STATUS INDICATOR: Informs the operator if the inlet conveyor is ON or OFF.

15. OUTLET CONVEYOR MOTOR STATUS INDICATOR: Informs the operator if the outlet conveyor is ON or OFF.

16. SEEDS/LB: This shows the seeds per pound the operator entered for the selected seed profile used to calculate the seed flow rate. It will only appear if at least one of the pump stands has been set to run in the SCU mode or the SCU option is selected on the UTILITIES screen.

Main Screen Button Descriptions

17. H-O-A (Hand-Off-Auto): This button advances the operator to the H-O-A screen (see page 59).

18. UTILITIES: This button advances the operator to the UTILITIES screen (see page 66).

19. ALARM: This button advances the operator to the ALARM screen to review, reset and delete alarms. The operator can also mute the alarm horn from this screen.

20. BIN SITE BUTTON: When the treater is being used in conjunction with a bin site this button allows the operator to toggle back and forth between the main treater screen and the main bin site screen. If only a Treater is in use, it returns the operator to the start up screen.

21. PUMP STATUS MODULES: This block of information informs the operator of the pump motor status ON or OFF, air actuated 3-way valve status, currently selected chemical, target flow rate and actual flow rate from flow meter. A vertical line on the left side of the pump module will indicate the tolerance status. If it is green, the pump flow rate is within tolerance. If it is red, it is out of tolerance.

CUT WEIGHT / OUNCES PER MINUTE



SEED COUNT UNITS / OUNCES PER CUT WEIGHT



Main Screen Button Descriptions

NOTICE

AVIS

Actual flow rate of pump may be defined as either oz/min or oz/cwt regardless of the target rate setting (oz/cwt or oz/scu).

Débit réel de la pompe peut être définie comme étant soit oz / min ou oz / quintal indépendamment du réglage de taux cible (oz / ou de quintaux oz / SCU).

22. FLOW DETECTION INDICATOR: Informs the operator as to when the scale has seen enough weight fluctuation to assume that the seed is either being removed or added to the scale

23. CLEAR LIW BUFFER BUTTON: This button is only visible during a run of seed when the scale weight is below the weight threshold for actuator adjustment and the prox sees seed but the LIW actuator is not open. This allows the operator to clean out the buffer area of the LIW system between the scale and the actuator gate.

24. ATOMIZER MOTOR STATUS INDICATOR: Informs the operator if the atomizer motor is ON or OFF.

25. PAUSE BUTTON: Once the START button has been pushed and the system begins to operate, this becomes the PAUSE button.

26. START /STOP BUTTON: This is used to start the machine after all motors have been placed into the AUTO position. Once the button is pushed a pop-up window appears. You may select the customer by selecting the customer name box to search the rolodex for an existing entry by typing their name in the search field or using the navigation arrows. When all the information has been added press START to begin the run. Once the system begins to operate it becomes the SHUTDOWN button.

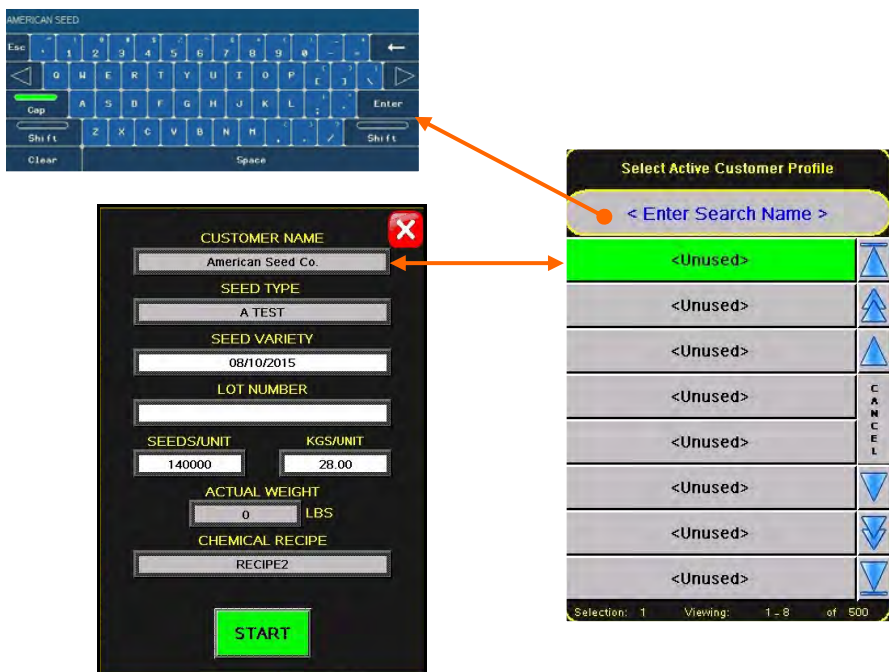

Main Screen Button Descriptions

27. DRUM MOTOR STATUS INDICATOR: Informs the operator if the drum drive motor is ON or OFF.

28. CUSTOMER NAME DISPLAY: Displays the last customer selected and the current recipe in use.

29. DRUM TILT INDICATOR: Informs the operator whether the drum is extended or retracted. This is only visible when the drum tilt option is enabled.

30. DRUM TILT DEGREES DISPLAY: Informs the operator how many degrees the drum is extended or retracted.

31. RESET DRUM BUTTON: This button allows the operator to reset the drum to the start position. This is only visible when the drum tilt option is enabled and the system is in an active run of seed but the prox sensor is not seeing seed long enough to allow the LIW actuator to have closed. Example: in between boxes of seed.

32. SYSTEM SHUTDOWN INDICATOR: Informs the operator that the system is in the process of shutting down. The timer in the middle counts down how many seconds are left before shutdown is complete.

33. EMERGENCY STOP INDICATOR: This blinking display is activated when the system's E-Stop button is activated.

TREATER H-O-A (HAND-OFF-AUTO) SCREEN

Hand-Off-Auto controls are provided for most of the automated devices in the system, and are accessed on this screen.



! AVERTISSEMENT

These H-O-A buttons force the selected component to be energized (HAND), de-energized (OFF), or automatically energized by the normal logic sequence (AUTO). The HAND function will cause the component to operate independent of whatever else the system is trying to do automatically. These functions should not normally be used if the automated sequencing is active. **Be sure to understand the impact of energizing or de-energizing a component with the HAND/Off settings before using them. These commands are not a substitute for Lockout/Tagout procedures when working on or near this machine. Use proper lockout/tagout procedures to disable the equipment before servicing it.**

Ces boutons HOA forcent le composant sélectionné pour être excité (HAND), hors tension (OFF), ou automatiquement alimentés par la séquence logique normale (AUTO). La fonction de la main provoquera la composante de fonctionner indépendamment de tout ce que le système essaie de faire automatiquement. Ces fonctions ne devraient normalement pas être utilisés si le séquençage automatisé est actif. Assurez-vous de comprendre l'impact de énérgisant ou désexciter un composant avec la main / Off paramètres avant de les utiliser. Ces commandes ne sont pas un substitut pour les procédures de verrouillage / étiquetage lorsque vous travaillez sur ou près de cette machine. Utilisez les procédures appropriées de verrouillage / débranchement pour désactiver l'équipement avant de l'entretenir.

TREATER H-O-A (HAND-OFF-AUTO) SCREEN

Hand-Off-Auto controls are provided for most of the automated devices in the system, and are accessed on this screen.

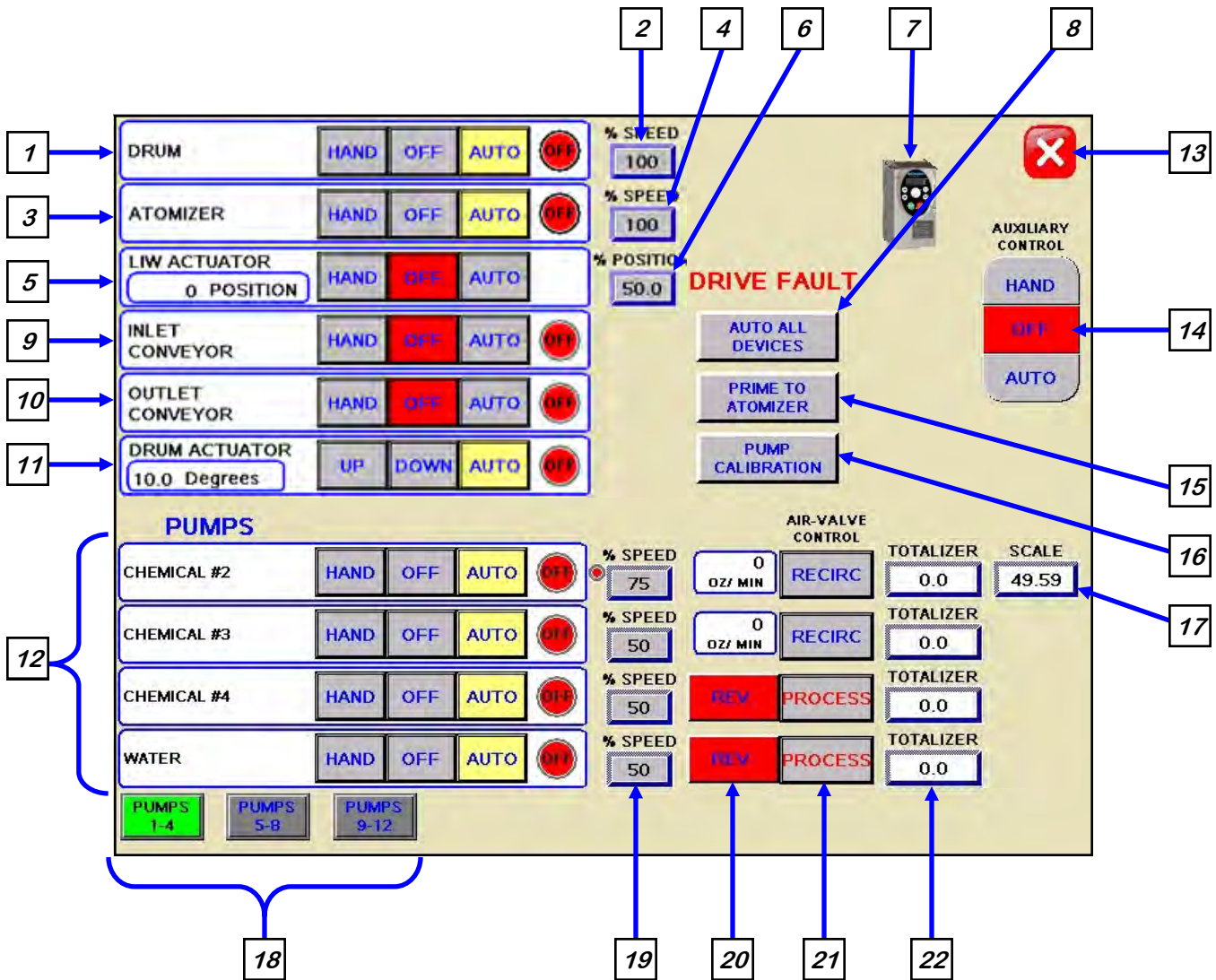

H-O-A Button Descriptions

1. DRUM CONTROL MODULE: This module controls the function of the drum. The HAND button will place the drum in the manual mode of operation. The OFF button will turn the associated device in the OFF mode of operation. The AUTO button will place the device in the automatic mode of operation. The motor will not operate in this function unless all other needed devices are in the AUTO mode and the START button is pressed on the main screen.

2. DRUM PERCENT SPEED: When this button is pressed, a numeric touch pad (bottom) will appear to allow the operator to manually adjust the speed of the drum.

3. ATOMIZER CONTROL MODULE: This module controls the function of the atomizer. The HAND button will place the atomizer in the manual mode of operation. The OFF button will turn the associated device in the OFF mode of operation. The AUTO button will place the device in the automatic mode of operation. The motor will not operate in this function unless all other needed devices are in the AUTO mode and either the PRIME TO ATOMIZER or the START button is pressed on the main screen.

4. ATOMIZER PERCENT SPEED: When this button is pressed, a numeric touch pad (bottom) will appear to allow the operator to manually adjust the speed of the atomizer.

5. LIW ACTUATOR CONTROL MODULE: This module controls the function of the loss in weight actuator gate. The HAND button will open the gate to the selected percentage of maximum open position. The OFF button will turn the device off and reset the gate to the minimum gate position. The AUTO button will place the device in the automatic mode of operation. The actuator will not operate in this function unless all other needed devices are in the AUTO mode and the START button is pressed on the main screen.

6. LIW ACTUATOR PERCENT POSITION: When this button is pressed, a numeric touch pad (right) will appear to allow the operator to manually adjust the percentage of the actuator gate. When running in the AUTO mode the program will override this manual setting.

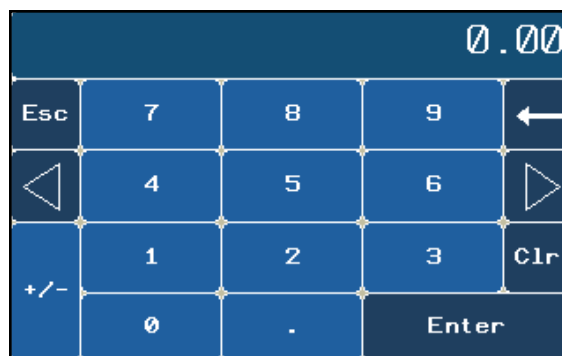

7. VFD FAULT RESET BUTTON: When a VFD fault occurs, a popup screen will display indicating which drive failed along with a message indicating the problem. After the problem has been resolved, press the reset button to resume operation. See top of page 62.

H-O-A Button Descriptions

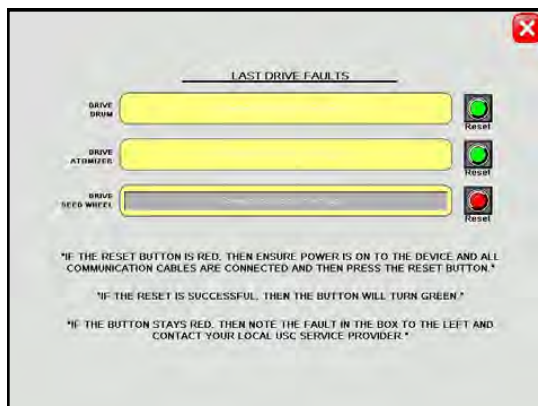

8. AUTO ALL DEVICES BUTTON: When this button is pushed, it globally changes all treater HOA settings to the AUTO mode of operation. If the treater is operating with a bin site, this button will not change anything on the bin site HOA screen.

9. INLET CONVEYOR CONTROL MODULE: This module controls the function of the inlet conveyor. The HAND button will place the inlet conveyor in the manual mode of operation. The OFF button will turn the associated device in the OFF mode of operation. The AUTO button will place the device in the automatic mode of operation. The motor will not operate in this function unless all other needed devices are in the AUTO mode and the START button is pressed on the main screen. When the proximity switch located in the supply hopper above the seed metering device is detecting seed and the indicator is active, any equipment plugged into the Inlet Conveyor plug will be turned off.

10. OUTLET CONVEYOR CONTROL MODULE: This module controls the function of the outlet conveyor. The HAND button will place the outlet conveyor in the manual mode of operation. The OFF button will turn the associated device in the OFF mode of operation. The AUTO button will place the device in the automatic mode of operation. The motor will not operate in this function unless all other needed devices are in the AUTO mode and the START button is pressed on the main screen.

NOTICE

If the system is running with a bin site, the inlet and outlet conveyors will be controlled by outlet path configuration defined by the system administrator. If this is enabled, the conveyors OFF mode will change to AUTO. This only applies if the bin site is enabled. The HAND mode is not affected.

AVIS

Si le système fonctionne avec un site bin, les entrée et de sortie des convoyeurs seront contrôlés par la configuration du trajet de sortie défini par l'administrateur système. Si cette option est activée, le mode convoyeurs OFF va changer à AUTO. Ce ne vaut que si le site bin est activée. Le mode HAND est pas affectée.

H-O-A Button Descriptions

11. DRUM ACTUATOR MODULE: This module controls the drum tilt actuator. The UP button raises the drum when held. The DOWN button lowers the drum when held. The AUTO button will place the device in the automatic mode of operation. The actuator will not operate in this function unless all other needed devices are in the AUTO mode and the START button is pressed on the main screen.

12. PUMP CONTROL MODULES: These modules control the function of the Pump Stands. The HAND button will place the desired pump in the manual mode of operation. The OFF button will turn the associated device in the OFF mode of operation. The AUTO button will place the device in the automatic mode of operation. The pump will not operate in this function until the START button is pressed on the main screen. This module also monitors the proximity sensor in the Seed Metering device. When the proximity switch is detecting seed and the indicator is active, the 3 - way valve will switch to PROCESS. When no seed is detected it will switch to RECIRC.

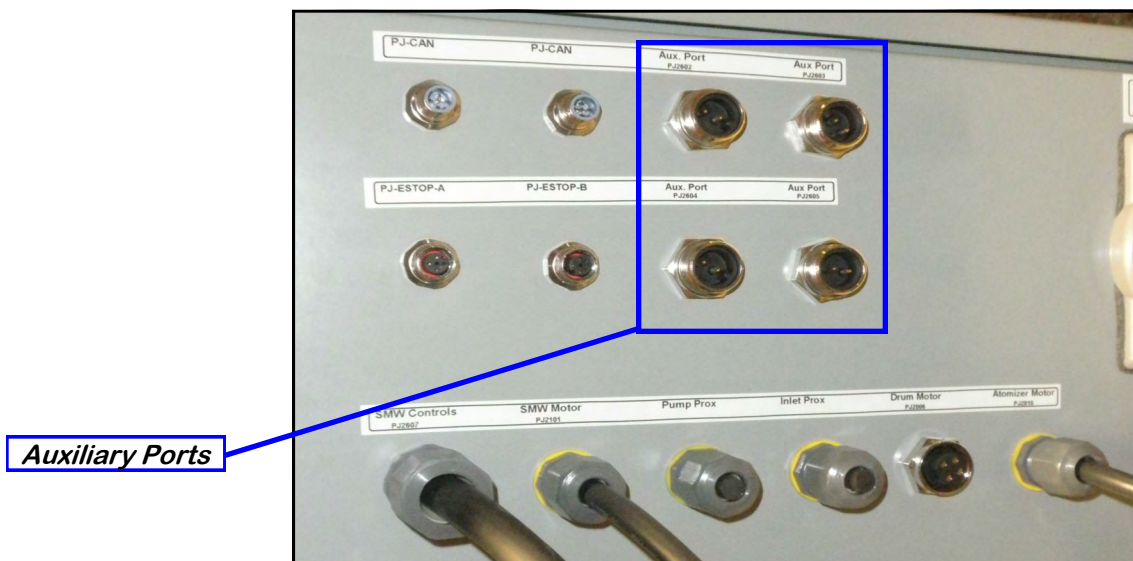

13. SCREEN EXIT BUTTON: This button is used to exit back to the previous screen. Its functionality is the same throughout the HMI display.

14. AUXILIARY CONTROL: This module allows the operator to control any unit which is plugged into the auxiliary port located on the bottom of the treater control panel. The HAND button will allow the user to operate the unit in the manual mode of operation. The OFF button will disconnect control to the auxiliary port. The AUTO button will place the unit in the automatic mode of operation. Any unit plugged into the auxiliary port will not operate in this function until the START button is pressed on the main screen. It will also turn off using the same logic as the pump stands. See picture (above).

H-O-A Button Descriptions

15. PRIME TO ATOMIZER BUTTON: Used before a controlled startup to preload chemical in the tubing leading to the atomizer. To operate this button, place the atomizer and any pump that will be used in the AUTO mode. Next press and hold the PRIME TO ATOMIZER button. The atomizer and pumps will turn on and the liquid will be directed to the atomizer. The atomizer and pumps will run as long as the button is being pressed. When the button is released the atomizer and pumps will shut-off.

16. PUMP CALIBRATION BUTTON: Pressing this button brings up the screen below. This screen is used to calibrate the pump stand. Enter the number of the pump you wish to calibrate and a target run time for the calibration. The longer the run time the more accurate the calibration. USC recommends a minimum of 60 seconds. Pressing the JOG PUMP MOTOR button will turn the pumps on and off for short periods of time to fill the process lines attached to the top of the calibration tube. Press the button again to stop the flow. Press the START button to begin the calibration. When the target run time has elapsed, the pump will shutoff automatically. If for any reason you need to stop the process, press the STOP button. If the calibration is stopped before the target time has elapsed, the operator must start the process over again. If you press start and continue from your stopping point, the calibration will not be accurate. Enter the totalizer reading and the calibration tube reading in the TOTALS section. Press the UPDATE DENSITY button to correct the ratio. For standard pump stands, this section would be updating the Calibration ratio. Closing this popup will stop the calibration process if it has not been completed.

PUMP CALIBRATION CALCULATOR

HELP!

Pump # to Adjust: Selected Pump's Chemical Name:

Target Run Time (Seconds): Actual Rate (oz/min):

Target Rate (oz/min): **JOG PUMP MOTOR**

Rough Est. Total (FL. oz): **START** **STOP**

TOTALS

Cal. Tube Total FL. oz

Calculated Totalizer FL. oz

Elapsed Run Time (Seconds): seconds

DENSITY

Calibration Ratio:

Current Density (lb / gal):

Calculated Density (lb / gal):

UPDATE DENSITY

H-O-A Button Descriptions

17. SCALE INDICATOR: This indicates the weight of the chemical detected from the scale head on pump stands that are equipped with a scale.

18. PUMPS BUTTONS: These buttons appear when more than 4 pumps are enabled. Use these buttons to rotate between each of the 3 groups of 4 pumps.

19. PUMP PERCENT SPEED: When this button is pressed, a numeric touch pad will appear to allow the operator to manually adjust the speed of the pump(s). When running in the AUTO mode the program will override this setting.

20. REVERSE BUTTON: Allows the operator to reverse the pump direction and pump the product back into the mix tank. When the pump is in Hand or Auto mode, this button will become a display for the actual pump flow rate. When running in the AUTO mode the program will override this setting.

21. AIR VALVE CONTROL MODULE: This module controls where liquid is diverted for each pump. When a desired pump is placed in the HAND mode, the RECIRC button will appear next to that pump control module. In this mode, liquid is pumped out of its desired tank, through the air actuated 3-way valve manifold and back into the mix tank. When the RECIRC. button is pressed, the icon will change to PROCESS. In this mode, liquid is diverted from the air actuated 3-way valve, to the atomizer. When the OFF button is pressed the pump will go back to RECIRC. When the pump is placed in the AUTO mode the Air Valve Control cannot be accessed. (Optional feature)

22. TOTALIZER INDICATOR: Displays in real time the amount of chemical that has been applied. If the pump is set in the HAND mode, pushing the button will reset it to zero.

TREATER UTILITIES SCREEN

This screen allows the operator to set various system parameters and gives access to the Reports, Product Selection, Security, Alarms, Customer Information and General Information screens.

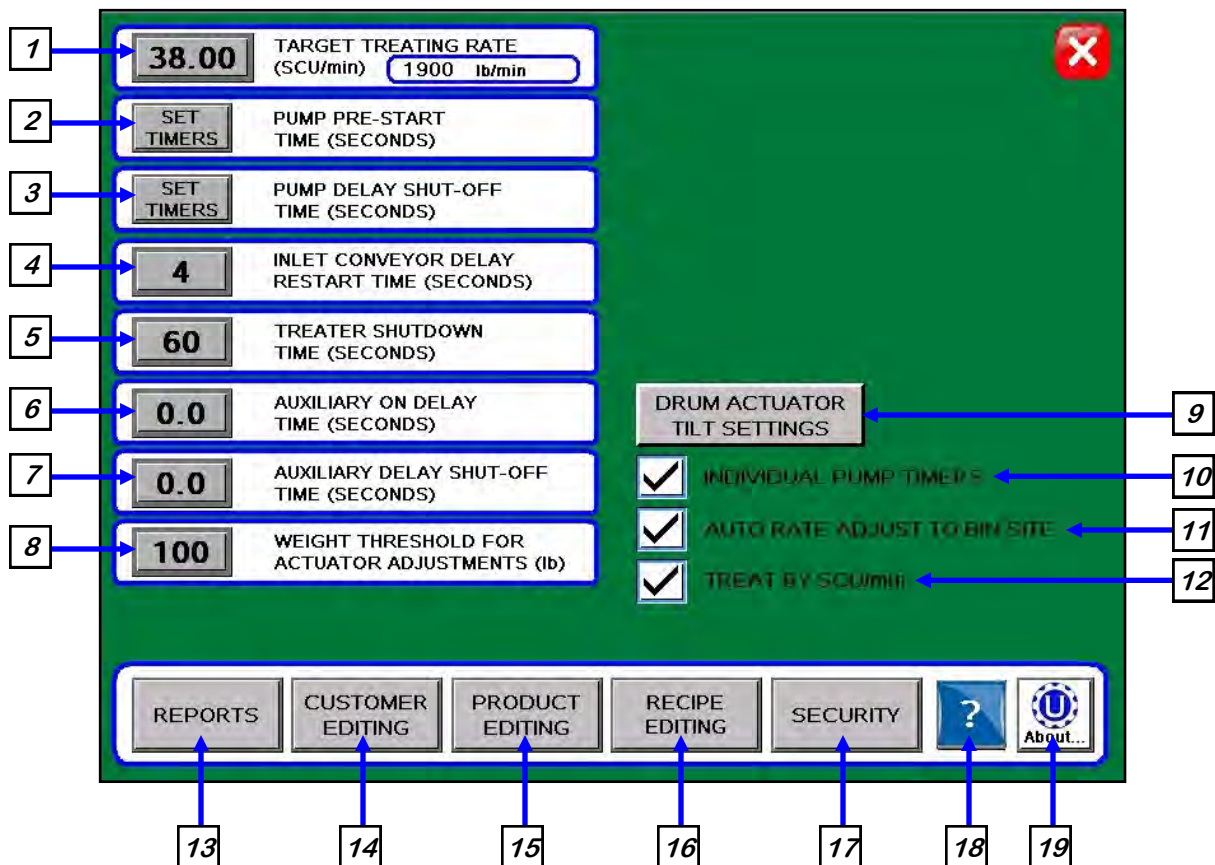

NOTICE

When buttons 1-8 are pressed, a numeric touch pad (right) will appear allowing the operator to enter in a number for that particular parameter.

AVIS

Lorsque les boutons sont pressés 1-8, un pavé tactile numérique (à droite) se affiche permettant à l'opérateur d'entrer dans un certain nombre de ce paramètre particulier.

1. TARGET TREATING RATE: Pressing this button allows the operator to adjust the estimated treating rate in pounds per minute. This number is used by the system to control the rate of the actuator gate and pumps.

2. PUMP PRE-START TIME: Pressing this button allows the operator to adjust the start time of the pumps based on the detection of seed in the metering device. This number will allow the air actuated 3-way valve to actuate and begin sending liquid to the seed treater a predefined number of seconds before the seed actuator gate will open. This will help prevent any untreated seed at the beginning of a run.

Utilities Screen Button Descriptions

3. PUMP DELAY SHUT-OFF TIME: Pressing this button allows the operator to adjust the delay shut-off time of the pumps after the proximity switches located in the seed metering device no longer detects seed.

4. INLET CONVEYOR DELAY RESTART TIME: Pressing this button allows the operator to adjust the restart time of the inlet conveyor after the proximity switch located at the top of the inlet hopper above the seed metering device no longer detects seed.

5. TREATER SHUTDOWN TIME: Pressing this button allows the operator to adjust the delay shutdown time of the seed treater after the SHUTDOWN button has been pressed after a run. This time will allow the seed treater and any conveyors to completely clean out.

6. AUXILIARY ON DELAY TIME: Pressing this button allows the operator to adjust the delay from the time the proximity sensor in the hopper cone detects seed to the time a signal is sent to an auxiliary device connected to the system to start it.

7. AUXILIARY DELAY SHUTOFF TIME: Pressing this button allows the operator to adjust the delay from the time the proximity sensor in the hopper cone no longer detects seed to the time a signal is sent to an auxiliary device connected to the system to stop it.

8. WEIGHT THRESHOLD FOR ACTUATOR ADJUSTMENTS: Pressing this button allows the operator to adjust the weight required to stop the flow rate adjustments. When the scale weight is below this entry, then the system will no longer use the scale data to make any more adjustment moves.

9. DRUM ACTUATOR TILT SETTINGS BUTTON:

Pressing this button will display a popup where the operator can change the drum tilt settings. (right) Startup Drum Tilt is the degrees the operator wishes the drum to be at when starting a run. Normal drum tilt is the desired tilt during the treating process. Shutdown drum tilt is the tilt setting during the shutdown process. Totalizer Weight to Start Normal Operation is the amount of seed needed to be calculated through the metering device to move the tilt from the startup to the normal tilt setting. Deadband degree is used to say when the drum is tilted close enough to its desired tilt to stop moving.

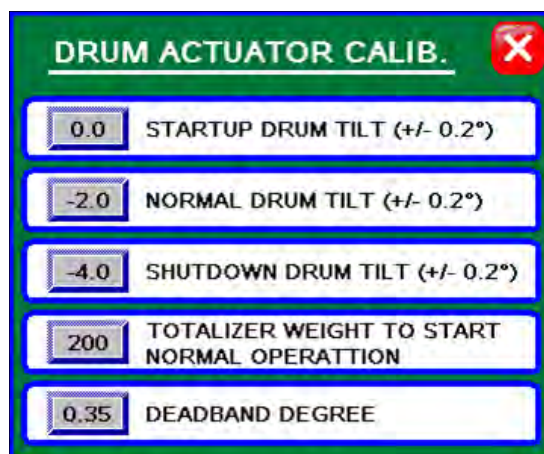

10. INDIVIDUAL PUMP TIMERS: When this box is not checked, the pump pre-set time and pump delay shut-off time buttons will display a number. Pressing these buttons brings up a numeric keypad to set the times for all pump stands globally from this screen. When the box is checked, these buttons toggle to Set Timers. Pressing these buttons will then activate a popup window that has a button for each individual pump stand allowing the operator to set different pre-start and delay times for each pump.

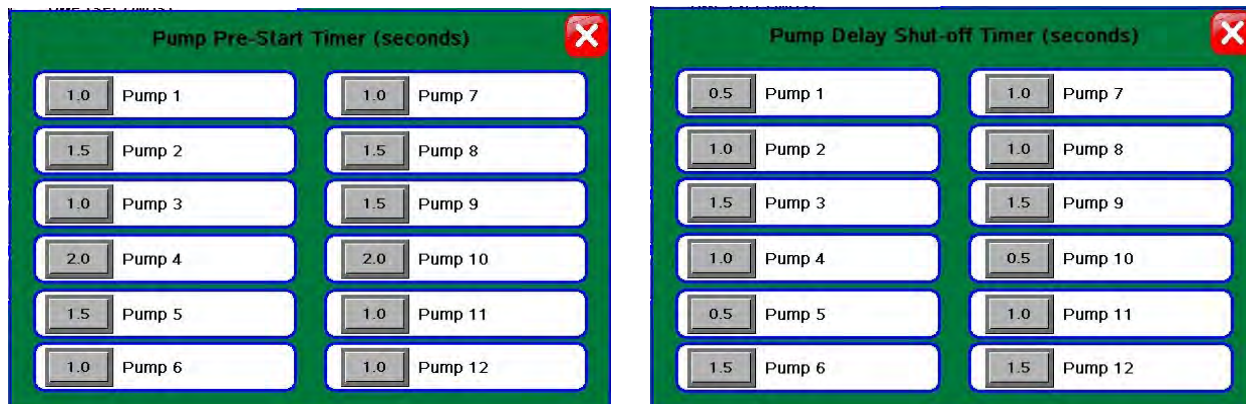

11. AUTO RATE ADJUST TO BIN SITE: (Only present when treater is used with a Tri - Flo ® and USC Bin Site Automation). When this box is checked, Target Treating Rate will automatically be adjusted to 2% slower than the bin site.

12. TREAT BY SCU / MIN: When this box is checked, the primary Target Treating Rate will be calculated in Seed Count Units per minute. Unchecked, it will be calculated in pounds per minute.

13. REPORTS: This button advances the operator to the Reports screen (see page 94).

14. CUSTOMER EDITING: This button advances the operator to the Customer Editing screen (see page 32).

15. PRODUCT EDITING: This button advances the operator to the Product Editing screen (see page 31).

16. RECIPE EDITING: This button advances the operator to the Recipe Editing screen (see page 29).

17. SECURITY: This button advances the operator to the Security screen (see page 25).

18. INFORMATION: This button advances the operator to the information screen where the operator can find vital information on storage and troubleshooting.

19. ABOUT USC: Pressing this button brings up a popup screen showing the operator what software release is installed.

BATCH HOPPER AUTOMATION

SECTION C-4

MAIN SCREEN

This screen informs the operator of the status of all system motors and electrical devices and allows for control / adjustment of system operations.

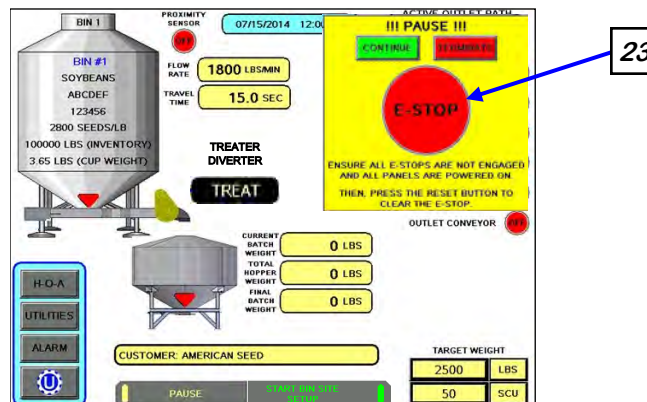
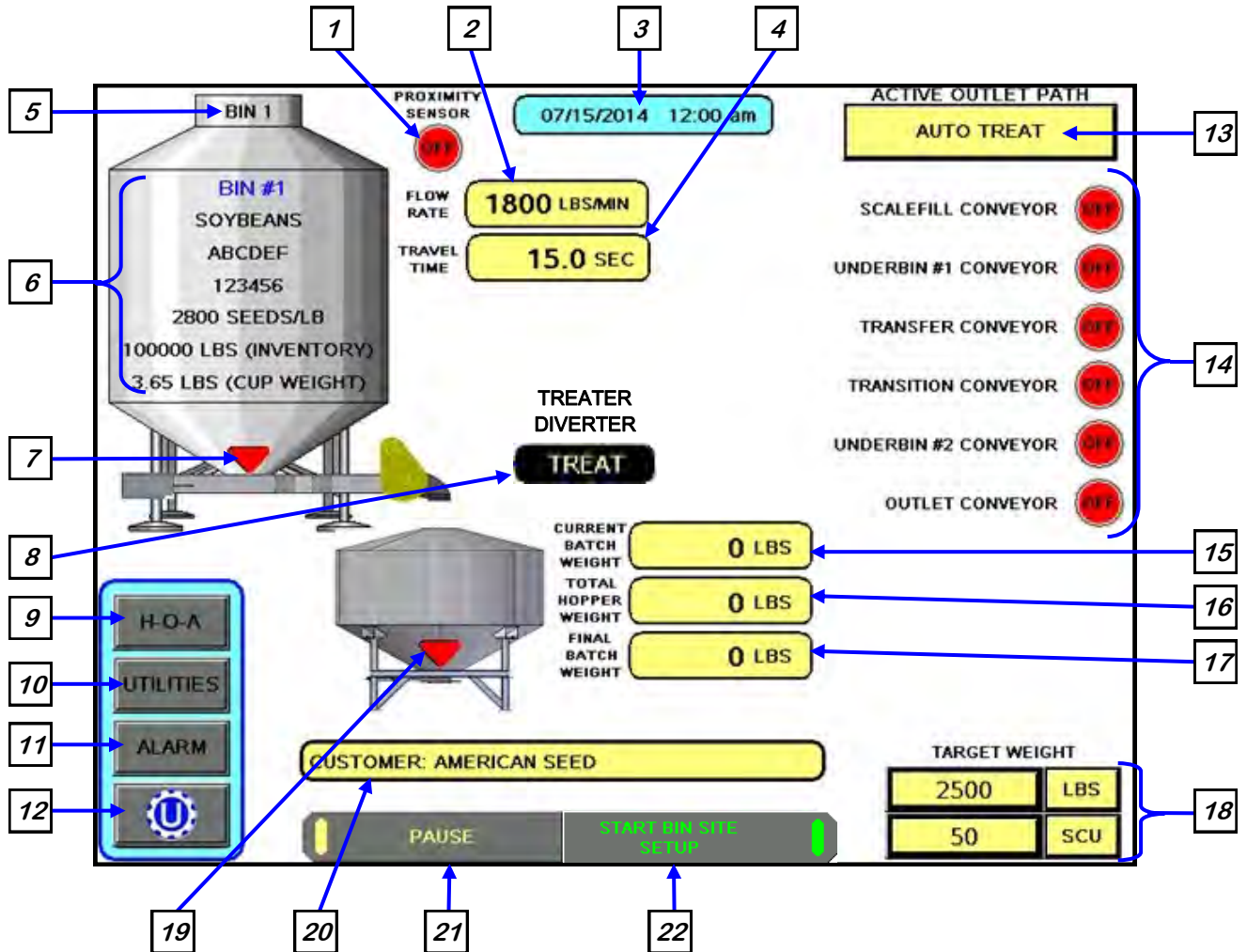

Main Screen Button Descriptions

- 1. INLET HOPPER PROXIMITY SWITCH INDICATOR (optional):** Informs the operator of the status of the proximity switch if one is located in the supply hopper on the treater. If the switch is ON (green) it is detecting seed. If it is OFF (red) it is not detecting seed. This is only used with manual treaters.
- 2. FLOW RATE DISPLAY:** Informs the operator of the flow rate of seed from the currently selected bin.
- 3. CURRENT DATE and TIME DISPLAY.**
- 4. TRAVEL TIME DISPLAY:** Informs the operator of the amount of time seed takes to flow from the currently selected bin to the batch hopper.
- 5. CURRENT BIN SELECTED:** Indicates the currently selected bin.
- 6. CURRENT BIN INFO:** Displays the bin information that has been entered into the currently selected bin. Includes seed type, seed variety, lot number, seeds/lb, amount in inventory and cup weight.
- 7. BIN SLIDE GATE INDICATOR:** Informs the operator of the slide gate position. If it is green the gate is OPEN. If it is red the gate is CLOSED.
- 8. DIVERTER INDICATOR (optional):** Informs the operator if the diverter is currently in the treat or bypass position. This indicator will only be present if the batch hopper system has a diverter.
- 9. H-O-A (Hand-Off-Auto) BUTTON:** This button advances the operator to the H-O-A screen (see page 73).
- 10. UTILITIES BUTTON:** This button advances the operator to the UTILITIES screen (see page 78).
- 11. ALARM BUTTON:** This button advances the operator to the ALARMS table (see page 149).
- 12. TREATER BUTTON (optional):** This button advances the operator to the treater main screen. This button is only available if the batch hopper system is being operated in conjunction with a PLC controlled seed treater.
- 13. ACTIVE OUTLET PATH INDICATOR:** This display shows the active path for the seed to follow. This can include treating the seed in auto or manual mode as well as bypassing the treater with a diverter and any necessary conveyors. The outlet paths are customizable and set based on the site configurations. Active mode will run both the bin site and treater in sequence with all corresponding conveyors. Manual mode will run just the bin site and the operator will need to go to the treater screen to start the treating process.

Main Screen Button Descriptions

14. CURRENT CONVEYOR MOTOR STATUS INDICATOR: Informs the operator if a particular conveyor motor is on or off.

15. CURRENT BATCH WEIGHT DISPLAY: Informs the operator of the current running total of seed that has entered the batch hopper system for this particular run of seed.

16. TOTAL HOPPER WEIGHT DISPLAY: Informs the operator of the current running total of seed that has entered the batch hopper at any given time.

17. FINAL BATCH WEIGHT DISPLAY: Informs the operator of the weight of seed that has been recorded by the scale printer and reporting system.

18. TARGET WEIGHT DISPLAY: This shows the operator the set target weight and target seed count units requested. This can be changed for a new run on the startup wizard where it allows the operator to enter the amount of seed that is to be pulled in from the selected bin. The operator can also select to call in seed via seed count units (SCU). If SCU is selected, the system will base the units upon the seed count defined for each product on the Edit Product Names screen. That number will vary depending on the type of seed.

19. BATCH WEIGH HOPPER SLIDE GATE INDICATOR: Informs the operator of the status of the air-actuated slide gate located at the bottom of the batch hopper. Green indicating the open position and red for the closed position

20. CUSTOMER DISPLAY: This displays the current customer for the run. If a new customer is needed for a new run you will select it after hitting the start button.

21. PAUSE BUTTON: Allows the operator to pause the ongoing process in the event of a set-up error or an alarm situation. Pushing this button will activate the pause screen (top). Once the issue is resolved push continue to re-start the process. Or use the terminate button.

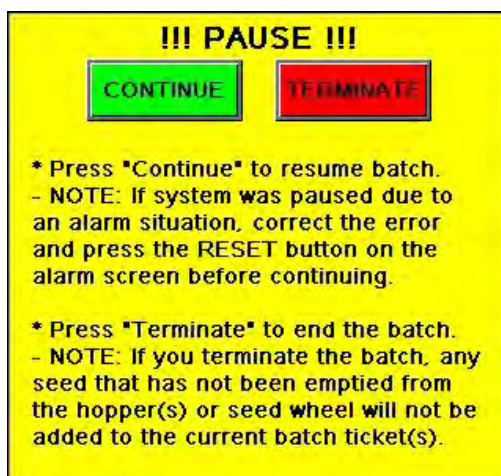

22. START SCALE FILL FROM BIN / HOPPER BUTTON: Pressing this button opens the START popup screen where the operator will select the desired customer, bin, target weight in pounds or SCU and the outlet path. The chemical recipe button will only be active if it is enabled on the chemical editing screen (see page 28). By pressing the gray boxes of the items you wish to change, a selection list will appear so that you can navigate to find the desired selection. The target weight boxes will bring up an alpha numeric keypad.

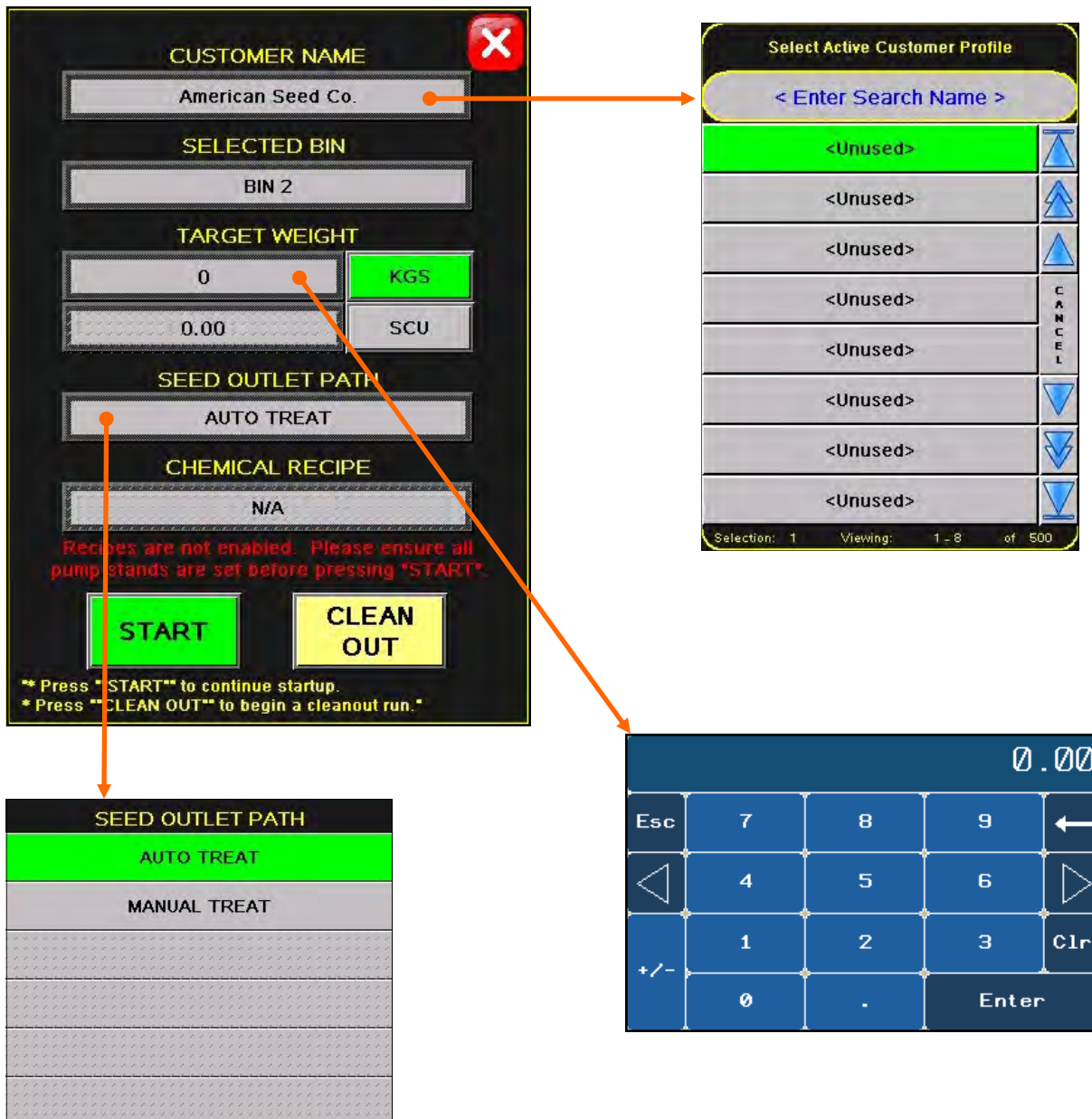

23. EMERGENCY STOP INDICATOR: This blinking display is activated when the system's E-Stop button is activated.

BATCH HOPPER “H-O-A” (HAND-OFF-AUTO) SCREEN

Hand-Off-Auto controls are provided for most of the automated devices in the system, and are accessed on this screen.



! AVERTISSEMENT

These H-O-A buttons force the selected component to be energized (HAND), de-energized (OFF), or automatically energized by the normal logic sequence (AUTO). The HAND function will cause the component to operate independent of whatever else the system is trying to do automatically. These functions should not normally be used if the automated sequencing is active. **Be sure to understand the impact of energizing or de-energizing a component with the HAND/Off settings before using them. These commands are not a substitute for Lockout/Tagout procedures when working on or near this machine. Use proper lockout/tagout procedures to disable the equipment before servicing it.**

Ces boutons HOA forcent le composant sélectionné pour être excité (HAND), hors tension (OFF), ou automatiquement alimentés par la séquence logique normale (AUTO). La fonction de la main provoquera la composante de fonctionner indépendamment de tout ce que le système essaie de faire automatiquement. Ces fonctions ne devraient normalement pas être utilisés si le séquençage automatisé est actif. Assurez-vous de comprendre l'impact de énergisant ou désexciter un composant avec la main / Off paramètres avant de les utiliser. Ces commandes ne sont pas un substitut pour les procédures de verrouillage / étiquetage lorsque vous travaillez sur ou près de cette machine. Utilisez les procédures appropriées de verrouillage / débranchement pour désactiver l'équipement avant de l'entretenir.

BATCH HOPPER “H-O-A” (HAND-OFF-AUTO) SCREEN

Hand-Off-Auto controls are provided for most of the automated devices in the system, and are accessed on this screen.

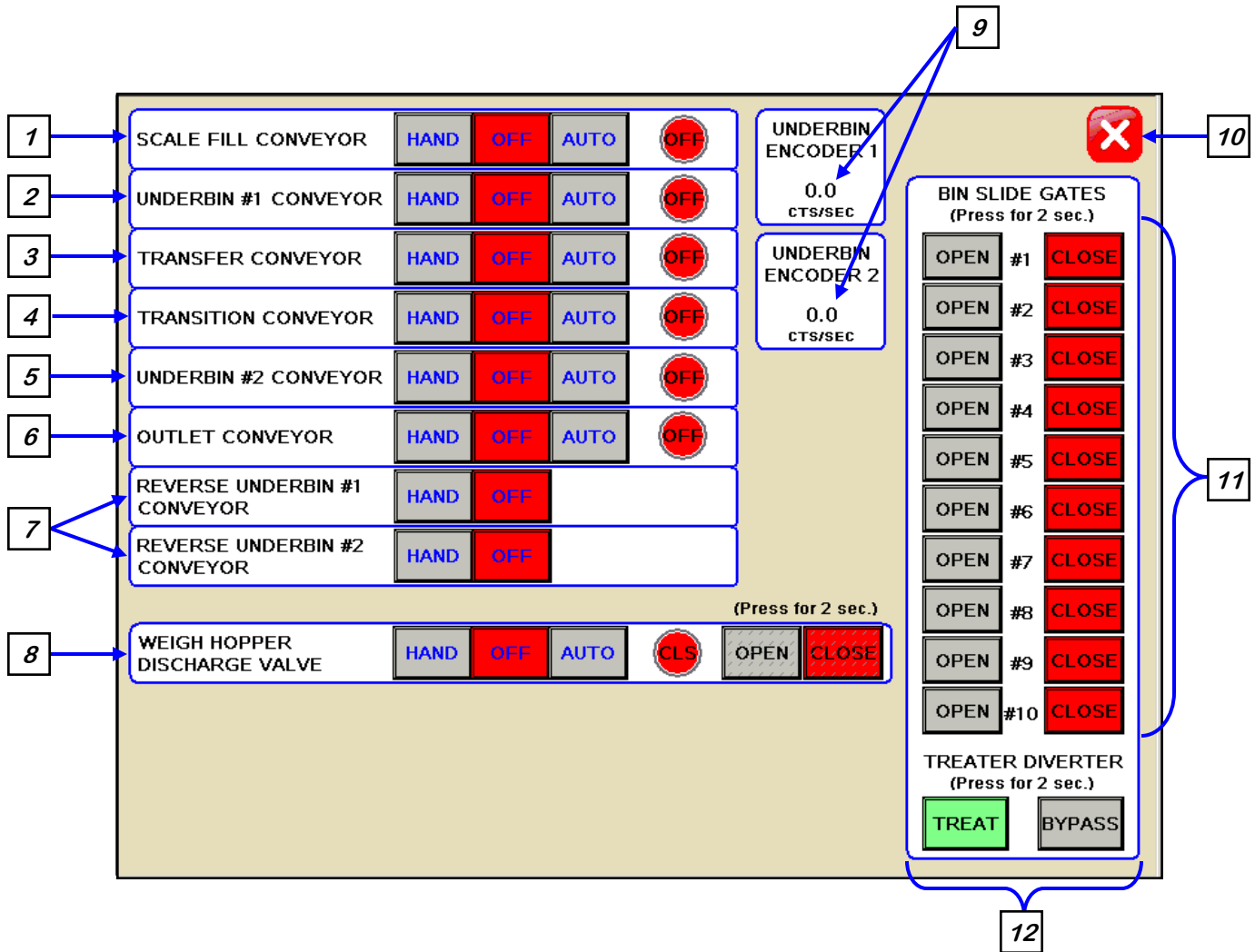

H-O-A Button Descriptions

1. SCALE FILL CONVEYOR CONTROL MODULE: This module controls the function of the scale fill conveyor. The HAND button will place the scale fill conveyor in the manual mode of operation. The OFF button will turn the associated device in the OFF mode of operation. The AUTO button will place the device in the automatic mode of operation. The motor will not operate in this mode unless all other needed devices are in the AUTO mode and the START SCALE FILL button is pressed on the Main screen.

2. UNDERBIN #1 CONVEYOR CONTROL MODULE: This module controls the function of the underbin #1 conveyor. The HAND button will place the underbin #1 conveyor in the manual mode of operation. The OFF button will turn the associated device in the OFF mode of operation. The AUTO button will place the device in the automatic mode of operation. The motor will not operate in this mode unless all other needed devices are in the AUTO mode and the START SCALE FILL button is pressed on the Main screen.

3. TRANSFER CONVEYOR CONTROL MODULE (optional): This module controls the function of the transfer conveyor. The HAND button will place the transfer conveyor in the manual mode of operation. The OFF button will turn the associated device in the OFF mode of operation. The AUTO button will place the device in the automatic mode of operation. The motor will not operate in this mode unless all other needed devices are in the AUTO mode and the START SCALE FILL button is pressed on the Main screen. This button will only be present if the batch hopper system has a transfer conveyor.

4. TRANSITION CONVEYOR CONTROL MODULE (optional): This module controls the function of the transition conveyor. The HAND button will place the transition conveyor in the manual mode of operation. The OFF button will turn the associated device in the OFF mode of operation. The AUTO button will place the device in the automatic mode of operation. The motor will not operate in this mode unless all other needed devices are in the AUTO mode and the START SCALE FILL button is pressed on the Main screen. This button will only be present if the batch hopper system has a transition conveyor.

H-O-A Button Descriptions

5. UNDERBIN #2 CONVEYOR” CONTROL MODULE (optional): This module controls the function of the underbin #2 conveyor. The HAND button will place the underbin #2 conveyor in the manual mode of operation. The OFF button will turn the associated device in the OFF mode of operation. The AUTO button will place the device in the automatic mode of operation. The motor will not operate in this mode unless all other needed devices are in the AUTO mode and the START SCALE FILL button is pressed on the Main screen. This button will only be present if the batch hopper system has a second underbin conveyor.

6. OUTLET CONVEYOR CONTROL MODULE: This module controls the function of the outlet conveyor. The HAND button will place the outlet conveyor in the manual mode of operation. The OFF button will turn the associated device in the OFF mode of operation. The AUTO button will place the device in the automatic mode of operation. The motor will not operate in this mode unless all other needed devices are in the AUTO mode and the START SCALE FILL button is pressed on the Main screen.

7. REVERSE UNDERBIN CONVEYOR CONTROL MODULE (optional): This module operates in the manual mode only. Pressing the HAND button allows the operator to run the underbin conveyor in reverse. **ALWAYS ENSURE THE BELT IS IMMEDIATELY AND PROPERLY ALIGNED WHEN RUNNING IN REVERSE! BELTS WILL OFTEN SHIFT ALIGNMENT WHEN THEIR DIRECTION OF TRAVEL IS REVERSED. BE SURE TO RE-CHECK THE ALIGNMENT AFTER IT IS RETURNED TO THE FORWARD DIRECTION.** This module will only be present if the bin site system has the reversing option for the underbin conveyor.

8. WEIGH HOPPER DISCHARGE VALVE CONTROL MODULE: This module controls the function of the hopper discharge valve located at the bottom of the batch hopper. The HAND button will place the discharge valve in the manual mode of operation. By pressing and holding for two seconds the OPEN or CLOSED button the operator can manually open or close the hopper discharge gate. The round indicator displays the valve status. CLS in red for closed and OPN in green for open. The OFF button will turn the associated device in the OFF mode of operation. The AUTO button will place the device in the automatic mode of operation and would then be controlled by the batch hopper PLC program.

H-O-A Button Descriptions

9. COUNTS PER SECOND DISPLAY (optional): This display shows the current counts per second that the underbin encoder is reading. This allows the bin site system to be sure that the underbin conveyor is running properly and that the belt is not slipping. This display will only be present if the bin site system has an underbin encoder on the underbin conveyor. If not working correctly, calibration of the seed flow will be affected.

10. SCREEN EXIT BUTTON: This button is used to exit back to the previous screen. Its functionality is the same throughout the HMI display.

11. BIN SLIDE GATES CONTROL MODULE: This module allows the operator to manually control the operation of the slide gates that are located underneath each bin. The bin slide gates will be opened and closed automatically when the operator presses the START SCALE FILL button on the Main screen.

12. DIVERTER CONTROL MODULE (optional): This module controls the function of the diverter. The module allows the operator to choose if the diverter is in the treat or bypass mode. In treat mode seed will be run through the treater and in bypass mode seed will be diverted so that it does not pass through the treater. This module will only be present if the batch hopper system has a diverter.

BATCH HOPPER UTILITIES SCREEN

This screen allows the operator to set various system parameters and gives access to the Bin Site Reports, Alarms, Security and Customer Info screens.

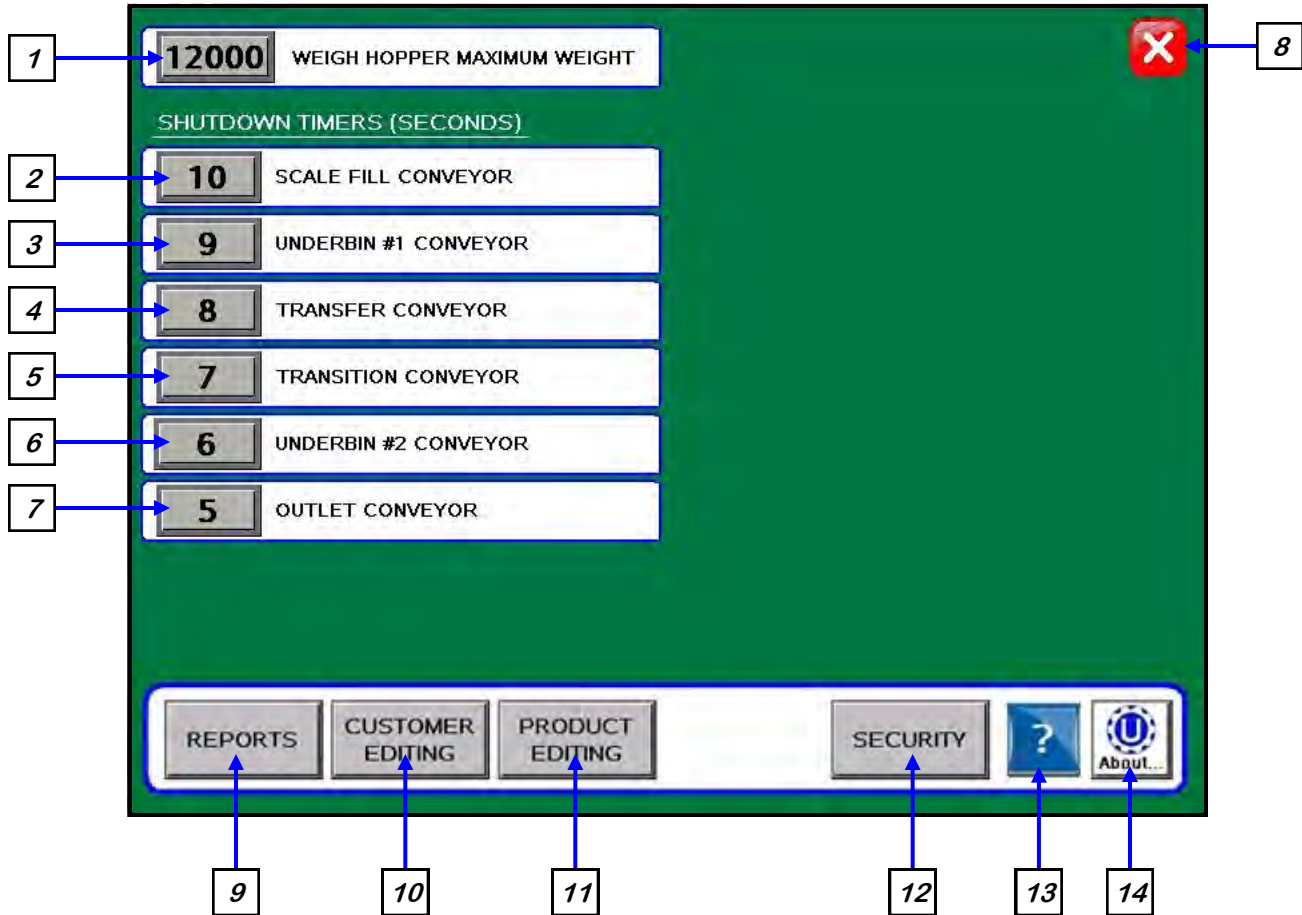

NOTICE

When buttons 1-7 are pressed, a numeric touch pad (right) will appear allowing the operator to enter in a number for that particular parameter.

AVIS

Lorsque les boutons sont pressés 1-7, un pavé tactile numérique (à droite) se affiche permettant à l'opérateur d'entrer dans un certain nombre de ce paramètre particulier.

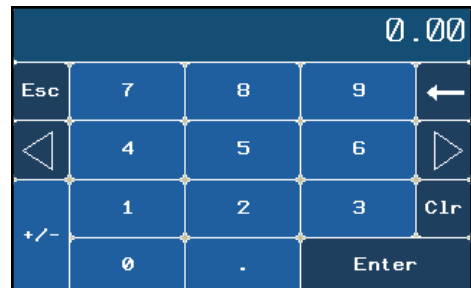

Utilities Screen Button Descriptions

1. MAXIMUM SCALE WEIGHT: Pressing this button allows the operator to adjust the maximum amount of seed that the scale can hold.

2. SCALE FILL CONVEYOR SHUTDOWN TIME: Pressing this button allows the operator to adjust the shutdown time of the scale fill conveyor.

3. UNDERBIN #1 CONVEYOR SHUTDOWN TIME: Pressing this button allows the operator to adjust the shutdown time of the underbin #1 conveyor. This timer will begin once the bin slide gate has closed and will allow the underbin conveyor to clean itself out.

4. TRANSFER CONVEYOR SHUTDOWN TIME (optional): Pressing this button allows the operator to adjust the shutdown time of the transfer conveyor. This timer will allow the Pro Box hopper to clean itself out. This button will only be present if the Pro Box hopper is being used.

5. TRANSITION CONVEYOR SHUTDOWN TIME (optional): Pressing this button allows the operator to adjust the shutdown time of the transition conveyor. This timer will allow the transition conveyor to clean itself out.

6. UNDERBIN #2 CONVEYOR SHUTDOWN TIME (optional): Pressing this button allows the operator to adjust the shutdown time of the underbin #2 conveyor. This timer will begin once the batch is finished and will allow the underbin conveyor to clean itself out. This button will only be present if the batch hopper system has a second underbin conveyor.

7. OUTLET CONVEYOR SHUTDOWN TIME: Pressing this button allows the operator to adjust the shutdown time of the outlet conveyor. This timer will always be set to the longest shutdown time to be sure all other conveyors and the treater have cleared themselves of seed and shutdown.

8. SCREEN EXIT BUTTON: Pressing this button is used to exit back to the previous screen. Its functionality is the same throughout the HMI display.

9. REPORTS BUTTON: Pressing this button advances the operator to the Reports screen.

10. CUSTOMER EDITING BUTTON: Pressing this button advances the operator to the Customer Editing screen (see page 32).

11. PRODUCT EDITING BUTTON: Pressing this button advances the operator to the Product Editing Screen (see page 30).

12. SECURITY BUTTON: Pressing this button advances the operator to the Security screen (see page 25).

13. HELP: Pressing this button takes the operator to the Help Screen where you can find common solutions for problems you may encounter.

14. ABOUT USC BUTTON: Pressing this button allows the operator see what software release is installed in the system.

SECTION C-5

TRI-FLO® AUTOMATION

MAIN SCREEN

This screen informs the operator of the status of all system motors and electrical devices and allows for control / adjustment of system operations.

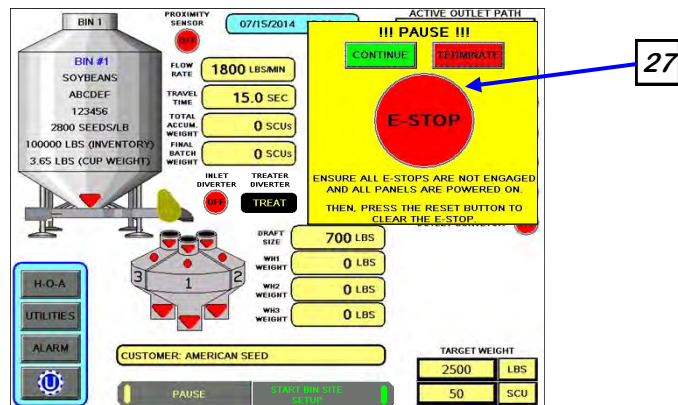
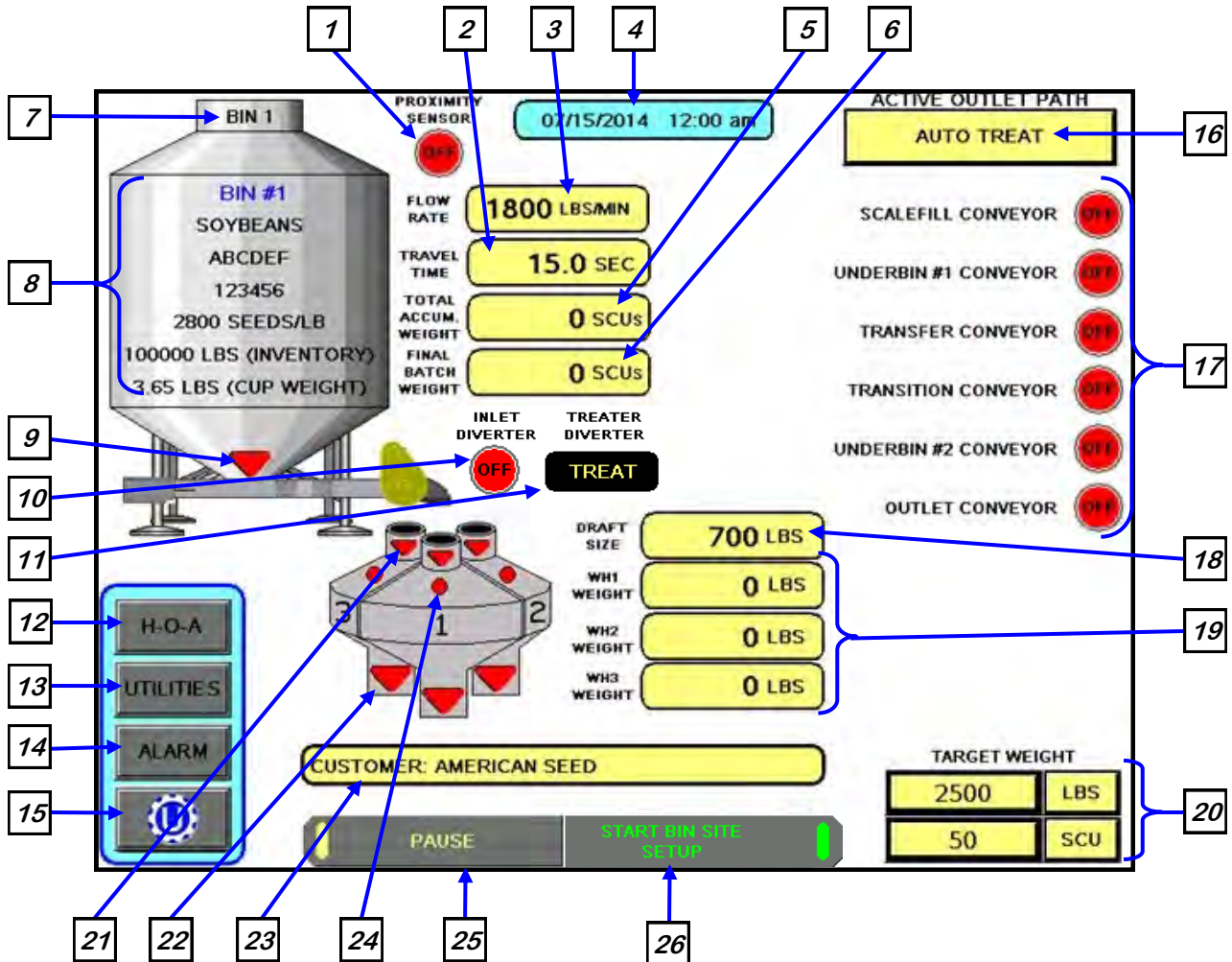

Main Screen Button Descriptions

- 1. INLET HOPPER PROXIMITY SWITCH INDICATOR (optional):** Informs the operator of the status of the proximity switch if one is located in the supply hopper on the treater. If the switch is ON (green) it is detecting seed. If it is OFF (red) it is not detecting seed. This is only used with a non-PLC based treaters.
- 2. TRAVEL TIME DISPLAY:** Informs the operator of the amount of time seed takes to flow from the currently selected bin to the Tri - Flo ® .
- 3. FLOW RATE DISPLAY:** Informs the operator of the flow rate of seed from the currently selected bin.
- 4. CURRENT DATE and TIME DISPLAY.**
- 5. TOTAL ACCUM. WEIGHT DISPLAY:** Informs the operator of the current running total of seed that has entered the Tri - Flo ® system for this particular run of seed.
- 6. FINAL BATCH WEIGHT DISPLAY:** Informs the operator of the weight of seed that has been recorded by the scale printer and has exited the Tri - Flo ® system during a given run of seed.
- 7. CURRENT BIN SELECTED:** Indicates the currently selected bin.
- 8. CURRENT BIN INFO:** Displays the bin information that has been entered into the currently selected bin. Includes seed type, seed variety, lot number, seeds/lb, amount in inventory and cup weight.
- 9. BIN SLIDE GATE INDICATOR:** Informs the operator of the slide gate position. If it is green the gate is OPEN. If it is red the gate is CLOSED.
- 10. TRI - FLO ® INLET DIVERTER MOTOR STATUS INDICATOR:** Informs the operator if the inlet diverter motor is on or off.
- 11. DIVERTER INDICATOR (optional):** Informs the operator if the diverter is currently in the treat or bypass position. This indicator will only be present if the Tri - Flo ® System has a diverter.
- 12. H-O-A (Hand-Off-Auto) BUTTON:** This button advances the operator to the H-O-A screen (see page 85).
- 13. UTILITIES BUTTON:** This button advances the operator to the UTILITIES screen (see page 90).
- 14. ALARM BUTTON:** This button advances the operator to the ALARMS table (see page 149).
- 15. TREATER BUTTON (optional):** This button advances the operator to the treater main screen. This button is only available if the Tri - Flo ® system is being operated in conjunction with a PLC controlled seed treater.

Main Screen Button Descriptions

16. ACTIVE OUTLET PATH DISPLAY: This display shows the active path for the seed to follow. This can include treating the seed in auto or manual mode as well as bypassing the treater with a diverter and any necessary conveyors. The outlet paths are customizable and set based on the site configurations. Active mode will run both the bin site and treater in sequence with all corresponding conveyors. Manual mode will run just the bin site and the operator will need to go to the treater screen to start the treating process.

17. CURRENT CONVEYOR MOTOR STATUS INDICATOR: Informs the operator if a particular conveyor motor is on or off.

18. DRAFT SIZE DISPLAY: Is the seed weight that is to be loaded into each hopper before the system rotates and begins to fill the next hopper.

19. WEIGH HOPPER DISPLAY: Gives the operator a real time running weight total for each of the three individual hoppers.

20. TARGET WEIGHT DISPLAY: This shows the operator the set target weight and target seed count units requested. This can be changed for a new run on the startup wizard where it allows the operator to enter the amount of seed that is to be pulled in from the selected bin. The operator can also select to call in seed via seed count units (SCU). If SCU is selected, the system will base the units upon the seed count defined for each product on the Edit Product Names screen. That number will vary depending on the type of seed.

21. TRI - FLO® INLET DIVERTER DISPLAY: Informs the operator which one of the three weigh hoppers the diverter is in position to load seed into. The active hopper will be green.

22. TRI - FLO® WEIGH HOPPER SLIDE GATE INDICATORS: Informs the operator of the status of the air-actuated slide gate located at the bottom of each hopper. Green indicating the open position and red for the closed position.

23. CUSTOMER DISPLAY: This displays the current customer for the run. If a new customer is needed for a new run you will select it after hitting the start button.

24. SEED PROXIMITY INDICATOR DISPLAY: Informs the operator when any one of the three hoppers is over full. Green indicates full.

25. PAUSE BUTTON: Allows the operator to pause the ongoing process in the event of a set-up error or an alarm situation. Pushing this button will activate the pause screen (right). Once the issue is resolved push CONTINUE to re-start the process. Or use the TERMINATE button.

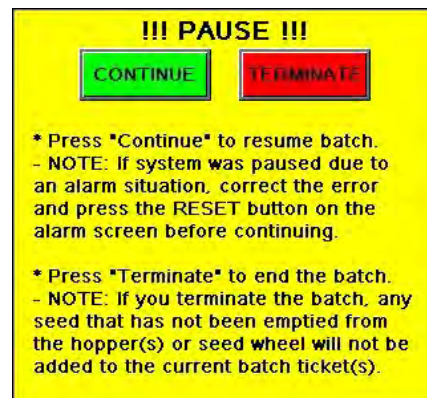

Main Screen Button Descriptions

26. START SCALE FILL FROM BIN/HOPPER BUTTON: Pressing this button opens the START popup screen where the operator may choose to run from a manual hopper or from a bin. They will also select the customer, target weight in pounds or SCUs desired and the outlet path. The chemical recipe button will only be active if it is enabled on the chemical recipe screen. If for any reason after a run there is seed left in any of the weigh hoppers or conveyors you may run Clean Out. The Clean Out functions the same as a regular run except with the bin slide gate closed. After all seed has been weighed and cleared from the system a separate report is generated accounting for the weight of that seed. By pressing the gray boxes of the items you wish to change, a selection list will appear so that you can navigate to find the desired selection. The target weight boxes will bring up an alpha numeric keypad.

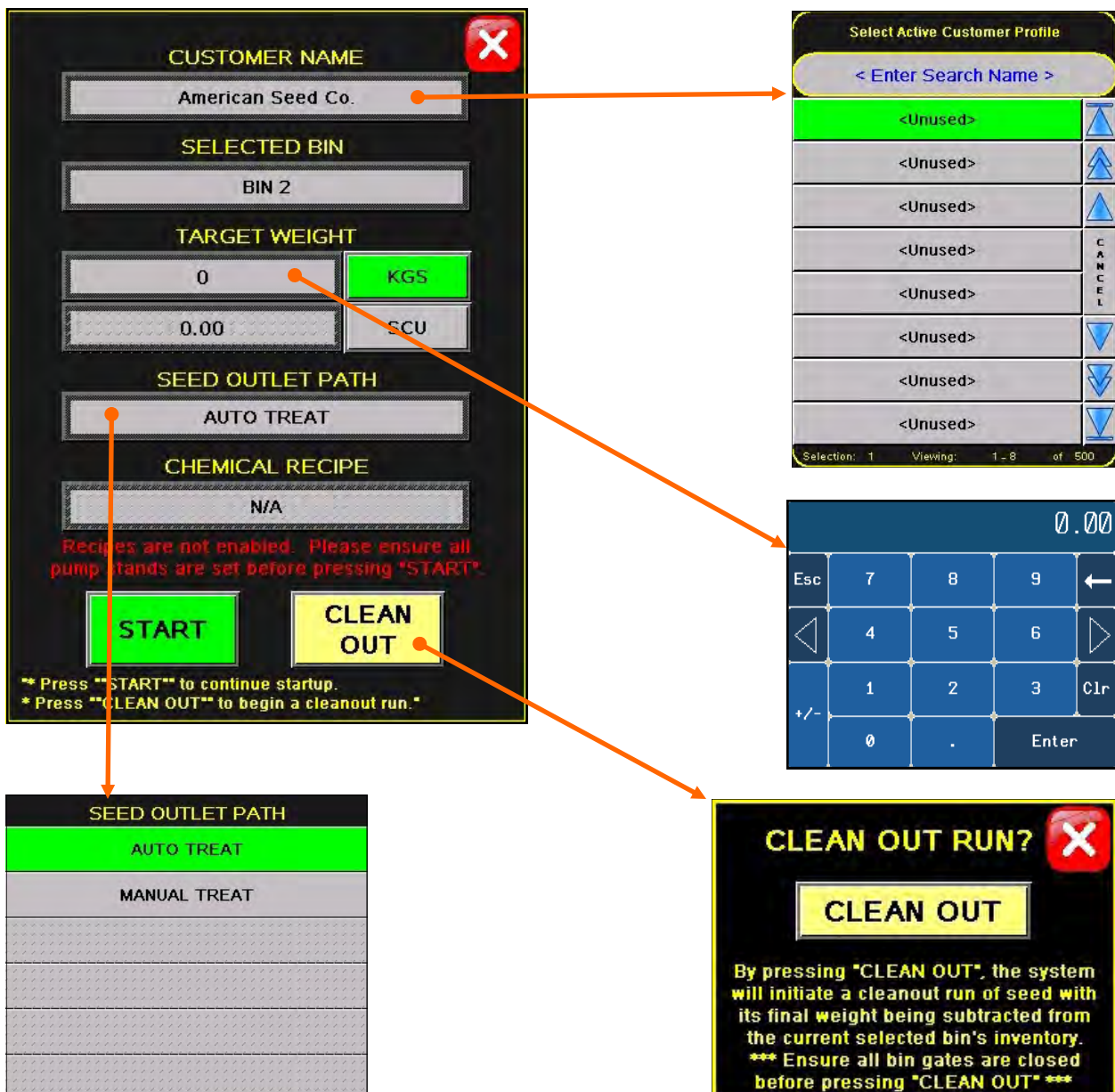

Main Screen Button Descriptions

26. (continued): If the operator is running from Manual Hopper a verification screen (right) appears to allow them to modify any of the Pro Box information for that particular run. The Treater Flow Rate is displayed on the right side of this screen. The operator may select the button and change the Treater Flow Rate without having to return to the Main Treater screen.



27. EMERGENCY STOP INDICATOR: This blinking display is activated when the system's E-Stop button is activated.

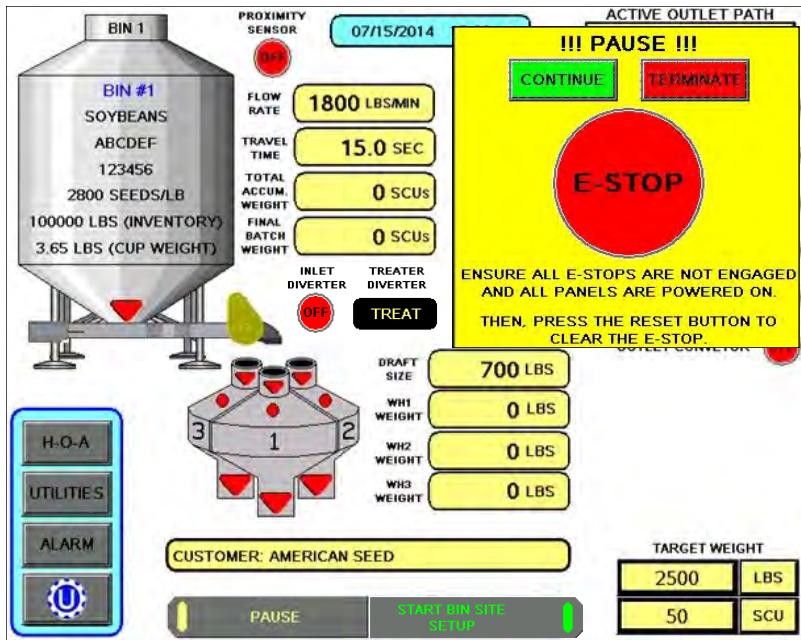

TRI - FLO® “H-O-A” (HAND-OFF-AUTO) SCREEN

Hand-Off-Auto controls are provided for most of the automated devices in the system, and are accessed on this screen.



! AVERTISSEMENT

These H-O-A buttons force the selected component to be energized (HAND), de-energized (OFF), or automatically energized by the normal logic sequence (AUTO). The HAND function will cause the component to operate independent of whatever else the system is trying to do automatically. These functions should not normally be used if the automated sequencing is active. **Be sure to understand the impact of energizing or de-energizing a component with the HAND/Off settings before using them. These commands are not a substitute for Lockout/Tagout procedures when working on or near this machine. Use proper lockout/tagout procedures to disable the equipment before servicing it.**

Ces boutons HOA forcent le composant sélectionné pour être excité (HAND), hors tension (OFF), ou automatiquement alimentés par la séquence logique normale (AUTO). La fonction de la main provoquera la composante de fonctionner indépendamment de tout ce que le système essaie de faire automatiquement. Ces fonctions ne devraient normalement pas être utilisés si le séquençage automatisé est actif. Assurez-vous de comprendre l'impact de énérgisant ou désexciter un composant avec la main / Off paramètres avant de les utiliser. Ces commandes ne sont pas un substitut pour les procédures de verrouillage / étiquetage lorsque vous travaillez sur ou près de cette machine. Utilisez les procédures appropriées de verrouillage / débranchement pour désactiver l'équipement avant de l'entretenir.

TRI - FLO® “H-O-A” (HAND-OFF-AUTO) SCREEN

Hand-Off-Auto controls are provided for most of the automated devices in the system, and are accessed on this screen.

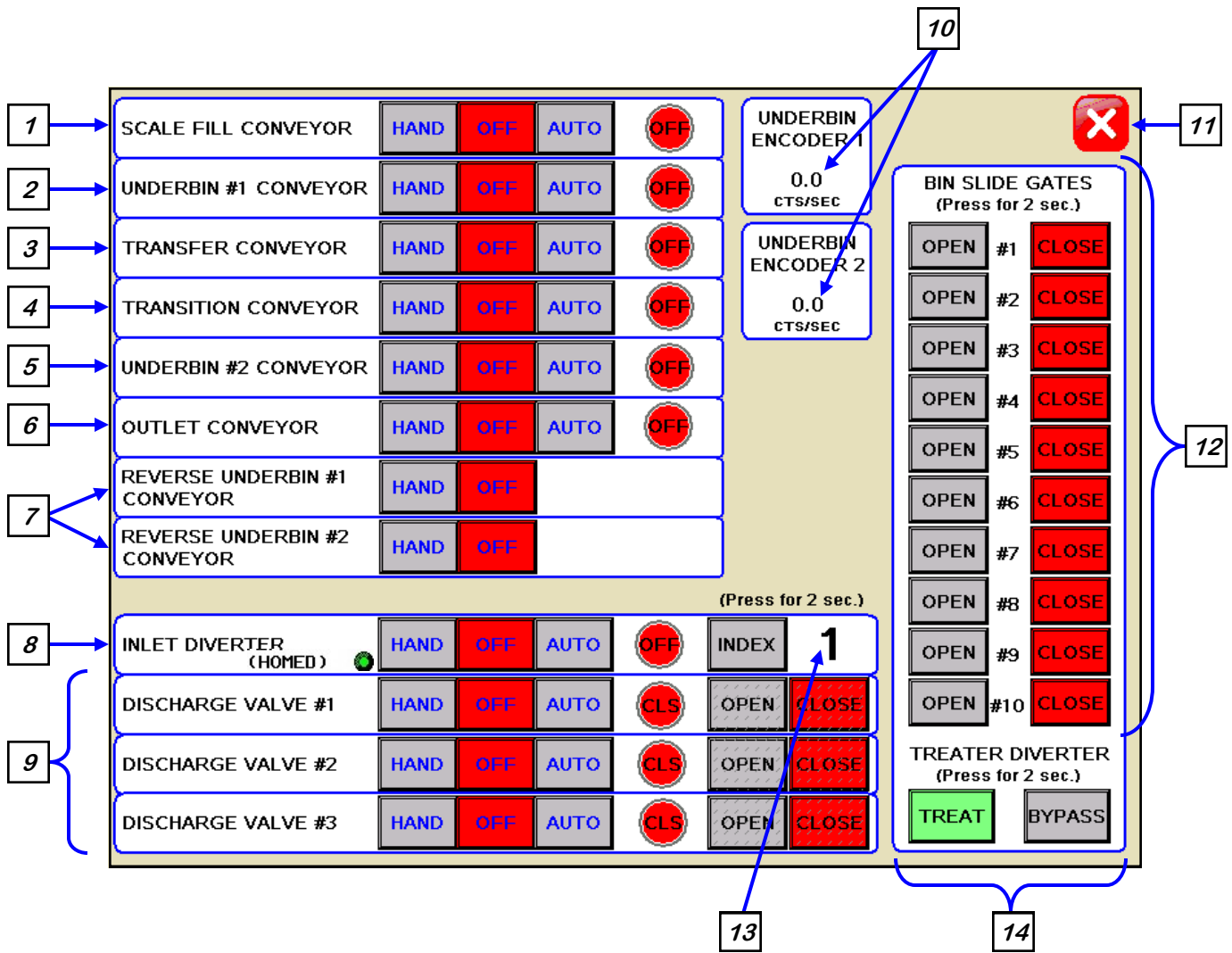

H-O-A Button Descriptions

1. SCALE FILL CONVEYOR CONTROL MODULE: This module controls the function of the scale fill conveyor. The HAND button will place the scale fill conveyor in the manual mode of operation. The OFF button will turn the associated device in the OFF mode of operation. The AUTO button will place the device in the automatic mode of operation. The motor will not operate in this mode unless all other needed devices are in the AUTO mode and the START SCALE FILL button is pressed on the Main screen.

2. UNDERBIN #1 CONVEYOR CONTROL MODULE: This module controls the function of the underbin #1 conveyor. The HAND button will place the underbin #1 conveyor in the manual mode of operation. The OFF button will turn the associated device in the OFF mode of operation. The AUTO button will place the device in the automatic mode of operation. The motor will not operate in this mode unless all other needed devices are in the AUTO mode and the START SCALE FILL button is pressed on the Main screen.

3. TRANSFER CONVEYOR CONTROL MODULE (optional): This module controls the function of the transfer conveyor. The HAND button will place the transfer conveyor in the manual mode of operation. The OFF button will turn the associated device in the OFF mode of operation. The AUTO button will place the device in the automatic mode of operation. The motor will not operate in this mode unless all other needed devices are in the AUTO mode and the START SCALE FILL button is pressed on the Main screen. This button will only be present if the Tri - Flo ® System has a transfer conveyor.

4. TRANSITION CONVEYOR CONTROL MODULE (optional): This module controls the function of the transition conveyor. The HAND button will place the transition conveyor in the manual mode of operation. The OFF button will turn the associated device in the OFF mode of operation. The AUTO button will place the device in the automatic mode of operation. The motor will not operate in this mode unless all other needed devices are in the AUTO mode and the START SCALE FILL button is pressed on the Main screen. This button will only be present if the Tri - Flo ® system has a transition conveyor.

H-O-A Button Descriptions

5. UNDERBIN #2 CONVEYOR” CONTROL MODULE (optional): This module controls the function of the underbin #2 conveyor. The HAND button will place the underbin #2 conveyor in the manual mode of operation. The OFF button will turn the associated device in the OFF mode of operation. The AUTO button will place the device in the automatic mode of operation. The motor will not operate in this mode unless all other needed devices are in the AUTO mode and the START SCALE FILL button is pressed on the Main screen. This button will only be present if the Tri - Flo ® system has a second underbin conveyor.

6. OUTLET CONVEYOR CONTROL MODULE: This module controls the function of the outlet conveyor. The HAND button will place the outlet conveyor in the manual mode of operation. The OFF button will turn the associated device in the OFF mode of operation. The AUTO button will place the device in the automatic mode of operation. The motor will not operate in this mode unless all other needed devices are in the AUTO mode and the START SCALE FILL button is pressed on the Main screen.

7. REVERSE UNDERBIN CONVEYOR CONTROL MODULE (optional): This module operates in the manual mode only. Pressing the HAND button allows the operator to run the underbin conveyor in reverse. **ALWAYS ENSURE THE BELT IS IMMEDIATELY AND PROPERLY ALIGNED WHEN RUNNING IN REVERSE! BELTS WILL OFTEN SHIFT ALIGNMENT WHEN THEIR DIRECTION OF TRAVEL IS REVERSED. BE SURE TO RE-CHECK THE ALIGNMENT AFTER IT IS RETURNED TO THE FORWARD DIRECTION.** This module will only be present if the bin site system has the reversing option for the underbin conveyor.

8. TRI - FLO® INLET DIVERTER CONTROL MODULE : This module controls the function of the inlet diverter. The HAND button will place the inlet diverter in the manual mode of operation. The OFF button will turn the associated device in the OFF mode of operation. The AUTO button will place the device in the automatic mode of operation and would then be controlled by the Tri - Flo ® PLC program. When the (HOMED) indicator is green, the inlet is at the number 1 hopper.

9. TRI - FLO® WEIGH HOPPER DISCHARGE VALVE CONTROL MODULE: This module controls the function of the hopper discharge valve located at the bottom of each of the three individual hoppers. The HAND button will place the discharge valve in the manual mode of operation. The OFF button will turn the associated device in the OFF mode of operation. The AUTO button will place the device in the automatic mode of operation and would then be controlled by the Tri - Flo ® PLC program.

H-O-A Button Descriptions

10. COUNTS PER SECOND DISPLAY (optional): This display shows the current counts per second that the underbin encoder is reading. This allows the bin site system to be sure that the underbin conveyor is running properly and that the belt is not slipping. This display will only be present if the bin site system has an underbin encoder on the underbin conveyor. If not working correctly, calibration of the seed flow will be affected.

11. SCREEN EXIT BUTTON: This button is used to exit back to the previous screen. Its functionality is the same throughout the HMI display.

12. BIN SLIDE GATES CONTROL MODULE: This module allows the operator to manually control the operation of the slide gates that are located underneath each bin. The bin slide gates will be opened and closed automatically when the operator presses the START SCALE FILL button on the Main screen.

13. TRI - FLO® INLET DIVERTER INDEX DISPLAY: Informs the operator which one of the three weigh hoppers the diverter is in position to load seed into. The active hopper will be green on the main screen.

14. DIVERTER CONTROL MODULE (optional): This module controls the function of the diverter. The module allows the operator to choose if the diverter is in the treat or bypass mode. In treat mode seed will be run through the treater and in bypass mode seed will be diverted so that it does not pass through the treater. This module will only be present if the Tri - Flo® system has a diverter.

TRI - FLO® UTILITIES SCREEN

This screen allows the operator to set various system parameters and gives access to the Bin Site Reports, Alarms, Security and Customer Info screens.

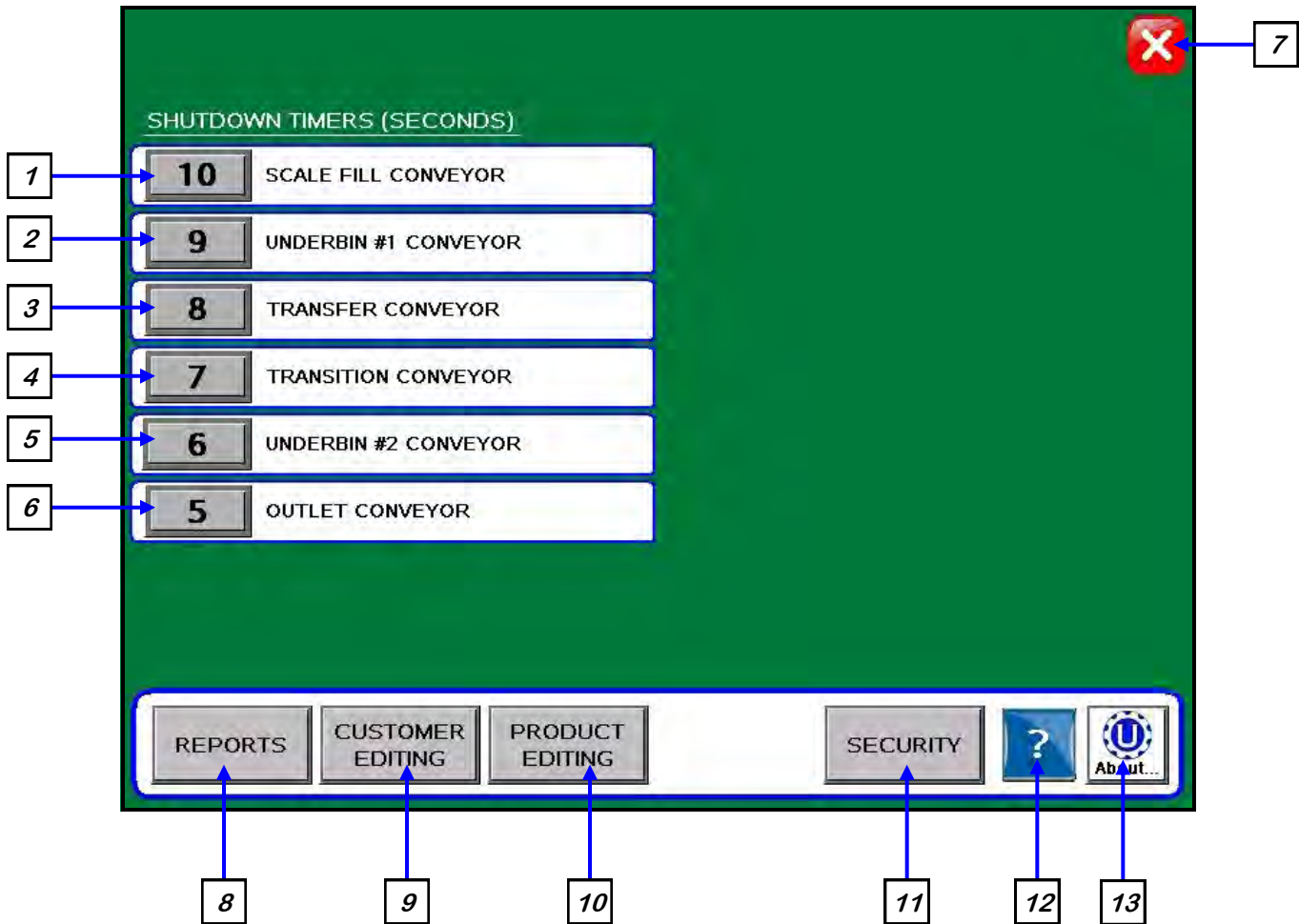

NOTICE

When buttons 1-6 are pressed, a numeric touch pad (right) will appear allowing the operator to enter in a number for that particular parameter.

AVIS

Lorsque les boutons sont pressés 1-6, un pavé tactile numérique (à droite) se affiche permettant à l'opérateur d'entrer dans un certain nombre de ce paramètre particulier.

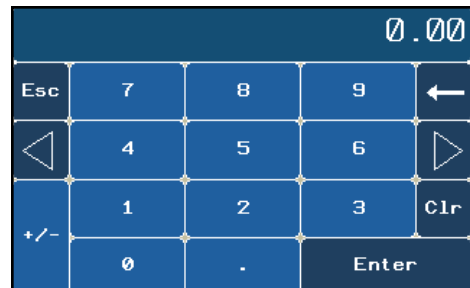

Utilities Screen Button Descriptions

- 1. SCALE FILL CONVEYOR SHUTDOWN TIME:** Pressing this button allows the operator to adjust the shutdown time of the scale fill conveyor.
- 2. UNDERBIN #1 CONVEYOR SHUTDOWN TIME:** Pressing this button allows the operator to adjust the shutdown time of the underbin #1 conveyor. This timer will begin once the bin slide gate has closed and will allow the underbin conveyor to clean itself out.
- 3. TRANSFER CONVEYOR SHUTDOWN TIME (optional):** Pressing this button allows the operator to adjust the shutdown time of the transfer conveyor. This timer will allow the Pro Box hopper to clean itself out. This button will only be present if the Pro Box hopper is being used.
- 4. TRANSITION CONVEYOR SHUTDOWN TIME (optional):** Pressing this button allows the operator to adjust the shutdown time of the transition conveyor. This timer will allow the transition conveyor to clean itself out.
- 5. UNDERBIN #2 CONVEYOR SHUTDOWN TIME (optional):** Pressing this button allows the operator to adjust the shutdown time of the underbin #2 conveyor. This timer will begin once the batch is finished and will allow the underbin conveyor to clean itself out. This button will only be present if the Tri - Flo ® System has a second underbin conveyor.
- 6. OUTLET CONVEYOR SHUTDOWN TIME:** Pressing this button allows the operator to adjust the shutdown time of the outlet conveyor. This timer will always be set to the longest shutdown time to be sure all other conveyors and the treater have cleared themselves of seed and shutdown.
- 7. SCREEN EXIT BUTTON:** Pressing this button is used to exit back to the previous screen. Its functionality is the same throughout the HMI display.
- 8. REPORTS BUTTON:** Pressing this button advances the operator to the Reports screen (page 94).
- 9. CUSTOMER EDITING BUTTON:** Pressing this button advances the operator to the Customer Editing screen (see page 32).
- 10. PRODUCT EDITING BUTTON:** Pressing this button advances the operator to the Product Editing screen (see page 30).
- 11. SECURITY BUTTON:** Pressing this button advances the operator to the Security screen (see page 25).
- 12. HELP:** Pressing this button takes the operator to the Help Screen where you can find common solutions for problems you may encounter.
- 13. ABOUT USC BUTTON:** Pressing this button allows the operator see what software release is installed in the system.

SECTION
D**CALIBRATION & OPERATION****DETERMINING SEED CUP WEIGHT**

The following is a list of steps to use when calibrating the seed wheel. A seed calibration cup, funnel, stand, and scale are used to calibrate the seed wheel.

1. Set the empty seed calibration cup on the scale and zero out the weight of the cup.
2. Place the funnel and stand in the seed to be treated or a separate container (see page 93, figure 1). This will help to avoid any unnecessary clean-up while filling and leveling the top of the seed calibration cup.
3. Place your hand under the bottom of the funnel and fill the funnel up with seed.
4. Place the calibration cup under the funnel stand and remove your hand from the bottom of the funnel, and allow the cup to be filled (see page 93, figure 1).
5. After the cup has been filled, strike off the top of the calibration cup with a straight edge (see page 93, figure 2).



Seed Calibration Cup

NOTICE

Do not shake the cup.

AVIS

Ne secouez pas la tasse.

6. Weigh the sample of seed (see page 93, figure 3).

NOTICE

A typical weight of the sample of seed will be anywhere between 2.8 to 4.0 lbs. Anything over or under this range could be caused by not zeroing out the weight of the cup, or the scale may be set on the wrong units.

AVIS

Un poids typique de l'échantillon de semences sera ne importe où entre 2,8 à 4,0 livres. Tout sur ou sous cette fourchette pourrait être causée par la réduction à zéro ne pas le poids de la tasse, ou la balance peut être réglé sur les mauvaises unités.

DETERMINING SEED CUP WEIGHT

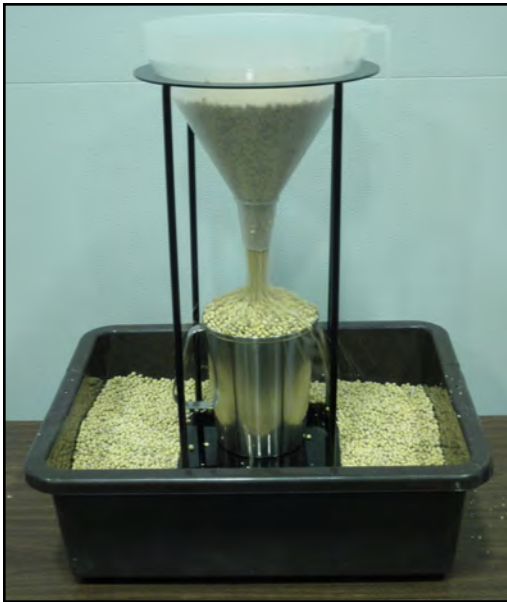

Figure 1



Figure 2



Figure 3

NOTICE

When U-Treat is being used to run a Bayer RH series treater, use the cup and scale provided with that treater to measure the cup weight. The RH scale measures in grams not pounds.

AVIS

Lorsque U-Treat est utilisé pour exécuter une série treater Bayer RH, utilisez la tasse et échelle fournie avec ce purificateur pour mesurer le poids de la tasse. Les mesures à l'échelle de SR dans grammes non livres.

**SECTION
D-1**

GENERAL CALIBRATION & OPERATION

VIEWING & PRINTING REPORTS

The following steps explain how reports are accessed and can be managed after a run has been completed.

1. After the SHUTDOWN button has been pressed a window will pop-up notifying the operator that the system will shut down after a specified amount of time. (right)



2. Once a run is finished the data is saved automatically in the reports file. The operator may access these records from the UTILITIES screen by pressing the REPORTS button that will bring up the screen below. On the left side of the screen is a list of report records. Use the arrows to scroll up or down the list. If you know the record number for the report, select the jump to record box and key it in. The record will appear at the top of the list. To see the report details, select the record you want and the information will appear to the right. To view more details, press the View Full Details button in the lower right corner. This screen will display customer, seed profile and chemical treatment information (see page 95, top). If emailing is enabled you will see an EMAIL buttons that allow you to email an individual record or all records in the file. You may also choose to print a record from this screen (see page 95, middle & bottom) .

Job Report Records

2015/12/03, 14:08:00-Treater	▲
2015/12/03, 14:08:53-Bin Site	▲
2015/12/03, 14:17:42-Treater	▲
2015/12/03, 14:18:35-Bin Site	▲
2015/12/03, 14:35:25-Treater	▲
2015/12/03, 14:36:18-Bin Site	▼
2015/12/03, 14:46:06-Treater	▼
2015/12/03, 14:46:59-Bin Site	▼

Selection: 31 Viewing: 25 - 32 of 10000
Total Used Records: 83
DB Status:
Jump To Record #: 25

REPORTS

Record Details: Job Report #31

Record Type: Treater
Date: 2015/12/03 14:46:06
System Paused: FALSE
Measurement Mode: U.S.
Customer Name: CUSTOMER 1
Seed Profile: SOYBEANS 1
Avg. Weight/min.: 480
Avg. SCU/min.: 879
Auxiliary Used: FALSE
Run Timer (Sec.): 35

Chemical Name	Total oz.
Pump #1: CHEMICAL 1	342
Pump #2: CHEMICAL 4	0.0
Pump #3: CHEMICAL 7	0.0
Pump #4:	0.0
Pump #5:	0.0
Pump #6:	0.0
Pump #7:	0.0
Pump #8:	0.0

EMAIL ALL EMAIL PRINT VIEW FULL DETAILS NOTES SAVE

U-TREAT AUTOMATION MANUAL

VIEWING & PRINTING REPORTS

Record Details: Job Report #31		
Customer Name: CUSTOMER 1 Address #1: 1234 SARETHA KS Address #2: Phone Number: Record Type: Treater Start Time: 2015/12/03 14:43:46 End Time: 2015/12/03 14:46:06 System Paused: FALSE Measurement Mode: U.S. Recipe: N/A Auxiliary Used: FALSE	Seed Profile: SOYBEANS 1 Variety: Lot Number: Seeds/Unit: 140000 Seeds/Weight: 2800 Weight/SCU: 50.00 Calibration Ratio: 2.49 Run Time (Sec.): 3.6 Target Weight: 502 Target SCUs: 10.04 Avg. Weight/min.: 490 Avg. SCU/min.: 9.79	
Chemical Name	Total oz.	% ACC
Pump #1: CHEMICAL 1	34.2	0.12
Pump #2: CHEMICAL 4	0.0	
Pump #3: CHEMICAL 7	0.0	
Pump #4:	0.0	
Pump #5:	0.0	
Pump #6:	0.0	
Pump #7:	0.0	
Pump #8:	0.0	

- Press the PRINT button and a popup window appears. From this screen you may enter the number of reports to print for the customers records. Then press the X in the top right corner of the screen to exit back to the reports screen.

NUMBER OF BIN SITE REPORTS TO PRINT X

1

NUMBER OF BIN SITE REPORTS PRINTED

0

PRINT

Pressing "X" or moving off of the current screen will cancel future print operations.

- If the Auto Print Report has been activated on the Print Set-up screen (see page 33) , steps 2 and 3 will not be required. The print verification screen will appear and automatically print the number of reports specified.

NUMBER OF TREATER REPORTS TO PRINT X

1

NUMBER OF TREATER REPORTS PRINTED

0

PRINT

Pressing "X" or moving off of the current screen will cancel future print operations.

VIEWING & PRINTING REPORTS

- If you would like to erase the reports, press the SECURITY button under the UTILITIES screen. Enter the password **USC**, then press the TOOLS & OPTIONS button. From this screen press the IMPORT / EXPORT LISTS button. On this screen you will find the Job Reports List with the option to Export or Delete the records. If you intend to deleted the reports, USC strongly recommends you first export them to a flash drive to preserve for your records.

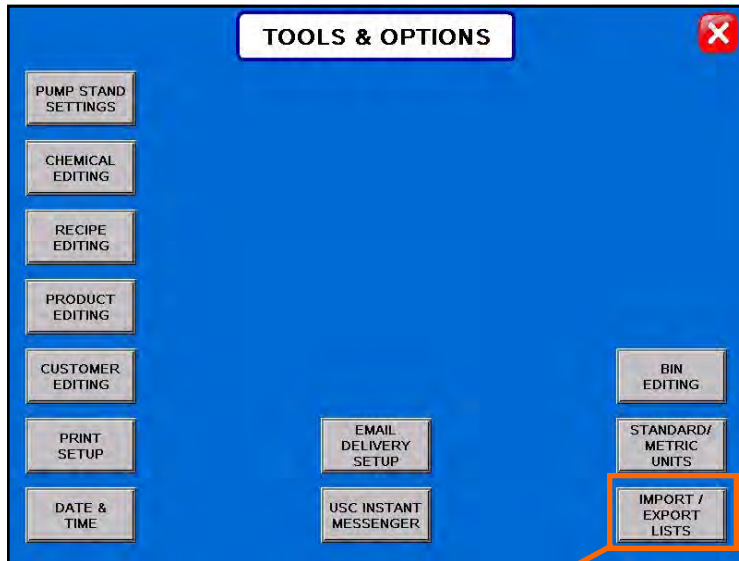

IMPORT / EXPORT

USB Status: Connected. Select the specific list you would like to export, import or delete. Import/Export Status:

List	Total Used Records	Status	Actions	
Alarm Log	141		Export	Delete
Job Reports	57		Export	Delete
Customer Profiles	8		Export	Import
Seed Profiles	8		Export	Import
Chemical Profiles	8		Export	Import
Chemical Recipes	13		Export	Import
Pump Profiles	9		Export	Import
Bin Profiles	2		Export	Import
Conveyors Profile	0		Export	Import
Outlet Paths Profile	2		Export	Import

DOWNLOADING REPORTS

The USB port located on the bottom of the Main Control Panel allows the operator to download reports to a compact flash device.

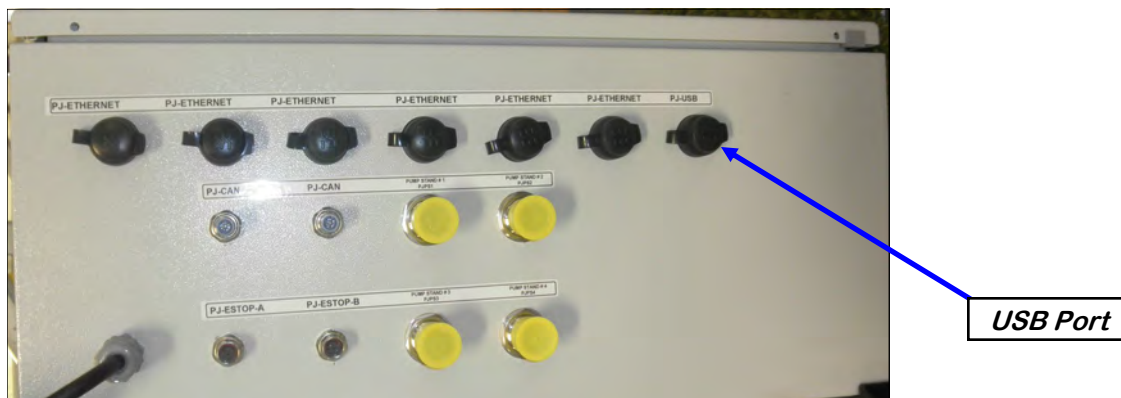

Use the following steps to download reports to a computer.

1. Insert a Compact Flash device into the USB port. The Flash device must be in Fat 32 format. The Import / Export screen will not function unless a flash drive is detected in the USB port.
2. From the main screen press, UTILITIES, SECURITY then Tools & Options.
3. Press the IMPORT / EXPORT LISTS button. Find the Job Reports List section and press Export. The data transfer status will appear above the export button until it is finished and the do not exit screen warning will appear above the module. When it has disappeared the reports have been copied.
4. Remove the compact flash device from the control panel and insert into your computer. Double click on the file name and the reports will be displayed in EXCEL format.

IMPORT / EXPORT			
USB Status: Connected.	Select the specific list you would like to export, import or delete.		Import/Export Status: Please do not *Exit* or cycle power.
List	Total Used Records	Status	Actions
Alarm Log	141		Export Delete
Job Reports	57		Export Delete
Customer Profiles	8		Export Import
Seed Profiles	8		Export Import
Chemical Profiles	8		Export Import
Chemical Recipes	13		Export Import
Pump Profiles	9		Export Import
Bin Profiles	2		Export Import
Conveyors Profile	0		Export Import
Outlet Paths Profile	2		Export Import

SECTION
D-2

TREATER CALIBRATION & OPERATION

SEED FLOW CALIBRATION FOR TREATERS WITH SEED WHEELS

1. Press the UTILITIES button and enter in the TARGET TREATING RATE at the top of the screen.

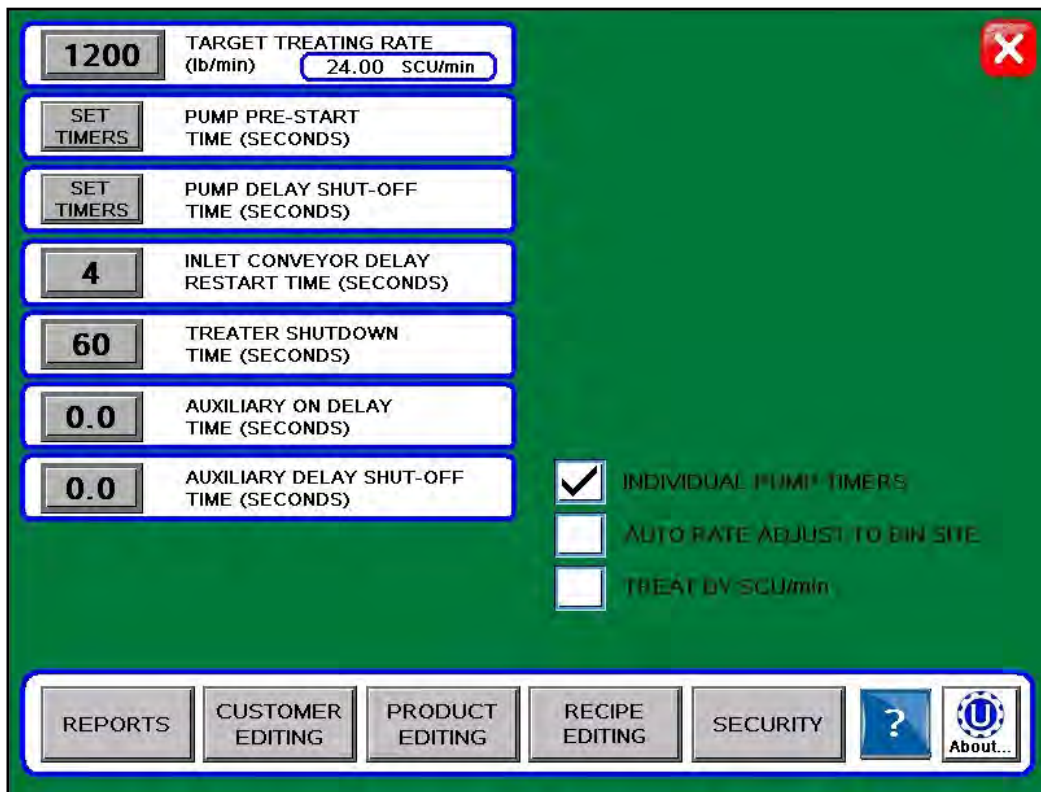

SEED FLOW CALIBRATION FOR TREATERS WITH SEED WHEELS

- Press the PRODUCT EDITING button. Select the product profile you want to calibrate on the left side of the screen from the list. The seed profile details will appear on the right where they may be edited and the seed wheel can be calibrated for that seed. Enter the weight of the seed sample in the Cup Weight box. The operator must press SAVE before leaving the profile if any changes were made. If they do not, the changes will not be added to that profile. The Calibrating Seed? popup is a reminder that large seed size variations of the same type of seed will require individual calibration.

If you are experiencing extreme seed size differences, even within the same seed type or variety, it is recommended to make multiple different seed profiles for each seed size. This will help the seed flow device (ex. seed wheel) calibrate more efficiently.

PRODUCT EDITING
Select the product you wish to rename and adjust that product's seeds per unit entry.

Product Profile List (Sorted)

< Enter Search Name >

CORN	▲
COTTON	▲
PEAS	▲
RICE	▲
SOYBEANS	▼
SOYBEANS - 2100	▼
SOYBEANS - 2200	▼
SOYBEANS - 2300	▼

Selection: 1 Viewing: 1 - 8 of 200
Total Used Records: 8

Profile Editing

Barcode: Seed Type 1
Name: CORN
Variety: ABCDEF
Lot Number: 123456
SEEDS/lb: 100
Seeds/Unit: 140000
Cups/Pocket: 2.52
Cup Weight (lb): 1.00

SEED WHEEL CALIBRATION CALCULATOR

SAVE CLEAR

Enter Seed Sample Weight Here

SEED FLOW CALIBRATION FOR TREATERS WITH LIW

1. Press the UTILITIES button on the main screen to advance to the utilities screen. Enter in the TARGET TREATING RATE in pounds per minute.

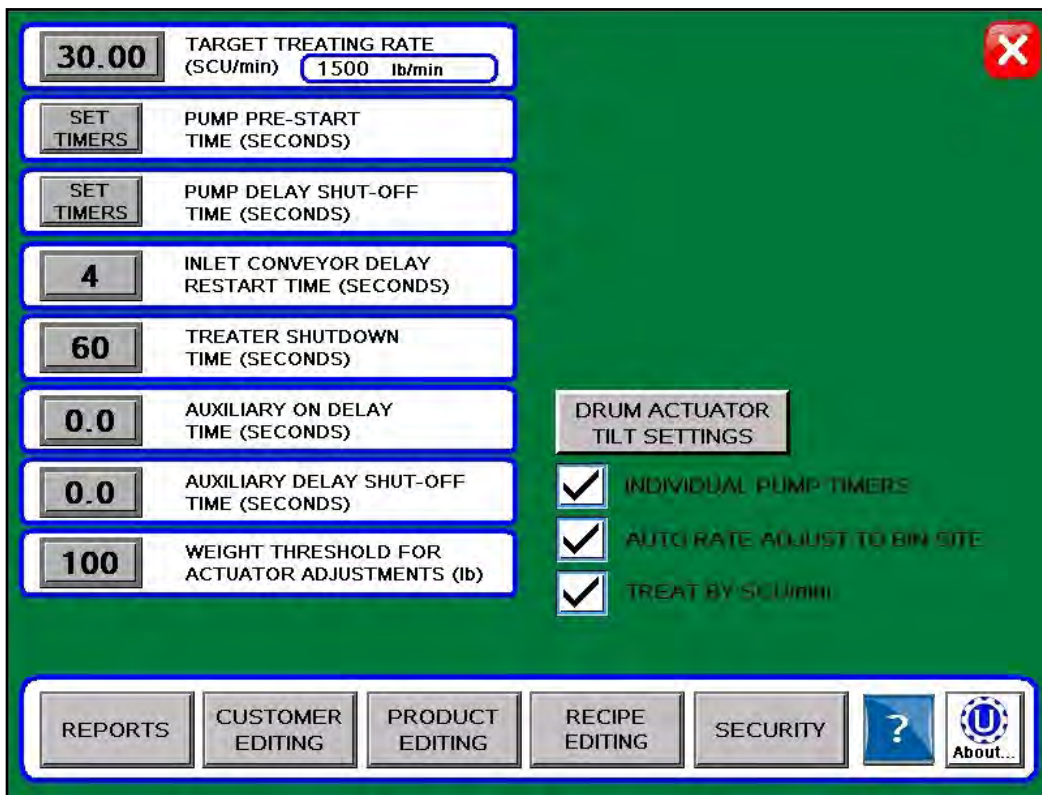

2. Press the PRODUCT EDITING button to advance to the product editing screen. Select the type of seed you will be treating on the left side of the screen from the list. The seed profile details will populate on the right where they may be edited and the seed actuator gate can be calibrated for that seed. The operator must press SAVE before leaving the profile if any changes were made or the changes will be lost and go back to what was previously set to that profile.
3. The Max Gate Position is a global variable and will be consistent between all product profiles. The operator may choose to have the Auto Calibration Ratio One-Shot button active, this does one calibration at the beginning of a run. If it is inactive, it updates each profile automatically throughout the running process for the active seed profile for more accuracy. Select the Set All Auto Calibration States to run all seed profiles in the automated mode.

SEED FLOW CALIBRATION FOR TREATERS WITH LIW

4. Setting Maximum Gate Position is important to set before running the treater so the system will not cause an alarm by asking the actuator to extend further than it physically can. To set this parameter be sure that there is no seed open to flow through the gate as it will open for several seconds as the warning popup will indicate. Once pressed and the warning confirmed the actuator gate will open to the maximum possible position and record the position in the program. Once set this should not need reset unless the hardware is moved for any reason. Again this will be the same on all product profiles.
5. Setting Minimum Gate Position is adjustable for every profile or may be set the same for every profile. If you have varying seed sizes it is suggested to set them for each profile. This setting indicates the lowest setting that seed will flow at. To set it for a certain seed you will need to have seed available in the buffer zone above the actuator gate. With the gate completely closed, go to the H-O-A screen and set the LIW ACTUATOR's Position setting to 5% and place the actuator in HAND mode. Then open the gate in small increments until a small but steady stream of seed is flowing out of the actuator. Note the Gate Position reading and place the actuator back in Auto mode of operation. Then, enter the noted gate position reading minus 200 into the Min Gate Position setting. This will allow the program to accurately calculate the seed flow through the actuator gate.

PUMP CALIBRATION

1. Lock down the pump tubing in the pump head.
2. Premix enough liquid for the amount of seed you are treating and pour into the chemical mix tank. It's always a good practice to mix enough extra slurry to help fill all the lines.
3. Press the manual start mix tank motor button on top of the pump stand. This will ensure that the chemical mixture within the mix tank is blended appropriately.
4. From the MAIN screen, select the chemical name box from the desired pump module and a selection window appears. Choose the type of chemical you will be applying. Press the TARGET RATE box below the chemical name on the main screen and you will be taken to the CHEMICAL EDITING screen. Select the RATE box next to the applicable chemical name and use the keypad to enter the value. Press the Save button. See CHEMICAL EDITING on page 28 for more detail.

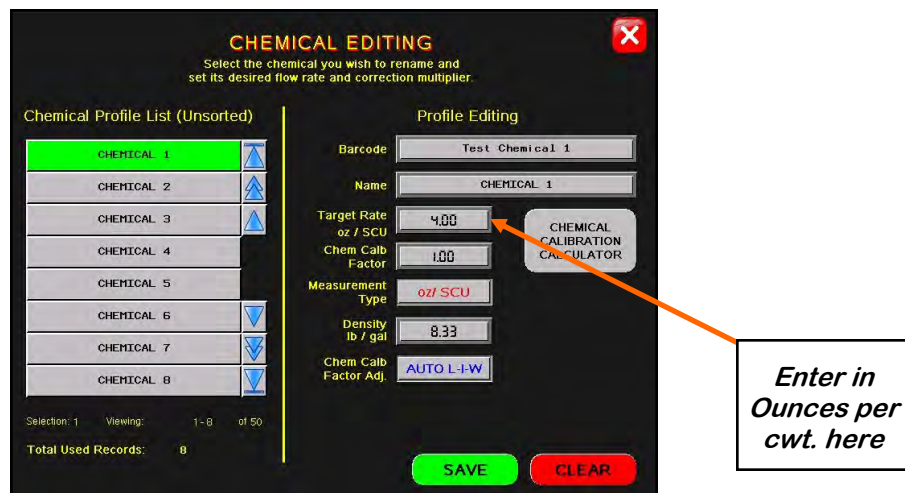
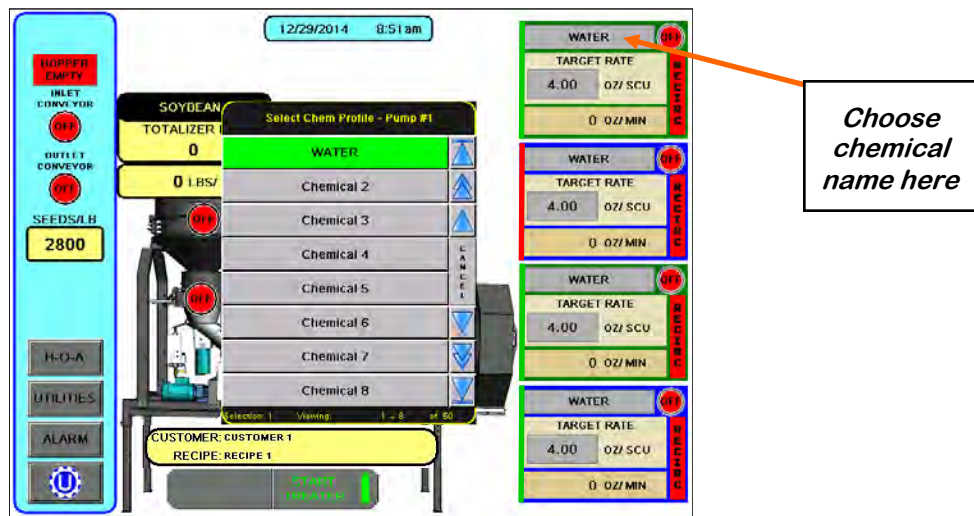

FLOW METER CALIBRATION

Due to the composition of some types of chemicals, additional flow meter calibration may be required. It is recommended that, like other calibration devices, the flow meter(s) is checked regularly and calibrated when needed. When calibrating the flow meter(s), each chemical slurry must be checked and adjusted for.

1. To begin the calibration process, fill the appropriate mix tank with the slurry that is going to be used for this calibration.
2. Turn the corresponding pump to the hand position and adjust the flow rate until it reads about 20 percent on the pump control module (top). Let the system run in recirculation mode for 15 minutes. This will remove any air from the system. Now place the pump in AUTO mode.

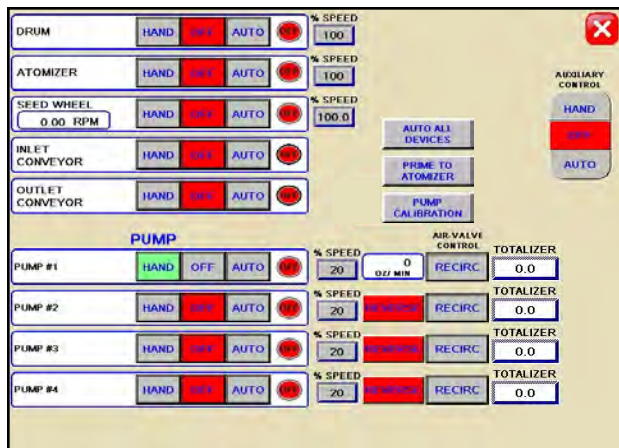

3. Place the MIX TANK/ CALIBRATION TUBE valve that is located on top of the pump stand in the calibration tube position.

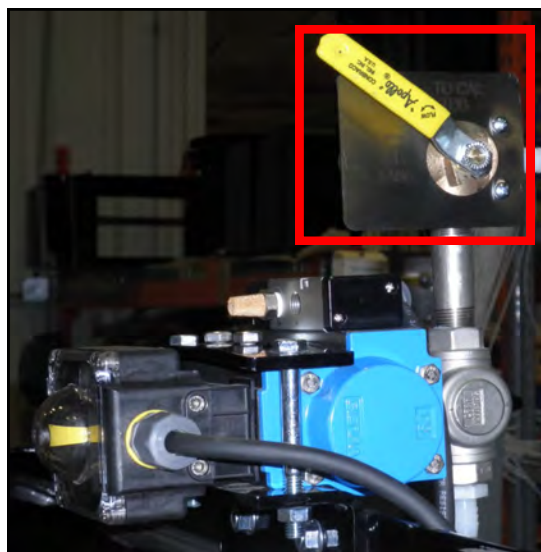

FLOW METER CALIBRATION

4. From the HOA screen, press the Pump Calibration button. Enter the number of the pump you wish to calibrate and a target run time for the calibration. The longer the run time the more accurate the calibration. USC recommends a minimum of 60 seconds. Press the jog pump motor, this will turn the pumps on and off for short periods of time. When the chemical lines are full and the level in the tube is at zero, press the button again to stop the pump. Press the START button to begin the calibration. When the target run time has elapsed, the pump will shutoff automatically. If for any reason you need to stop the process, press the STOP button. If the calibration is stopped before the target time has elapsed, the operator must start the process over again. Enter the calibration tube ounces into the Cal. Tube Total box. Enter the flow meter reading into the Calculated Totalizer box. Press the UPDATE RATIO button and it will automatically update. Closing this screen will stop the calibration process if it has not been completed.
5. Repeat the process as necessary and for each different chemical slurry used.

PUMP CALIBRATION CALCULATOR

Pump # to Adjust:
 Selected Pump's Chemical Name:

Target Run Time (Seconds):
 Actual Rate (mL / min):

Target Rate (mL / min):

Rough Est. Total (mL):

TOTALS:

Cal. Tube Total mL

Calculated Totalizer mL

Elapsed Run Time (Seconds): seconds

CALIBRATION RATIO:

Current Ratio:

Calculated Ratio:

LOSS IN WEIGHT FLOW CALIBRATION

Due to the composition of some types of chemicals, additional flow meter calibration may be required. It is recommended that, like other calibration devices, the flow meter(s) is checked regularly and calibrated when needed. When calibrating the flow meter(s), each chemical slurry must be checked and adjusted for.

1. To begin the calibration process, fill the appropriate mix tank with the slurry that is going to be used for this calibration.
2. Turn the corresponding pump to the hand position and adjust the flow rate until it reads about 20 percent on the pump control module (top). Let the system run in recirculation mode for 15 minutes. This will remove any air from the system. Now place the pump in AUTO mode.

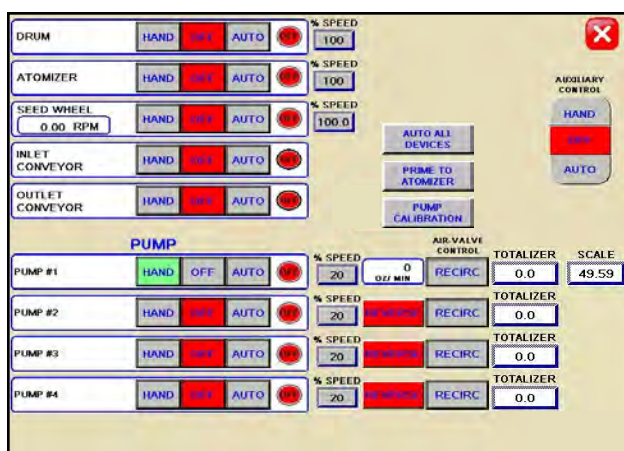

3. Place the MIX TANK/ CALIBRATION TUBE valve that is located on top of the pump stand to the calibration tube position.



LOSS IN WEIGHT FLOW CALIBRATION

4. From the HOA screen, press the Pump Calibration button. Enter the number of the pump you wish to calibrate and a target run time for the calibration. The longer the run time the more accurate the calibration. USC recommends a minimum of 60 seconds. Press the jog pump motor, this will turn the pumps on and off for short periods of time. When the chemical lines are full and the level in the tube is at zero, press the button again to stop the pump. Press the START button to begin the calibration. When the target run time has elapsed, the pump will shutoff automatically. If for any reason you need to stop the process, press the STOP button. If the calibration is stopped before the target time has elapsed, the operator must start the process over again. Enter the calibration tube ounces into the Cal. Tube Total box. Press the UPDATE DENSITY button and it will automatically update. Closing this screen will stop the calibration process if it has not been completed.
5. Repeat the process as necessary and for each different chemical slurry used.

LOSS IN WEIGHT SCALE CALIBRATION

NOTICE

During the weight transmitter setup and calibration process it will be necessary to enter the operational parameters using the 201 keypad. See figure 1.

AVIS

Pendant le processus d'installation de l'émetteur de poids et de l'étalonnage, il sera nécessaire d'entrer les paramètres de fonctionnement en utilisant le clavier 201. Voir la figure 1.

! WARNING

DO NOT operate the keypad with pointed objects (pencils, pens, etc). Damage to the keypad resulting from this practice is **NOT** covered under warranty.

! AVERTISSEMENT

NE PAS utiliser le clavier avec des objets pointus (crayons, stylos, etc.). Dommages au clavier résultant de cette pratique ne soit pas couvert par la garantie.

CARDINAL 201 SCALE HEAD DATA ENTRY

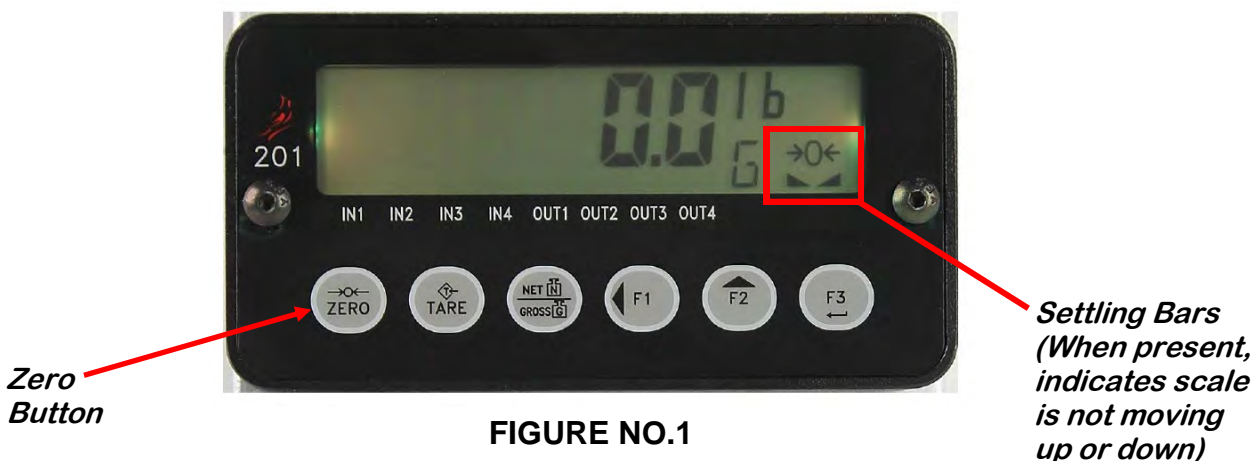

FIGURE NO.1

- The function of the numeric keys are replaced by using the **F1/◀** and the **F2/▲** Keys.
- The cursor location is identified by the blinking character and may be moved to the left to the next position by pressing the **F1/◀**.
- Pressing the **F2/▲** key will change the blinking character to the next value or setting. Continue to press this key to toggle between the different available values or settings for the setup parameter.
- Pressing the **F1/◀** key when a setup parameter (not a parameter value or setting) is displayed, will backup to the previous parameter prompt.
- Pressing the **F3/←** key will save the data entered or displayed and advance the screen to the next prompt.

CALIBRATION SWITCH

CAUTION

USE CAUTION WHEN WORKING INSIDE THE ENERGIZED PANEL!!

! ATTENTION

PRUDENCE LORS DE TRAVAIL DANS LA PANEL ENERGIZED !!

NOTICE

USC recommends that the pump stand scales be calibrated at least once at the start of each treating season.

AVIS

USC recommande que les échelles de supporter la pompe être étalonnés au moins une fois au début de chaque saison de

NOTICE

USC recommends that the pump stand scales be zeroed out before each calibration (see figure 1).

1. Make sure there is nothing on the scale.
2. Settling Bars must be present on the scale head display.
3. Press the Zero button on the scale head display.

AVIS

USC recommande que l'échelle du peuplement de la pompe être mis à zéro avant chaque étalonnage (voir figure 1).

1. Assurez-vous qu'il n'y a rien sur l'échelle.
2. Bars de décantation doit être présent sur l'affichage de l'échelle.
3. Appuyez sur la touche zéro sur l'affichage de l'échelle.

The model 201 weight transmitter has been thoroughly tested and calibrated before being shipped to you. If you received the weight transmitter attached to a scale, calibration is not necessary. If the weight transmitter is being connected to the scale for the first time or recalibration is necessary for other reasons, continue following these instructions.

The calibration switch is located on the main printed circuit board and may only be accessed by removing the screw below and to the right of the load cell connector. See figure 2.

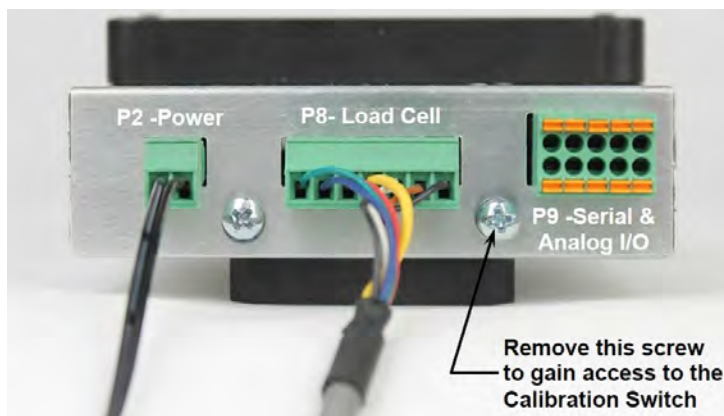

FIGURE NO.2

ACCESSING SETUP

1. With the screw removed to gain access to the calibration switch, apply power to the 201 Weight Transmitter.
2. Insert a small tool (3/32 or 2mm Hex Key Wrench) into the hole where the screw was removed until it contacts the calibration switch.
3. Press and hold the calibration switch for approximately 2 seconds until the display changes to SEtUP.
4. Release the calibration switch to begin setup.
5. Press the **F2/▲** key to step to the beginning point of each setup section.

SEtUP	Setup Mode (starts at <i>USR =</i> prompt)
SCALE	Scale Configuration (starts at <i>Unit =</i> prompt)
F ILTERR	Analog to Digital Filtering (starts at <i>FLt =</i> prompt)
CAL	Calibration (starts at <i>CAL =</i> prompt)
F SPAN	Fine Span Adjustment

6. If you press the **F3/←** key at the SETUP prompt, you may proceed through the next section (up to and including F SPAn) by pressing the **F3/←** key.

CALIBRATION

- With CAL displayed, press the **F3/←** key. The display will change to CAL=. Proceed to the CAL= (Perform Calibration) parameter.
- CAL = (Perform Calibration)
 - With CAL= displayed, press the **F3/←** key. The display will change to no. If the scale has been previously calibrated and you wish to skip the calibration to proceed to F SPAn, press the **F3/←** key again.
 - Otherwise, press the **F2/▲** key to toggle to YES and then press the **F3/←** key. The display will change to CAL 1=. Proceed to the CAL 1= parameter.

SINGLE POINT CALIBRATION

- CAL 1 = - First Calibration Weight
 1. The display will show CAL 1 =. This is the first of two calibration weights. This weight is ZERO (NO LOAD).
 2. Press the **F3/←** key to view the current setting.
 3. Press the **F3/←** key again to set absolute zero.
 4. Starting at the left and proceeding right, a series of dashes will appear and then disappear. Then the display will show CAL 2=.
- CAL 2 = - Second Calibration Weight
 1. The display will show CAL 2 =. This is the second of two calibration weights. This weight is with the two 50lb. test weights. (TEST LOAD).
 2. Press the **F3/←** key to view the current setting.
 3. Use the **F1/◀** and **F2/▲** to input the value of the test weights. The display must read 100.000.
 4. Place both 50lb. weights on the scale platform, then press the **F3/←** key.
 5. Starting at the left and proceeding right, a series of dashes will appear and then disappear. Then the display will show F SPAn.
 6. The calibration process is now complete. Press **F1/◀** until you are returned to the starting screen.

NOTICE

- For a single additional scale LIW Upgrade Kits, Order USC Part # 13-05-0444.
- LIW Add-on Panels will only support up to 4 pumps per panel. A 2 Pump LIW Add-on Panel can only have two 1 Pump Upgrade Kits installed. If more than 4 pumps, additional LIW Add-on Panels must be purchased.

AVIS

- Pour un seul Kits LIW échelle de mise à niveau supplémentaires, # Ordre USC Partie 13-05-0444.
- LIW Add-on ne fera que les panneaux en charge jusqu'à 4 pompes par panneau. A 2 Pompe LIW Add-on Panel ne peut avoir deux 1 Pompe de mise à niveau Kits installés. Si plus de 4 pompes, supplémentaires LIW Add-on Les panneaux doivent être achetés.

SEED WHEEL CALIBRATION

1. If the totalized weight from the seed wheel differs from the actual weight of the seed that was run through the treater. The seed wheel may be calibrated to increase accuracy. Press the Utilities button on the Main screen. Press the PRODUCT EDITING button, here you will choose the product and press the SEED WHEEL CALIBRATION button (top). This will advance you to the Seed Wheel Calibration screen (bottom).
2. Enter in the ACTUAL SCALE WEIGHT of the seed that was treated, and the TOTALIZER WEIGHT from what the seed wheel recorded.
3. Press the APPLY button. The PLC will automatically calibrate the seed wheel and exit back to the main screen.



Note: The seed wheel calibration screen will adjust the seed profiles Cups / Pocket Ratio automatically.

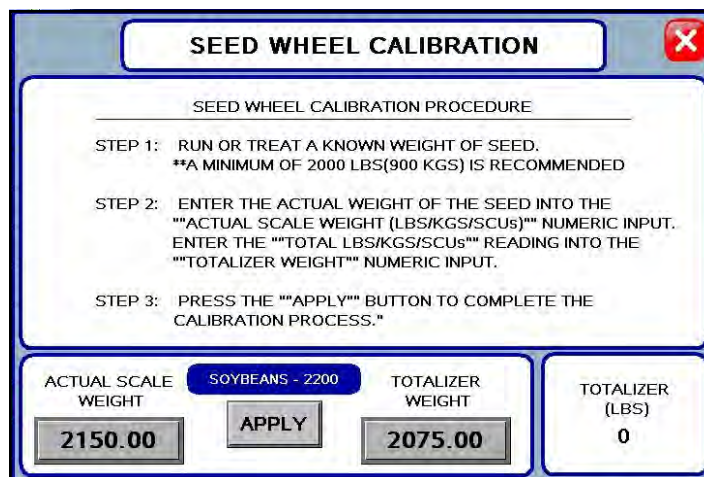

TREATING SEED WITH SEED WHEEL

1. From the treater H-O-A screen, press the AUTO ALL DEVICES button to place the Drum, Atomizer, Seed Wheel, Inlet Conveyor and Outlet Conveyor and the desired pumps in AUTO.
2. Next, prime the chemical line to the atomizer. Ensure that the valve on each of the chemical attachment ports on the treater are in the correct position. Then, press and hold the PRIME TO ATOMIZER button. The atomizer will turn on and liquid will begin pumping up to the atomizer. When liquid reaches the atomizer release the PRIME TO ATOMIZER button.

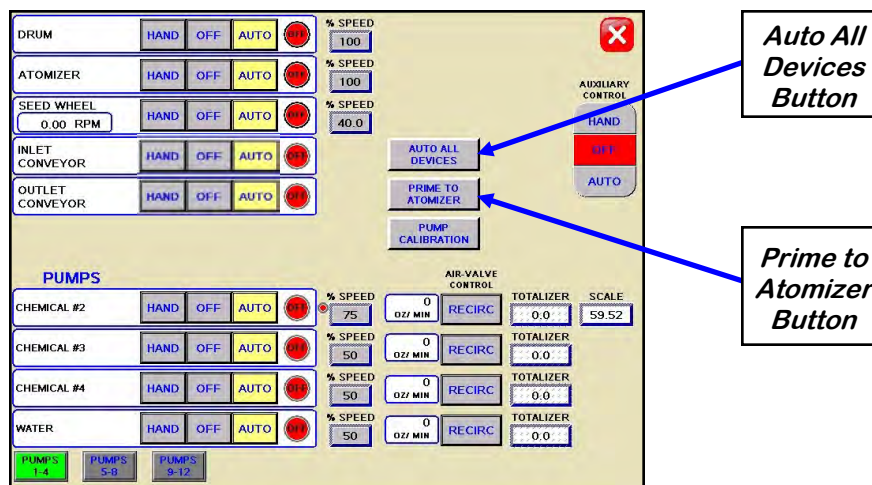

3. Return to the main screen and press the START button. The startup screen appears. Press the gray buttons to change any fields such as customer, seed type and actual weight for this run. Press START to begin the run. The drum, atomizer, inlet conveyor and outlet conveyor will activate. The pump will turn on and re-circulate until it reaches the desired flow rate needed to match the target treating rate that was entered. The inlet conveyor will then begin dumping seed into the seed wheel.

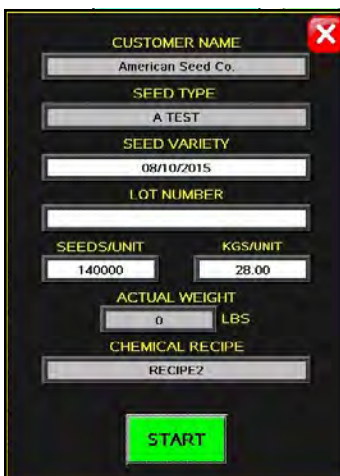

TREATING SEED WITH SEED WHEEL

4. When the pump's flow rate has been reached and seed is covering the proximity sensors inside of the seed wheel, the air actuated 3-way valve will open and allow liquid to pump up to the atomizer. A moment later (based on the settings in the utilities screen), the seed wheel will turn on and the seed treating process will begin.
5. As the seed is being treated, the main screen will display the pounds per minute, the total pounds, and the liquid flow rate. If the system needs to be stopped for a moment because of a problem. The PAUSE button can be pressed to halt the process. When ready to begin again, the CONTINUE button is pressed.
6. When the seed wheel hopper is full the HOPPER FULL indicator light will come on and the inlet conveyor will shut off. The flow of seed into the hopper will begin again once seed is no longer present at the top proximity sensor in the hopper and the Inlet Conveyor Delay Restart time defined on the utilities has expired. This is done to ensure that seed will not overflow the hopper and flow onto the ground.
7. When all seed passes through the seed wheel, the seed wheel will turn off and the pump will switch to re-circulate. When more seed is fed into the treater, the treating process will continue.
8. After all seed has been treated the seed wheel will shutdown automatically. The 3-way valve on the pump stand will switch to re-circulate. However, the atomizer, drum and outlet conveyor will still be running. Press the SHUTDOWN button at the bottom of the screen and the shutdown timer appears and begins to count down the seconds left before complete shutdown. The operator decides how much time is adequate for all product to clear the drum and outlet conveyor. The time is entered on the utilities screen and may be adjusted whenever necessary.

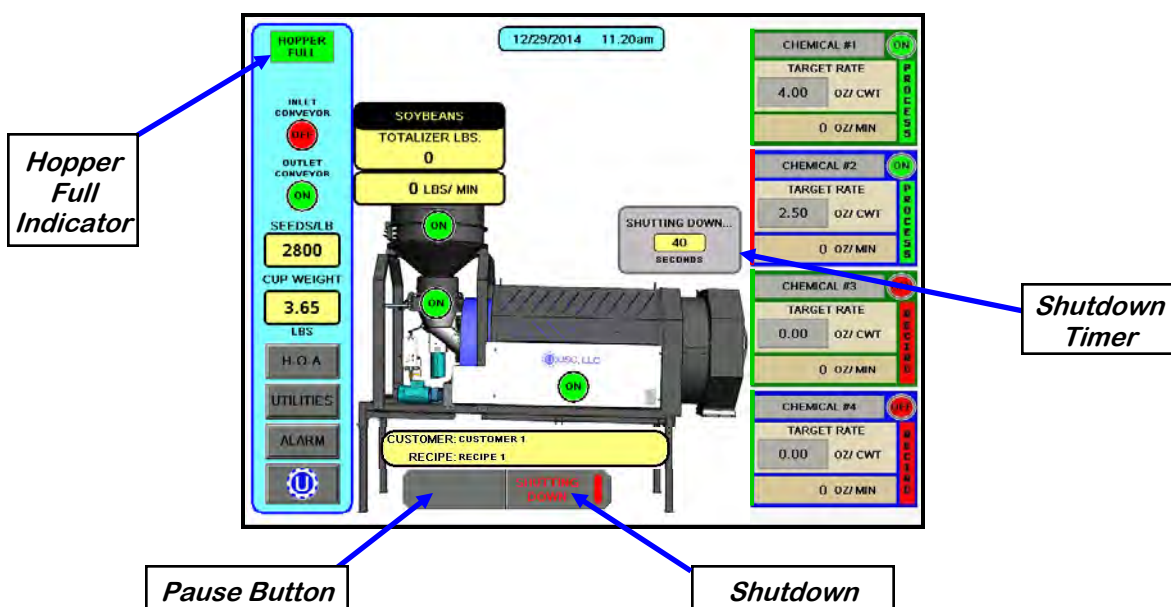

TREATING SEED WITH LOSS - IN - WEIGHT

1. From the treater H-O-A screen, press the AUTO ALL DEVICES button to place the Drum, Atomizer, LIW Actuator, Inlet Conveyor, Outlet Conveyor, and the desired pumps in AUTO.
2. Next, prime the chemical line to the atomizer. Ensure that the valve on each of the chemical attachment ports on the treater are in the correct position. Then, press and hold the PRIME TO ATOMIZER button. The atomizer will turn on and liquid will begin pumping up to the atomizer. When liquid reaches the atomizer release the PRIME TO ATOMIZER button.

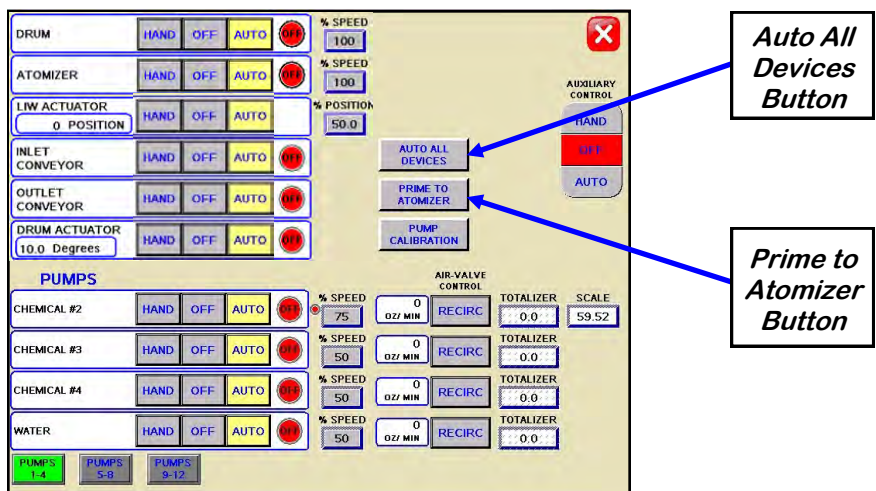

3. Return to the main screen and press the START button. The startup screen appears. Press the gray buttons to change any fields such as customer, seed type and actual weight for this run. Press START to begin the run. The drum, atomizer, and outlet conveyor will activate. The pump will turn on and re-circulate until it reaches the desired flow rate needed to match the target treating rate that was entered.



TREATING SEED WITH LOSS - IN - WEIGHT

4. When the pump's flow rate has been reached and seed is covering the proximity sensors inside of the hopper cone, the air actuated 3-way valve will open and allow liquid to pump up to the atomizer. A moment later (based on the settings in the utilities screen), the Loss in Weight actuator will turn on and the seed treating process will begin.
5. As the seed is being treated, the main screen will display the pounds per minute, the total pounds, and the liquid flow rate. If the system needs to be stopped for a moment because of a problem. The PAUSE button can be pressed to halt the process. When ready to begin again, the CONTINUE button is pressed.
6. When all seed passes through the hopper, the pump will switch to re-circulate. When more seed is fed into the treater, the treating process will continue.
7. After all seed has been treated the 3-way valve on the pump stand will switch to re-circulate. However, the atomizer, drum and outlet conveyor will still be running. Press the SHUTDOWN button at the bottom of the screen and the shutdown timer appears and begins to count down the seconds left before complete shutdown. The operator decides how much time is adequate for all product to clear the drum and outlet conveyor. The time is entered on the utilities screen and can be adjusted whenever necessary.

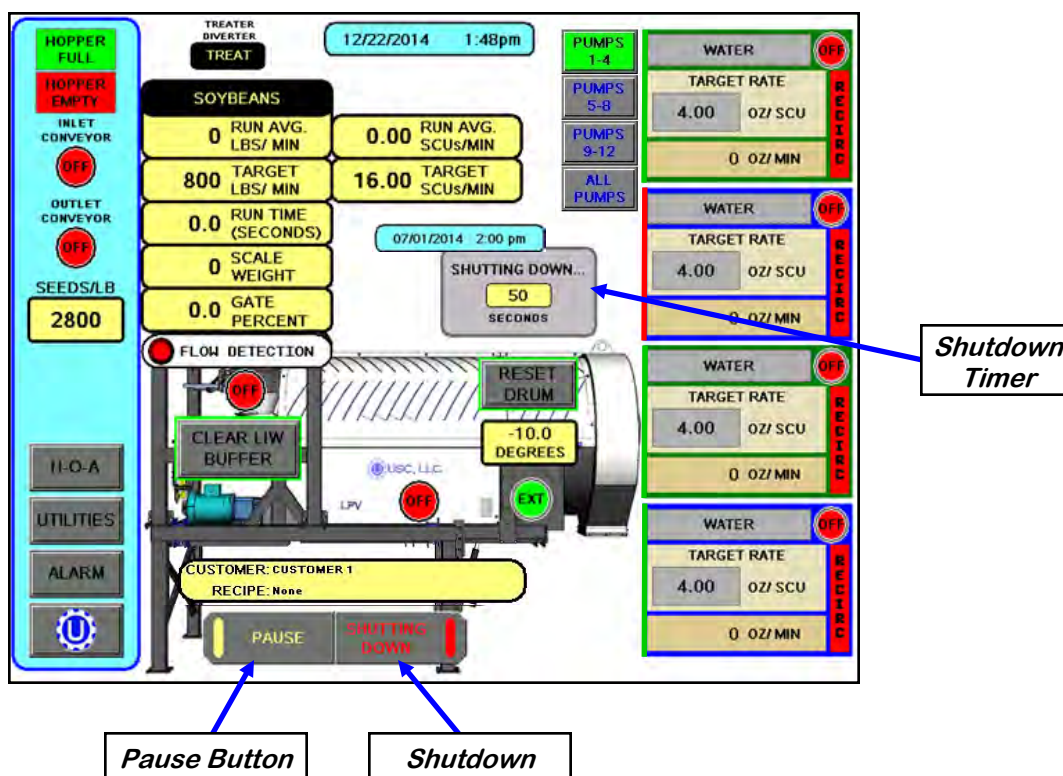

SECTION
D-3**BATCH HOPPER CALIBRATION &
OPERATION****LOADING SEED INTO BINS**

Before seed is pulled out of the bins and run through the batch hopper system, all the applicable information about the seed that was loaded into each individual bin must first be entered into the batch hopper system. If the same seed was loaded into multiple bins the same information still needs to be loaded into each bin separately.

The following is a list of steps to perform to enter the bin information for each bin once seed has been loaded into that bin:

1. Load the seed into the bin. Take a seed sample for the cup weight of each bin at this time. Also, note the seed type, seed variety, lot number, seed weight and total inventory weight of the seed that is loaded into the bin. The seed weight may be defined in either pounds, seed count units or seed weight units.
2. Press the UTILITIES button in the lower left corner of the Bin Site main screen.
3. Press the SECURITY button on the bottom of the Utilities screen.
4. Press the PASSWORD box, then from the popup keyboard enter the letters USC and press enter.
5. Press the TOOLS & OPTIONS button in the lower left hand corner of the Security screen.
6. Press the BIN EDITING button on the Tools & Options screen.

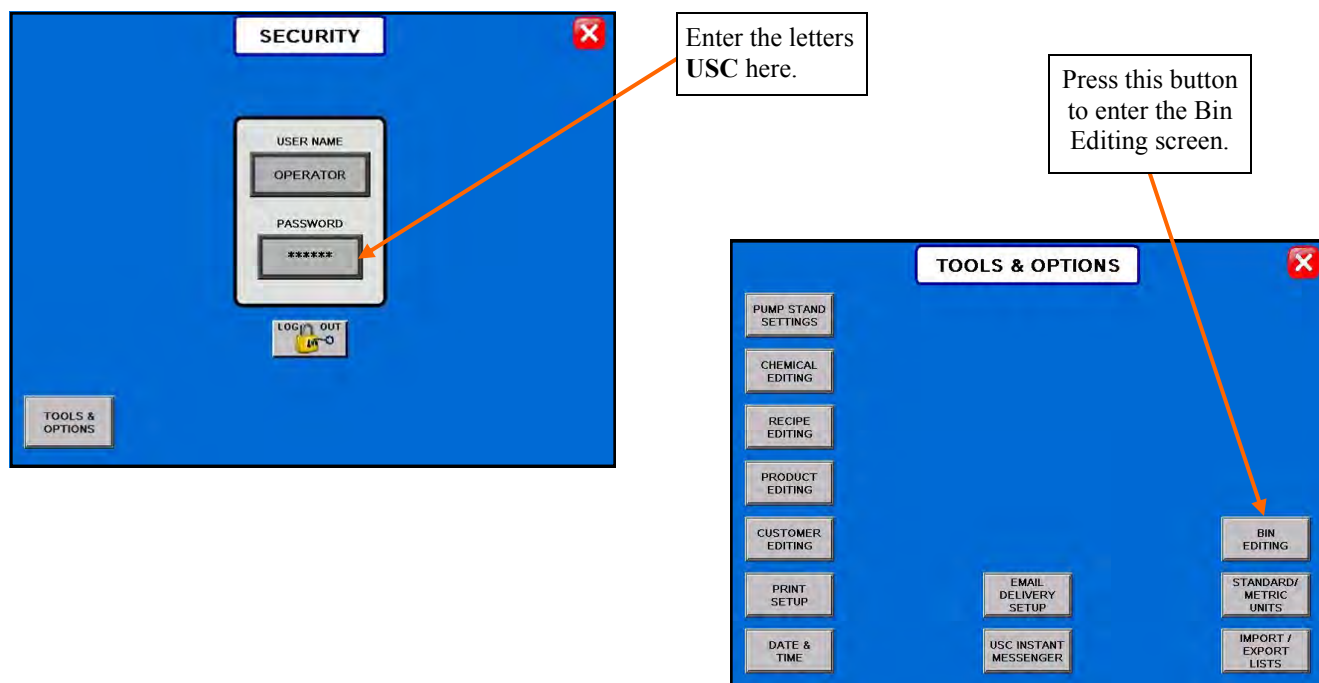

LOADING SEED INTO BINS

7. Select the desired bin to enter information into from the select bin list..
8. Enter the seed type, seed variety, lot number, seeds per pound and cup weight of the seed in the bin into their respective box under the Current Bin Info.
9. Enter in the total weight of seed that was added to the bin into the bin inventory section on the lower portion of the screen. The system will automatically subtract inventory after each run. Press the save button when all the information has been entered.
10. When finished, exit back to the Main screen.



SETTING THE SEED FLOW RATE

The following is a list of steps for setting the seed flow rate. This must be completed before running the batch hopper system. Repeat steps 1 & 2 for each bin.

1. Set the manual gate on the bin to the fully open position. Once opened, this gate should be set in place and not moved throughout the entire season. If this gate is adjusted during a run or between runs then it will affect the calibration of the system and the system will need to be re-calibrated (page 98).
2. Set the stop for the air actuated slide gate on the bin. This stop controls how far the slide gate will open and the flow rate at which seed can exit the bin. To set the stop, adjust the position of the collar on the rod that exits the slide gate opposite of the air valve (see page 113). Placing the collar closer to the slide gate will restrict flow and farther away from the slide gate will increase seed flow for the system. Once a collar location has been selected, use the hitch pin to lock the collar in place. If the stop is adjusted between runs then it will affect the calibration of the system and the system will need to be re-calibrated (page 98).

NOTICE

It is recommended to initially place the collar closer to the slide gate and then move it farther away from the slide gate one hole at a time to increase the flow rate of the system. This will protect against overloading the underbin conveyor with seed.

AVIS

Il est recommandé de placer d'abord le col plus proche de la valve à tiroir et le déplacer plus loin de la porte coulissante un trou à la fois pour augmenter la vitesse du système d'écoulement. Cela permettra de protéger contre la surcharge du convoyeur underbin avec des semences.

3. Finally, set the position of the manual slide gate that is located under the weigh hopper. This gate will control the flow of seed out of the weigh hopper by restricting the size of the opening from the weigh hopper. The more open the gate is, the faster seed will exit the weigh hopper. To set this gate, simply loosen the three nuts on the gate. Then adjust the gate to the desired position, and retighten the nuts.

SETTING THE SEED FLOW RATE

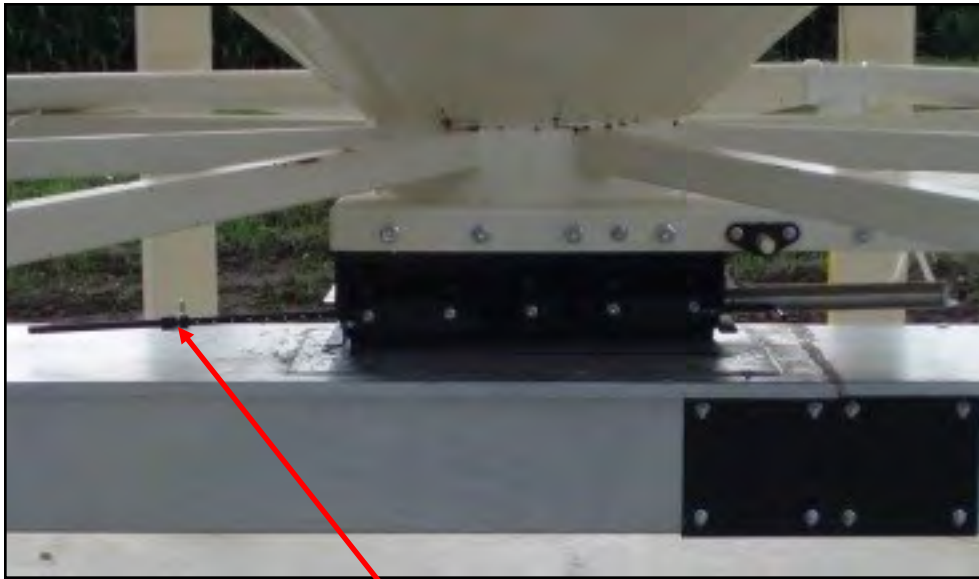

Move the position of the collar along this rod to adjust the flow of seed through the bin slide gate.

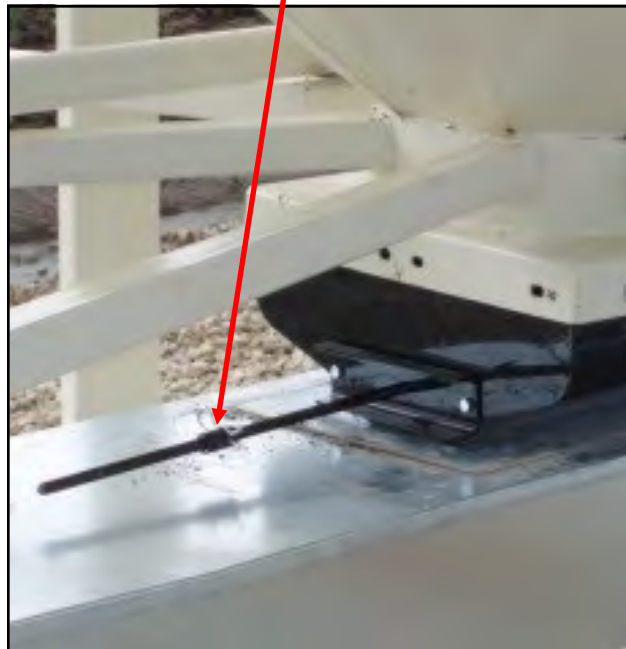

SCALE FILL FROM BIN

The following is a list of steps to use when running the batch hopper system in the Scale Fill From Bin mode of operation. This allows the operator to automatically fill the scale from the bin.

1. Under the H-O-A screen place all necessary conveyors into the AUTO mode of operation. (below left) Ensure that the diverter is in the appropriate position as well.
2. Under the Utilities screen, ensure that all settings are correct (below right).

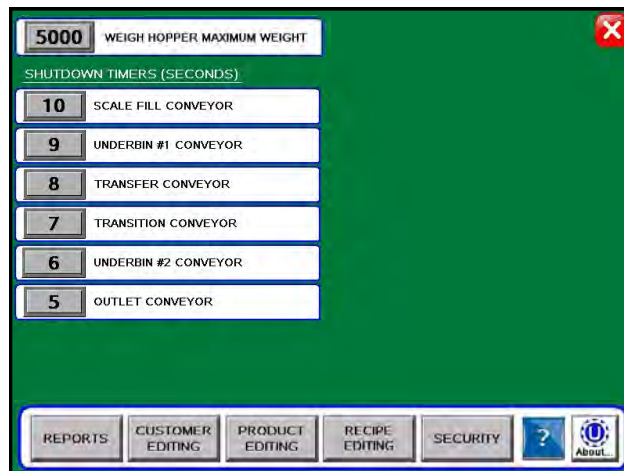
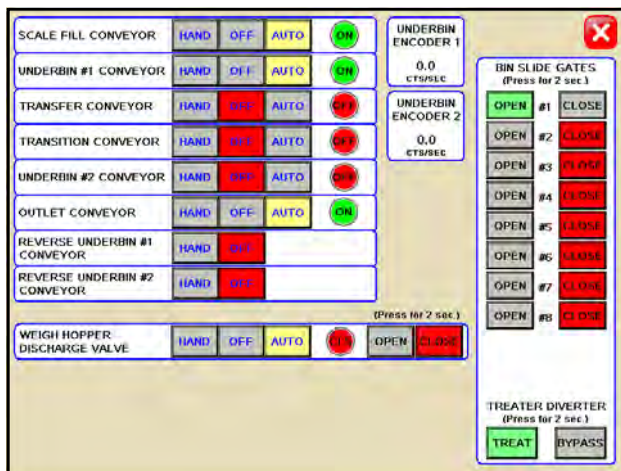

3. Press the START BIN SITE SETUP button on the Main screen.
4. Press the CUSTOMER button at the top of the setup screen and enter in the current customer's name in the search box or scroll through the rolodex with the navigation buttons.
5. Press the SELECTED BIN button and select the bin you want to pull seed from.
6. Press the TARGET WEIGHT button and enter the amount of weight that is to be brought into the batch hopper on this run.
7. Press the SEED OUTLET PATH button and then select either AUTO TREAT or MANUAL TREAT mode of operation depending upon what you plan to do with the seed once it has been pulled from the bin and weighed by the batch hopper system. There may be other names set for different outlet paths an operator may see based on different configuration settings.

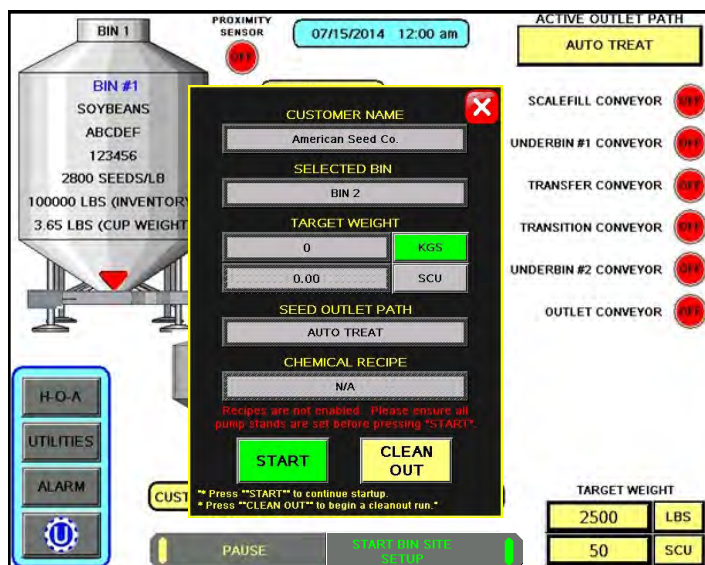

SCALE FILL FROM BIN

8. If the enable recipe controls are active on the recipe screen (see page 29), the CHEMICAL RECIPE button will be active and you may select one from this screen.
9. Press the START button at the bottom of the startup screen. This toggles the button to CANCEL SCALE FILL FROM BIN and activates the PAUSE button. The system will first turn on the scale fill conveyor and then the underbin conveyor. Once all needed conveyors are running, the slide gate for the selected bin will open and seed will flow through the conveyors to the batch hopper. Once all needed conveyors are running, the slide gate for the selected bin will open and seed will flow through the conveyors to the batch hopper.
10. As the batch hopper system is running, the main screen will display the total pounds of seed in the weight hopper, and the status of the conveyor motors.
11. The slide gate on the bin will automatically close once the target weight in seed passes through the slide gate. Once the gate closes, a window will appear notifying the operator that the batch is finishing. It will then be replaced with another window indicating amount of time before the system shuts down. If operating in the Manual Treat mode the treater will have to be turned on and off separately. The system will then shutdown the conveyors in reverse order of startup. This will ensure the conveyors have an opportunity to clean out any product from them. (bottom)

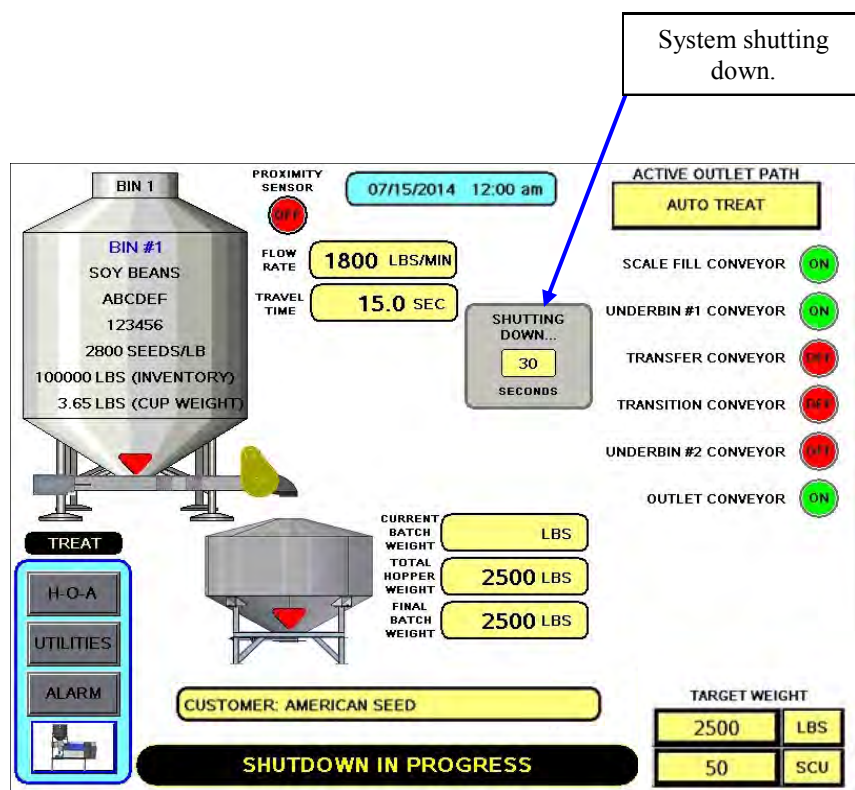

CALLING IN SEED FROM PRO BOXES

The following is a list of steps to use when running the batch hopper system in the Scale Fill From Manual Hopper mode of operation. This allows the operator to automatically fill the scale from Pro Box.

1. Under the H-O-A screen place all necessary conveyors into the AUTO mode of operation. Depending upon the setup of the equipment, some bin sites will require only the transfer conveyor or the scale fill conveyor to be in AUTO mode and some sites will require the transfer, underbin and scale fill conveyors to all be in the AUTO mode. Ensure that the diverter is in the appropriate position as well.
2. Under the Utilities screen, ensure that all settings are appropriate.
3. Press the START BIN SITE SETUP button on the Main screen.

4. Press the CUSTOMER button at the top of the setup screen and enter in the current customer's name in the search box or scroll through the rolodex with the navigation buttons.

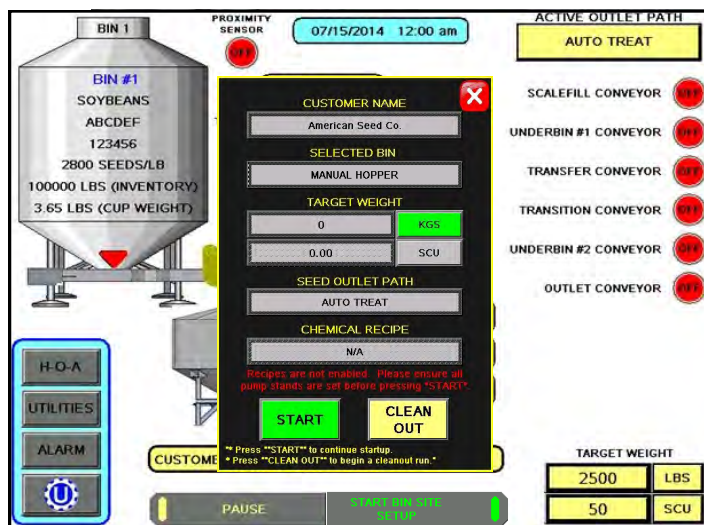

5. Press the SEED OUTLET PATH button, then select either AUTO TREAT or MANUAL TREAT mode of operation depending upon what you plan to do with the seed once it has been pulled from the Pro Box and weighed by the batch hopper system. There may be other names set for different outlet paths an operator may see based on different configuration settings.

6. Press the SELECTED BIN button and select the Manual Hopper.

7. From the MANUAL HOPPER screen, enter the seed type, seed variety, lot number, seeds per unit of measurement and cup weight for the seed.

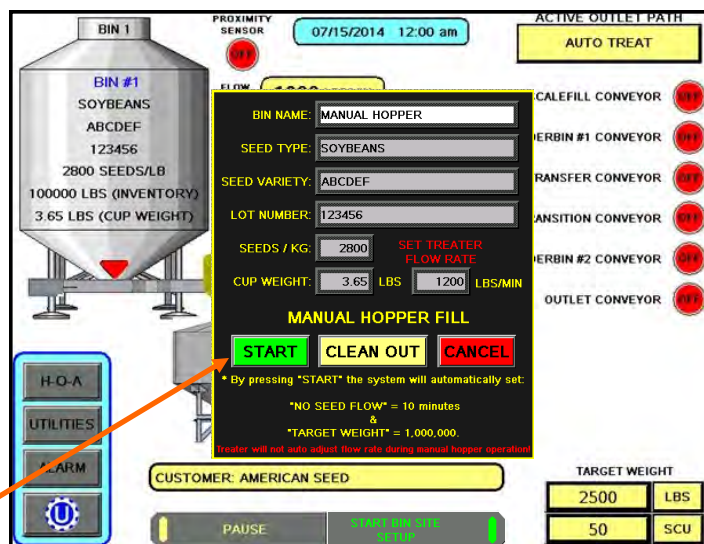

Start

CALLING IN SEED FROM PRO BOXES

8. Once all seed information has been entered, press START. This toggles the button to FINISH SCALE FILL FROM HOPPER and activates the PAUSE button. The system will first turn on the scale fill conveyor, the underbin conveyor, then the transfer conveyor (If applicable) and the outlet conveyor (If applicable).
9. As the batch hopper system is running, the main screen will display the total pounds of seed in the weigh hopper. If the system needs to be stopped for a moment because of a problem, the PAUSE button may be pressed to halt the process. When ready to begin again, press the CONTINUE button.
10. Once all of the seed has passed from the manual hopper, through the conveyors and through the weigh hoppers, press the FINISH SCALE FILL FROM HOPPER button. At this point, the conveyors will shutdown in reverse order of startup.
11. The system will automatically print the report for the run from the scale head printer.

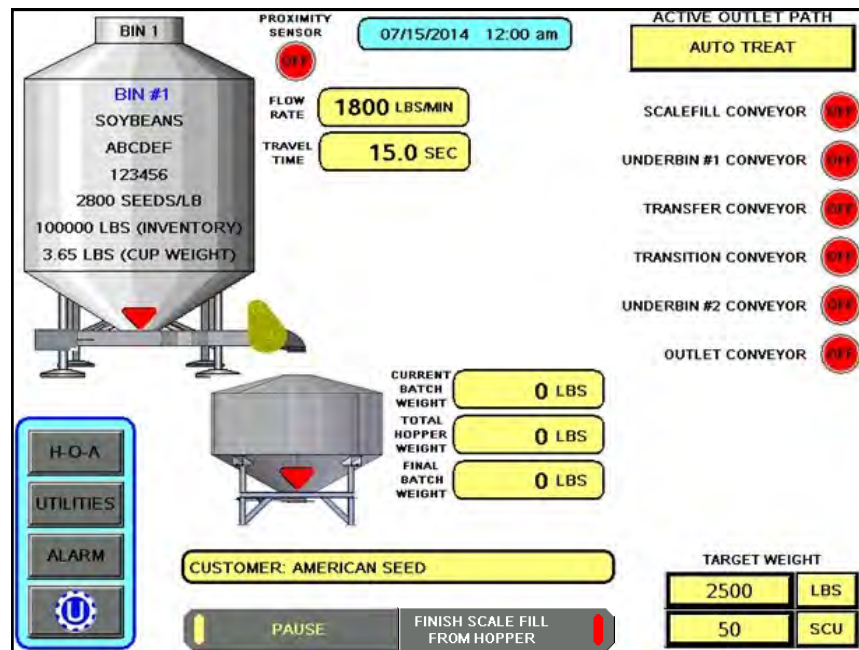

BATCH HOPPER CALIBRATION

Once the initial calibration is established, the system continuously updates the seed flow rate. The calibration is based upon time and weight. The system first calculates the amount of time it takes for the seed to travel from the bin slide gate to the weigh hopper. This is called the travel time. Then the system calculates how long it takes to fill the weigh hopper. This allows the system to calculate the seed flow rate of pounds per minute. Finally, the system uses the travel time and seed flow rate to calculate the amount of seed in the conveyors at any given time. Once this weight is known, it will automatically close the bin gate at the appropriate time to reach the target weight of seed that the operator has entered.

Initial calibration procedure:

1. Set the bin collar in the fourth hole from the end of the rod in. This sets the Flow Rate at approximately 1200 pounds. Adjust as needed (each hole adjusts up or down by approximately 200 pounds). These figures are based on Soybeans.
2. From the main screen check the Flow Rate to verify it is at the default setting of 1800 lbs/min and the Travel Time is at its default of 15.0 sec. Then set your Target Weight at 2000 pounds. This Target Weight is recommended but not necessary depending on the setup. After the run, check to see if the Flow Rate and Travel Time have changed from the default settings. If they have the system has been successfully calibrated. Each bin must be individually calibrated. As long as there have been no pauses or alarms the system will re-calculate and update the flow rate display after the run is complete. For the Travel Time to update, there must be seed in the hopper before the bin slide gate closes

NOTE: If you change the location of the bin collar or the bin runs out of seed before the Target Weight is reached the system will need to be re-calibrated.

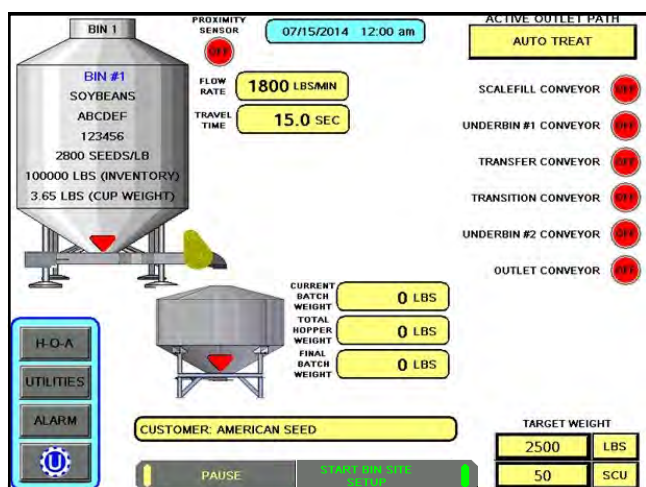

UNDERBIN OPERATION IN REVERSE MODE

The following is a list of steps to use when running the batch hopper system using the REVERSE mode. This mode of operation will allow the operator to clean out the underbin conveyor and to remove any excess seed from the bins at the end of the treating season. **ALWAYS ENSURE THE BELT IS IMMEDIATELY AND PROPERLY ALIGNED WHEN RUNNING IN REVERSE! BELTS WILL OFTEN SHIFT ALIGNMENT WHEN THEIR DIRECTION OF TRAVEL IS REVERSED.**

The reverse option for the underbin conveyor will only be present if the controls for this feature have been installed.

1. Place a conveyor and seed storage container under the reversing end of the underbin conveyor to catch seed as it exits the underbin conveyor. Turn that conveyor motor on.
2. Under the H-O-A screen place the REVERSE UNDERBIN CONVEYOR operation in the HAND mode. (top) Ensure that the belt on the underbin conveyor is correctly aligned.

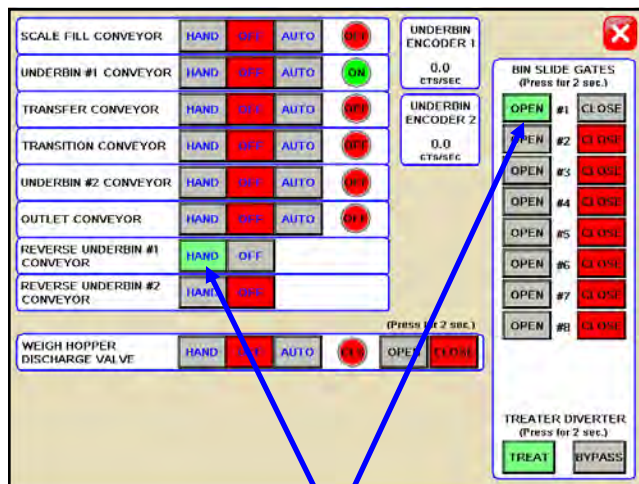

Press the HAND button and then place the bin slide gate to the OPEN position.

3. Then, manually place the desired bin slide gate to the OPEN position. (top)
4. The batch hopper main screen will show the underbin conveyor on and the bin slide gate in the open position (bottom).

5. Once all seed has passed through the underbin conveyor and into the seed container, place the open bin slide gate back to the CLOSED position.
6. Allow the underbin conveyor to run for at least 15 seconds. This will allow the underbin conveyor to clean itself out. Then place the underbin conveyor motor back to the OFF position.

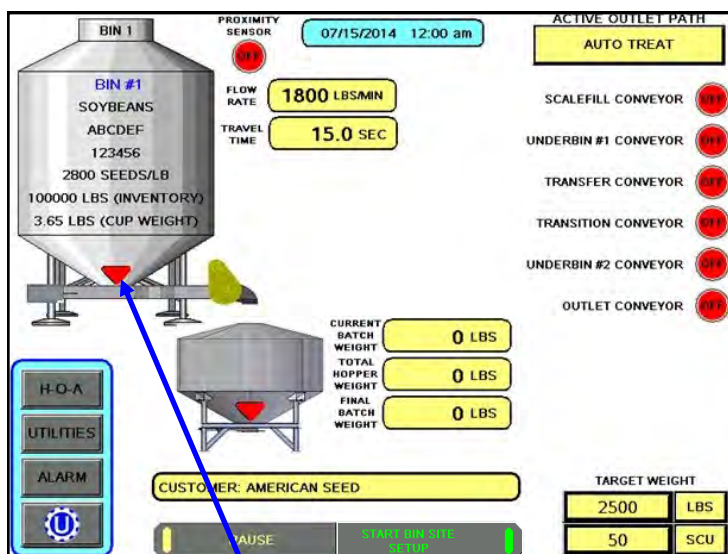

Slide Gate Indicator.

SECTION
D-4**TRI-FLO® CALIBRATION &
OPERATION****LOADING SEED INTO BINS**

Before seed is pulled out of the bins and run through the Tri - Flo ® System, all the applicable information about the seed that was loaded into each individual bin must first be entered into the Tri - Flo ® System. If the same seed was loaded into multiple bins the same information still needs to be loaded into each bin separately.

The following is a list of steps to perform to enter the bin information for each bin once seed has been loaded into that bin:

1. Load the seed into the bin. Take a seed sample for the cup weight of each bin at this time. Also, note the seed type, seed variety, lot number, seed weight and total inventory weight of the seed that is loaded into the bin. The seed weight can be defined in either pounds, seed count units or seed weight units.
2. Press the UTILITIES button in the lower left corner of the Bin Site main screen.
3. Press the SECURITY button on the bottom of the Utilities screen.
4. Press the PASSWORD box, then from the popup keyboard enter the letters USC and press enter.
5. Press the TOOLS & OPTIONS button in the lower left hand corner of the Security screen.
6. Press the BIN INFO button on the Tools & Options screen.

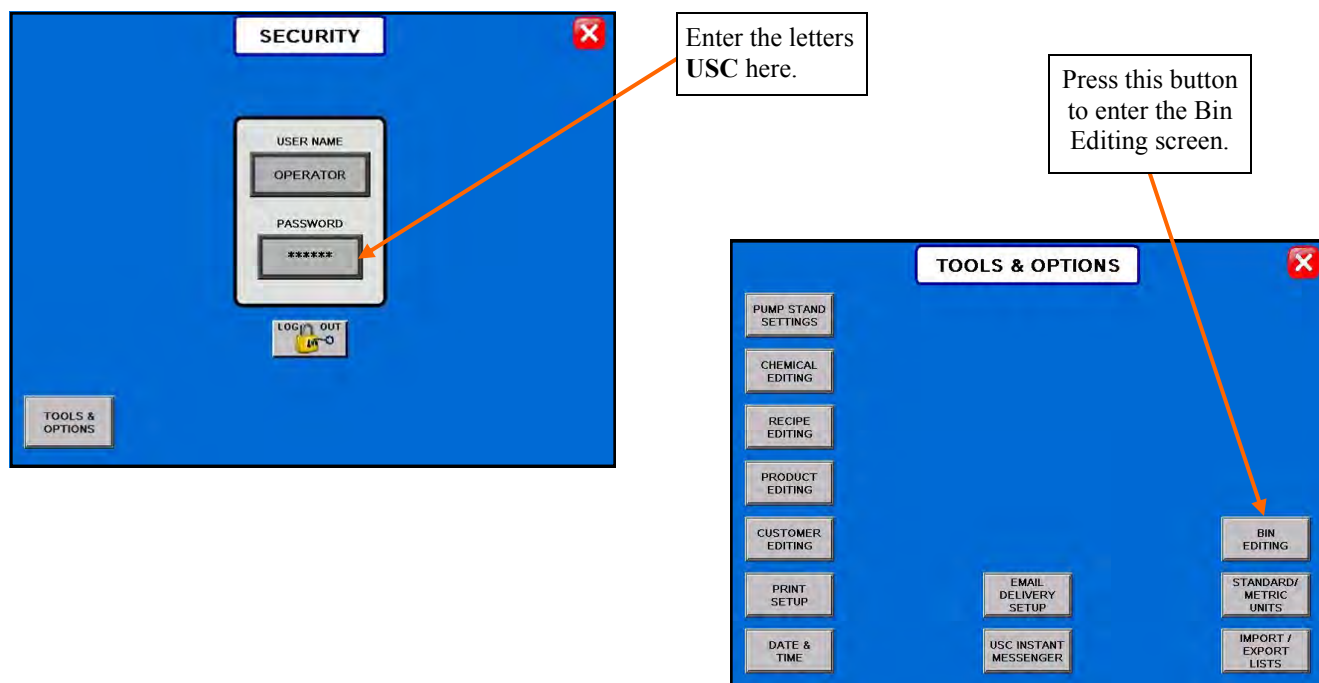

LOADING SEED INTO BINS

7. Select the desired bin to enter information into from the select bin list..
8. Enter the seed type, seed variety, lot number, seeds per pound and cup weight of the seed in the bin into their respective box under the Current Bin Info.
9. Enter in the total weight of seed that was added to the bin into the bin inventory section on the lower portion of the screen. The system will automatically subtract inventory after each run. Press the save button when all the information has been entered.
10. When finished, exit back to the Main screen.



SETTING THE SEED FLOW RATE

The following is a list of steps for setting the seed flow rate. This must be completed before running the Tri - Flo ® system. Repeat steps 1 & 2 for each bin.

1. Set the manual gate on the bin to the fully open position. Once opened, this gate should be set in place and not moved throughout the entire season. If this gate is adjusted during a run or between runs then it will affect the calibration of the system and the system will need to be re-calibrated (page 98).
2. Set the stop for the air actuated slide gate on the bin. This stop controls how far the slide gate will open and the flow rate at which seed can exit the bin. To set the stop, adjust the position of the collar on the rod that exits the slide gate opposite of the air valve (see page 129). Placing the collar closer to the slide gate will restrict flow and farther away from the slide gate will increase seed flow for the system. Once a collar location has been selected, use the hitch pin to lock the collar in place. If the stop is adjusted between runs then it will affect the calibration of the system and the system will need to be re-calibrated (page 98).

NOTICE

It is recommended to initially place the collar closer to the slide gate and then move it farther away from the slide gate one hole at a time to increase the flow rate of the system. This will protect against overloading the underbin conveyor with seed.

AVIS

Il est recommandé de placer d'abord le col plus proche de la valve à tiroir et le déplacer plus loin de la porte coulissante un trou à la fois pour augmenter la vitesse du système d'écoulement. Cela permettra de protéger contre la surcharge du convoyeur underbin avec des semences.

Note: A minimum of 2000 pounds is recommended but not necessarily needed to calibrate flow rate for the first time. The system needs roughly that amount to enter it's real time calibration (depending on the distance of the bin, it may be far less) but at the end of any alarm/pause free run of seed the system will do a calibration. If the run is long enough, then no initial calibration is needed as the system will set it's calibration during the run. If running a small batch there may not be enough seed run to have the flow rate updating in real time during the run. As long as there have been no pauses or alarms the system will re-calculate and update the flow rate display after the run is complete.

U-TREAT AUTOMATION MANUAL
SETTING THE SEED FLOW RATE

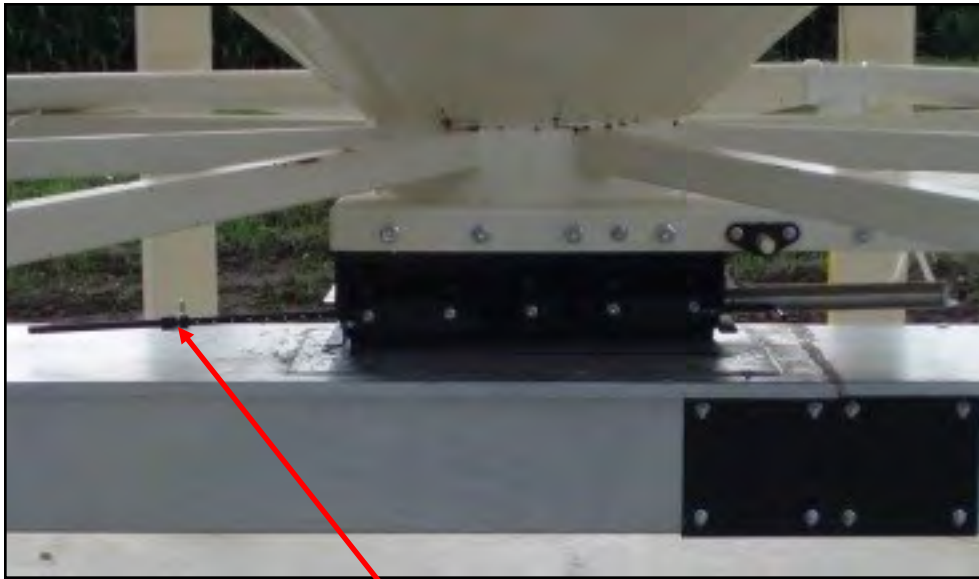

Move the position of the collar along this rod to adjust the flow of seed through the bin slide gate.

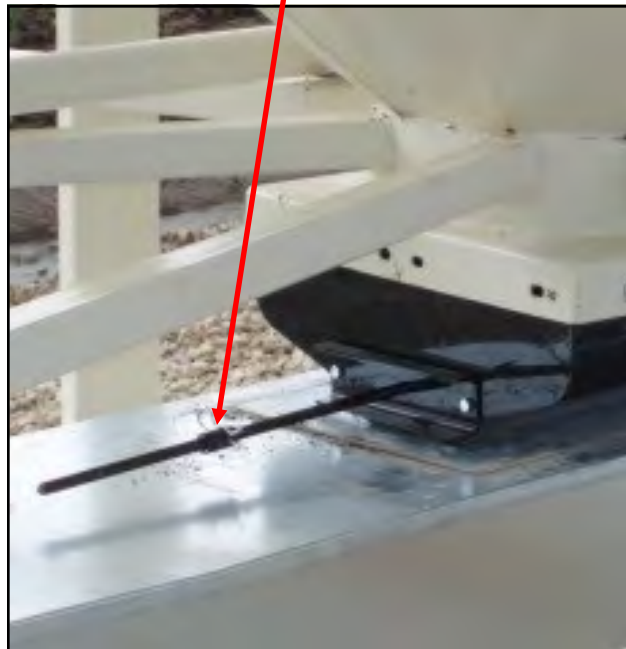

SCALE FILL FROM BIN

The following is a list of steps to use when running the Tri - Flo ® system in the Scale Fill From Bin mode of operation. This allows the operator to automatically fill the scale from the bin.

1. Under the H-O-A screen place all necessary conveyors into the AUTO mode of operation. (below left) Ensure that the diverter is in the appropriate position as well.
2. Under the Utilities screen, ensure that all settings are correct (below right).

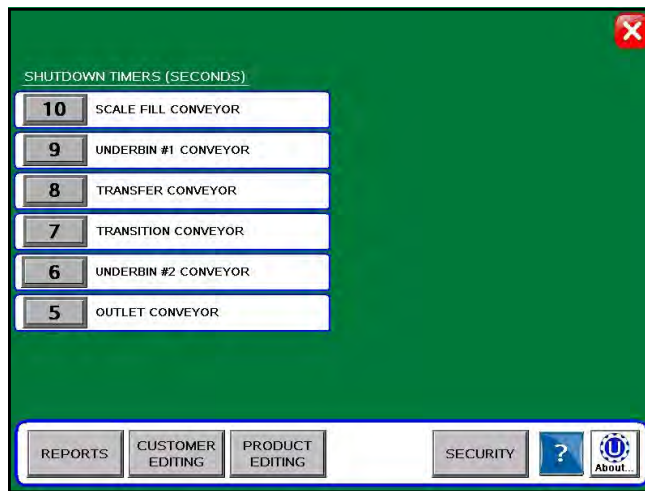
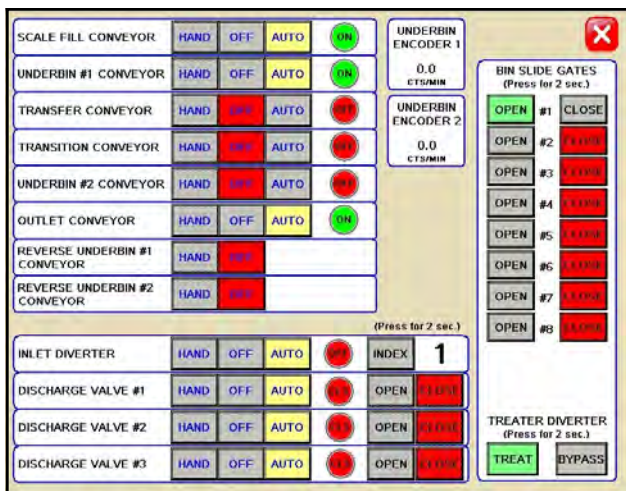

3. Press the START BIN SITE SETUP button on the Main screen.
4. Press the CUSTOMER button at the top of the setup screen and enter in the current customer's name in the search box or scroll through the rolodex with the navigation buttons.
5. Press the SELECTED BIN button and select the bin you want to pull seed from.
6. Press the TARGET WEIGHT button and enter the amount of weight that is to be brought into the Tri - Flo ® on this run.
7. Press the SEED OUTLET PATH button and then select either AUTO TREAT or MANUAL TREAT mode of operation depending upon what you plan to do with the seed once it has been pulled from the bin and weighed by the Tri-Flo® system. There may be other names set for different outlet paths an operator may see based on different configuration settings.

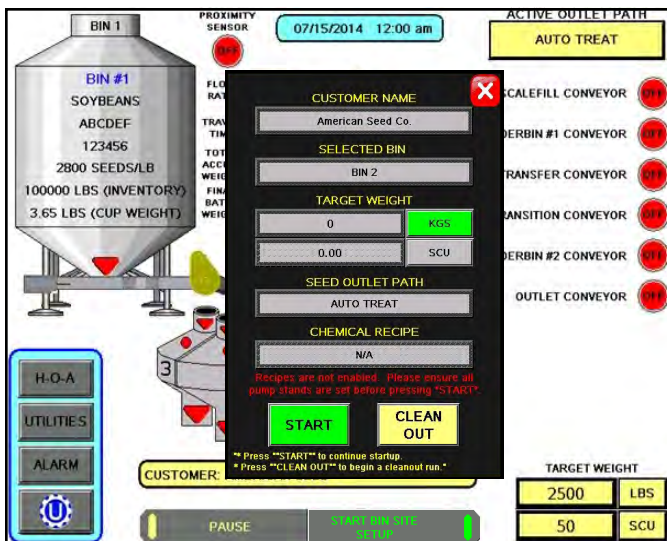

SCALE FILL FROM BIN

8. If the enable recipe controls are active on the recipe screen (see page 29), the CHEMICAL RECIPE button will be active and you may select one from this screen.
9. Press the START button at the bottom of the startup screen. This toggles the button to CANCEL SCALE FILL FROM BIN and activates the PAUSE button. The system will first turn on the scale fill conveyor and then the underbin conveyor. Once all needed conveyors are running, the slide gate for the selected bin will open and seed will flow through the conveyors to the Tri - Flo ® hoppers.
10. As the Tri - Flo ® system is running, the main screen will display the total pounds of seed in each of the three weight hoppers, and the status of the conveyor motors.
11. The slide gate on the bin will automatically close once the target weight in seed passes through the slide gate. Once the gate closes, a window will appear notifying the operator that the batch is finishing. It will then be replaced with another window indicating amount of time before the system shuts down. If operating in the Manual Treat mode the treater will have to be turned on and off separately. The system will then shutdown the conveyors in reverse order of startup. This will ensure the conveyors have an opportunity to clean out any product from them.
(bottom)

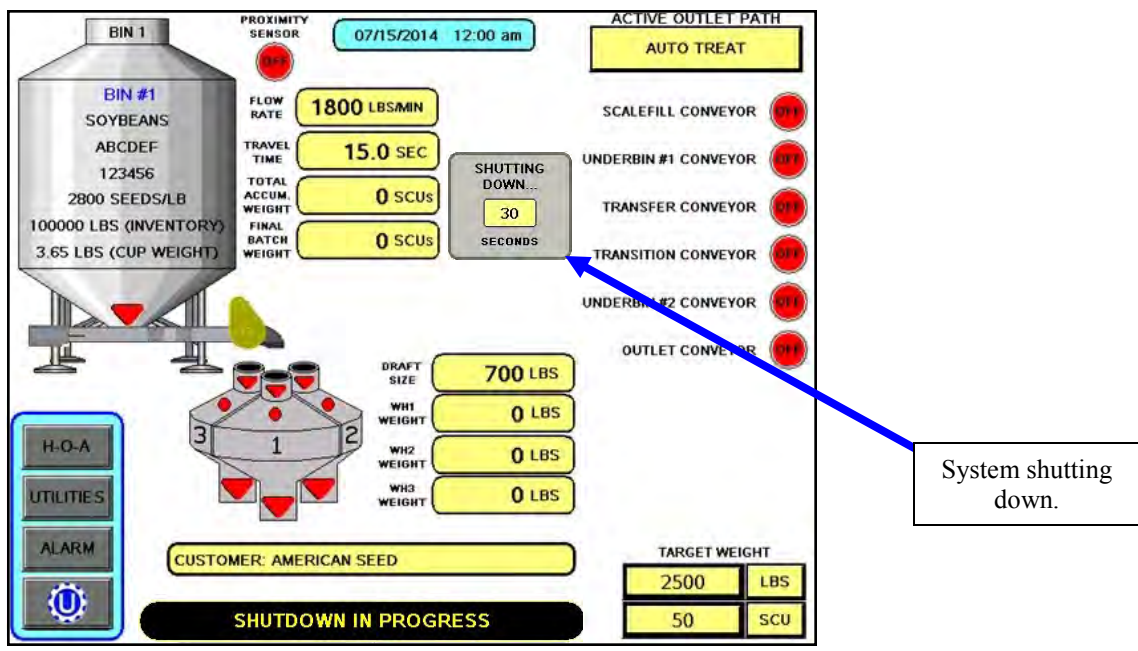

CALLING IN SEED FROM PRO BOXES

The following is a list of steps to use when running the Tri - Flo ® system in the Scale Fill From Manual Hopper mode of operation. This allows the operator to automatically fill the scale from Pro Box.

- Under the H-O-A screen place all necessary conveyors into the AUTO mode of operation. Depending upon the setup of the equipment, some bin sites will require only the transfer conveyor or the scale fill conveyor to be in AUTO mode and some sites will require the transfer, underbin and scale fill conveyors to all be in the AUTO mode. Ensure that the diverter is in the appropriate position as well.
- Under the Utilities screen, ensure that all settings are appropriate.
- Press the START BIN SITE SETUP button on the Main screen.
- Press the CUSTOMER button at the top of the setup screen and enter in the current customer's name in the search box or scroll through the rolodex with the navigation buttons.
- Press the SEED OUTLET PATH button, then select either AUTO TREAT or MANUAL TREAT mode of operation depending upon what you plan to do with the seed once it has been pulled from the Pro Box and weighed by the Tri - Flo ® system. There may be other names set for different outlet paths an operator may see based on different configuration settings.
- Press the SELECTED BIN button and select the Manual Hopper.
- From the MANUAL HOPPER screen, enter the seed type, seed variety, lot number, seeds per unit of measurement and cup weight for the seed.

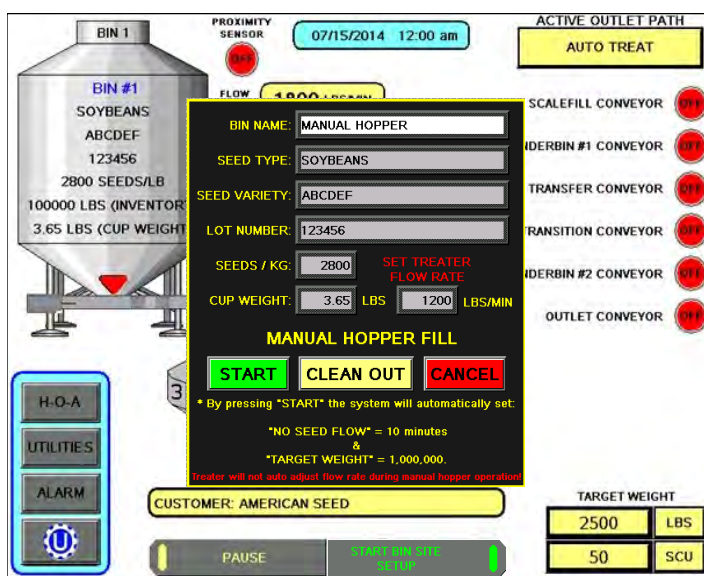
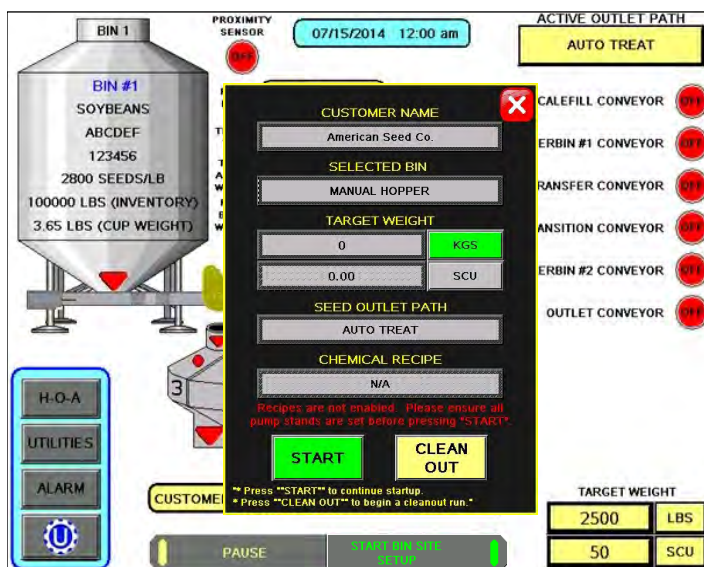

CALLING IN SEED FROM PRO BOXES

8. Once all seed information has been entered, press START. This toggles the button to FINISH SCALE FILL FROM HOPPER and activates the PAUSE button. The system will first turn on the scale fill conveyor, the underbin conveyor, then the transfer conveyor (If applicable) and the outlet conveyor (If applicable).
9. As the Tri - Flo ® system is running, the main screen will display the total pounds of seed in each of the three Tri - Flo ® weigh hoppers. If the system needs to be stopped for a moment because of a problem, the PAUSE button may be pressed to halt the process. When ready to begin again, press the CONTINUE button.
10. Once all of the seed has passed from the manual hopper, through the conveyors and through the weigh hoppers, press the FINISH SCALE FILL FROM HOPPER button. At this point, the conveyors will shutdown in reverse order of startup.
11. The system will automatically print the report for the run from the scale head printer.

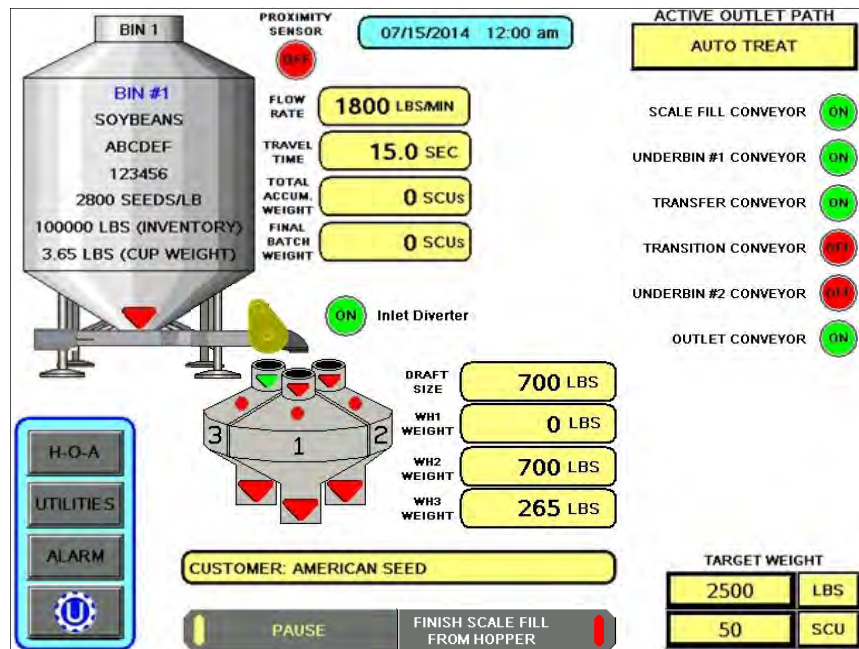

TRI - FLO® CALIBRATION

Once the initial calibration is established, the system continuously updates the seed flow rate. The calibration is based upon time and weight. The system first calculates the amount of time it takes for the seed to travel from the bin slide gate to the first Tri - Flo® weigh hopper. This is called the travel time. Then the system calculates how long it takes to fill the first weigh hopper. This allows the system to calculate the seed flow rate of pounds per minute. Finally, the system uses the travel time and seed flow rate to calculate the amount of seed in the conveyors at any given time. Once this weight is known, it will automatically close the bin gate at the appropriate time to reach the target weight of seed that the operator has entered.

Initial calibration procedure:

1. Set the bin collar in the fourth hole from the end of the rod in. This sets the Flow Rate at approximately 1200 pounds. Adjust as needed (each hole adjusts up or down by approximately 200 pounds). These figures are based on Soybeans.
2. From the main screen check the Flow Rate to verify it is at the default setting of 1800 lbs/min and the Travel Time is at its default of 15.0 sec. Then set your Target Weight at 2000 pounds. At the end of the run the Final Batch Weight must be 1500 pounds. These values are recommended but not necessary depending on the setup. For the system to be able to record the calibration the first two Tri - Flo® hoppers must be weighed full and the third is in the process of filling with no alarm faults. After the run, check to see if the Flow Rate and Travel Time have changed from the default settings. If they have the system has been successfully calibrated. Each bin must be individually calibrated. If running a small batch there may not be enough seed run to have the flow rate updating in real time during the run. As long as there have been no pauses or alarms the system will re-calculate and update the flow rate display after the run is complete.

NOTE: If you change the location of the bin collar or the bin runs out of seed before the Target Weight is reached the system will need to be re-calibrated.

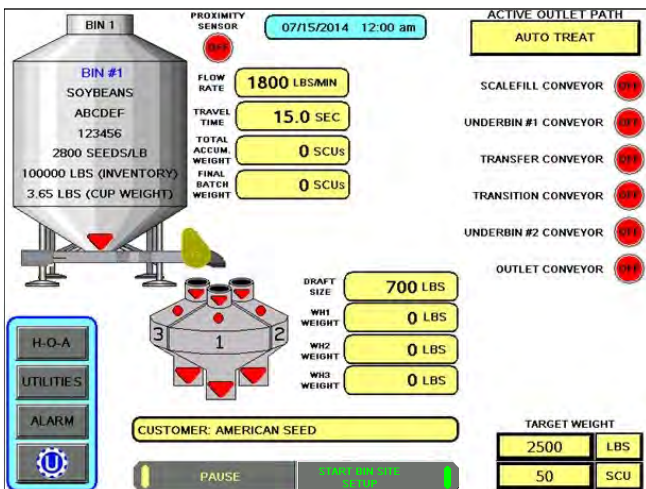

UNDERBIN OPERATION IN REVERSE MODE

The following is a list of steps to use when running the Tri - Flo ® system using the Reverse mode. This mode of operation will allow the operator to clean out the underbin conveyor and to remove any excess seed from the bins at the end of the treating season. **ALWAYS ENSURE THE BELT IS IMMEDIATELY AND PROPERLY ALIGNED WHEN RUNNING IN REVERSE! BELTS WILL OFTEN SHIFT ALIGNMENT WHEN THEIR DIRECTION OF TRAVEL IS REVERSED.**

The REVERSE UNDERBIN CONVEYOR for the underbin conveyor will only be present if the Tri - Flo ® system has the reversing option for the underbin conveyor.

1. Place a conveyor and seed storage container under the reversing end of the underbin conveyor to catch seed as it exits the underbin conveyor. Turn that conveyor motor on.
2. Under the H-O-A screen place the REVERSE UNDERBIN CONVEYOR operation in the HAND mode. (top) Ensure that the belt on the underbin conveyor is correctly aligned.
3. Then, manually place the desired bin slide gate to the OPEN position. (top)
4. The Tri - Flo ® Main Screen will show the underbin conveyor on and the bin slide gate in the open position (bottom).
5. Once all seed has passed through the underbin conveyor and into the seed container, place the open bin slide gate back to the CLOSED position.
6. Allow the underbin conveyor to run for at least 15 seconds. This will allow the underbin conveyor to clean itself out. Then place the underbin conveyor motor back to the OFF position.

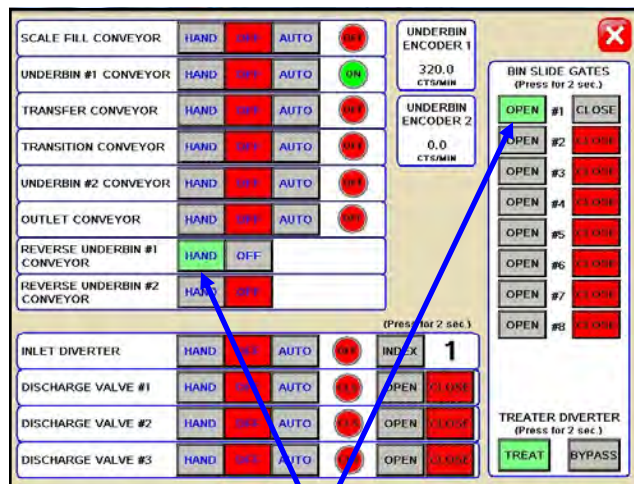

Press the HAND button and then place the bin slide gate to the OPEN position.

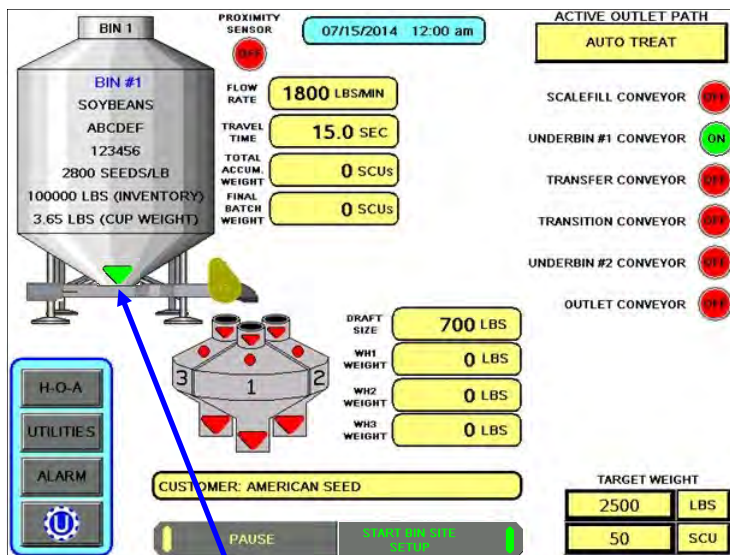

Slide Gate Indicator.

TROUBLESHOOTING

This section contains tables describing the most frequent problems and solutions with the USC systems on the pages noted below. For further assistance, contact the USC Service department at (785) 431-7900.

- LPX & LPV Treater troubleshooting table pg. 138.
- LPV LIW Only Treater troubleshooting table pg. 140.
- Batch Hopper troubleshooting table : pg. 147.
- Tri - Flo ® troubleshooting table : pg. 152.

SYSTEM ALARMS - FAULTS

The table on the pages noted below provide a general description of all the system alarms (faults & warnings) of the different USC systems. When a fault or warning condition is detected by the system, the alarms screen will pop-up describing the cause of the alarm or fault. Any motor fault will activate the alarm screen on the operator control panel. If running, the system will then progress to the pause state. A warning will alert the operator of a system condition which needs attention or correction. The alarms are reset when the fault condition is cleared and the Reset button is pressed. The horn is silenced by pressing the Silence button on the alarm screen. The arrows on the right allow the operator to scroll through the listing. For further assistance, contact the USC Service department at (785) 431-7900.

- LPX & LPV Treater system alarm - faults table pg. 142.
- LPV LIW Only Treater system alarm-faults table pg. 145.
- Batch Hopper system alarm-faults table : pg. 149.
- Tri - Flo ® system alarm-faults table : pg. 155.

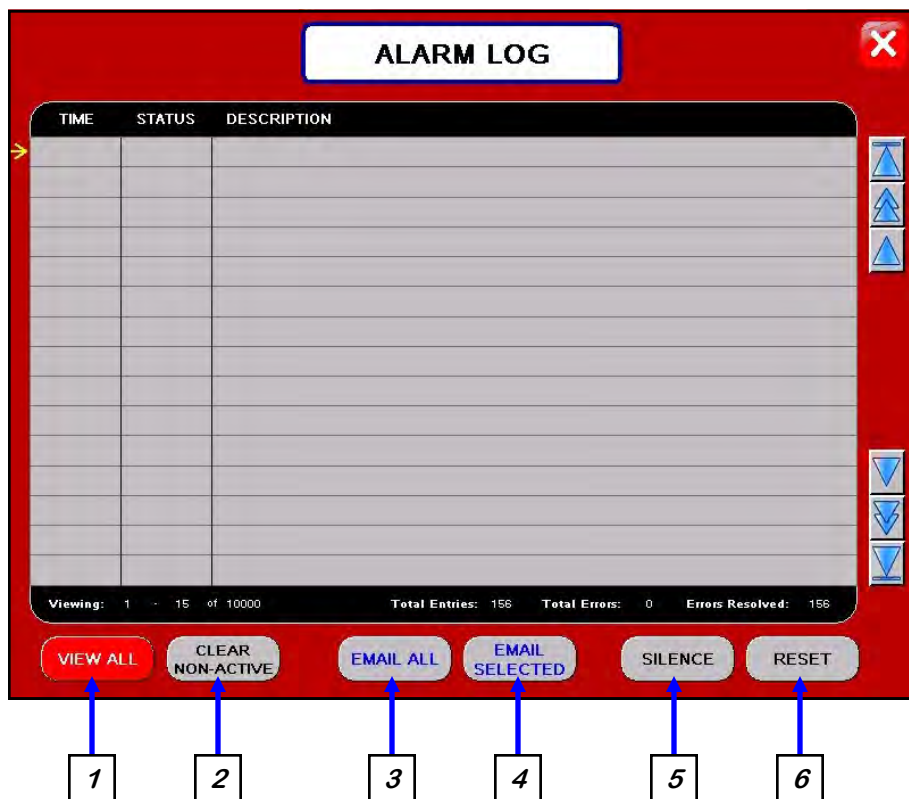
ALARM LOG SCREEN

1. VIEW LIST: This button toggles between View All to display all alarms and faults stored at any given time (the button will be red) and Hide All which will hide all alarms except the active ones. When an alarm or fault occurs, it will be shown in the list with a red background until the Silence button is pressed, then it will turn yellow.

2. CLEAR NON-ACTIVE: The alarm status will change to Acknowledged once an alarm condition has been resolved and the Reset button has cleared the alarm. Pressing this button will clear all alarms with the status of acknowledged.

3. EMAIL ALL: Pressing this button will email all of the alarms in the list to the address defined on the Delivery Settings screen (see page 38).

4. EMAIL SELECTED: This button will email an individual alarm. Press the report on the screen you wish to email. The yellow arrow will be positioned to the left of the selected report as confirmation. Push the button and the report will be sent to the address defined on the Delivery Settings screen (see page 38).

5. SILENCE: Pressing this button will shut off the alarm siren and change the background of the active alarm or fault to yellow while the operator is resolving the issue.

6. RESET: After you think you have resolved the issue that caused the alarm, pressing this button will clear the alarm as confirmation. If you did not correct the problem it will alarm again.

**SECTION
E-1**

TREATER TROUBLESHOOTING

LPX & LPV TREATER

Problem	Possible Cause	Solution
Inlet Conveyor will not turn on.	<ol style="list-style-type: none"> 1. Inlet Conveyor proximity switch is activated. 2. Inlet Conveyor proximity switch is too sensitive. 3. Conveyor is plugged into wrong outlet on seed treater panel. 	<ol style="list-style-type: none"> 1. Clean proximity switch. 2. Adjust the Inlet Conveyor proximity switch sensitivity by turning the adjustment screw counter-clockwise (page 141). 3. Check to make sure the Inlet Conveyor is plugged into the inlet conveyor receptacle.
Pump will not turn off in AUTO when seed runs out.	<ol style="list-style-type: none"> 1. Proximity switch is dirty. 2. Proximity switch is set too sensitive. 	<ol style="list-style-type: none"> 1. Clean proximity switch. 2. Adjust the pump proximity switch sensitivity by turning adjustment screw counter-clockwise (page 141).
Pump will not turn on in AUTO.	<ol style="list-style-type: none"> 1. Proximity switch is not staying covered. 2. Proximity switch is not sensitive enough. 	<ol style="list-style-type: none"> 1. Make sure proximity switch is staying covered with seed. 2. Adjust pump proximity switch sensitivity by turning the adjustment screw clockwise (page 141).
Inlet conveyor won't shut off when supply hopper is full.	<ol style="list-style-type: none"> 1. Seed is not hitting proximity switch. 2. Proximity switch is not set sensitive enough. 3. Inlet Conveyor is plugged into wrong receptacle. 	<ol style="list-style-type: none"> 1. Make sure seed is hitting proximity switch. 2. Adjust the inlet conveyor proximity switch by turning the adjustment screw clockwise (page 141). 3. Make sure Inlet Conveyor is plugged inlet conveyor receptacle.
Shutdown due to not having all needed devices available.	<ol style="list-style-type: none"> 1. An interlock on one of the bin site conveyors is not properly setup and is keeping the conveyor from starting. 2. The system was PAUSED during startup. 	<ol style="list-style-type: none"> 1. Contact USC service department for assistance with changing the interlock. 2. Restart the run of seed.

LPX & LPV TREATER

Problem	Possible Cause	Solution
Pump is fluctuating.	<ol style="list-style-type: none"> 1. Restriction in tubing 2. Filter is plugged or missing gasket. 	<ol style="list-style-type: none"> 1. Flush tubing and check filter for any restrictions. 2. Clean filter and check for gasket.
Seed calibration is fluctuating.	<ol style="list-style-type: none"> 1. Seed treater supply hopper is not staying full. 2. Restriction in the supply hopper or seed wheel. 3. Build-up in the atomizing chamber. 	<ol style="list-style-type: none"> 1. Make sure the supply hopper and seed wheel are staying full. May have to lower seed flow rate in order to have a consistent flow of seed. 2. Check supply hopper and seed wheel for any debris, and remove. 3. Remove atomizing housing and clean out any build-up of material.
Drum is slipping and seed is coming out the inlet side of the drum.	<ol style="list-style-type: none"> 1. Drum is wet. 2. The seed treater is set too level. 3. Chains are too loose. 	<ol style="list-style-type: none"> 1. Dry off any moisture that may have collected on the outside of the drum. 2. Adjust the slope of the seed treater to at least a 3" drop from front to back. If desired, more slope can be applied. 3. Check and tighten the drive chains. Also check the chain alignment.
None of the motors will turn to ON in HAND mode.	<ol style="list-style-type: none"> 1. Processor is faulted. 2. Emergency Stop button is activated. 	<ol style="list-style-type: none"> 1. Disconnect power and wait 30 seconds before reconnecting power. 2. Pull out the emergency stop button.
E-stop is flashing.	<ol style="list-style-type: none"> 1. An E-stop may be depressed. 2. Power may not be on to the control panels. 3. One of the control panels may not be connected to all of the others. 	<ol style="list-style-type: none"> 1. Ensure all E-stops are not depressed. 2. Check incoming power to each control panel. 3. Check the wiring and connections to each control panel.

LPV LIW TREATER ONLY

Problem	Possible Cause	Solution
Seed Gate Actuator will not move.	<ol style="list-style-type: none"> 1. Adjustable Chamber mechanism jammed with debris. 2. One or both of the two connectors linking the actuator to the control panel are not connected. 	<ol style="list-style-type: none"> 1. Clear all debris and make sure mechanism moves freely. 2. Make sure both connectors are properly engaged.
Seed Gate Actuator will not return to the closed position after all seed has emptied from the box.	<ol style="list-style-type: none"> 1. Proximity switch is dirty. 2. Proximity switch is set too sensitive. 3. The system is running in HAND mode. 	<ol style="list-style-type: none"> 1. Clean proximity switch. 2. Adjust the pump proximity switch sensitivity (see page 141). 3. Change to AUTO mode.
Seed Gate Actuator will not move in AUTO.	<ol style="list-style-type: none"> 1. Proximity switch is not staying covered. 2. Proximity switch is not set sensitive enough. 3. HMI screen not set to AUTO. 	<ol style="list-style-type: none"> 1. Make sure proximity switch is staying covered with seed. 2. Adjust pump proximity switch sensitivity by turning the adjustment screw clockwise. 3. Set HMI screen to AUTO.
Seed Gate Actuator will not close completely.	<ol style="list-style-type: none"> 1. Debris may be keeping it from closing completely. 	<ol style="list-style-type: none"> 1. Open the seed gate, remove debris and power cycle the entire system. When the system is turned back on, the gate will automatically close and find it's Home position.
Drum Actuator not moving and stopping at the correct time.	<ol style="list-style-type: none"> 1. The connector linking the control panel to the actuator is not connected. 2. The Actuator Calibration parameters have not been set or are set incorrectly. 	<ol style="list-style-type: none"> 1. Make sure the connector is properly engaged. 2. From the Utilities page, press the Drum Actuator Calibration button and ensure the settings are correct.

PROXIMITY SWITCH ADJUSTMENT GUIDE

The proximity switches mounted in the extension ring and the seed wheel detect when seed is present.

The proximity switch located in the extension ring is used to automatically shut off the inlet conveyor when the surge hopper is full. This proximity switch is not present on tower systems.

The proximity switches located in the seed wheel automatically shut off the pump when all seed has left the hopper.

If the proximity switch is not working properly, this can be caused by wear, dust, or even moisture. The first step is to clean the lens of the proximity switch. If this does not solve the problem, the next step would be to adjust the sensitivity of the proximity switch.

The green light indicates the power status. If it is active the device is powered.

The amber light indicates when seed is being detected. If it is active it detects seed, if inactive it does not detect seed.

Using the small screwdriver provided inside the control panel, you can adjust the proximity switch by turning the adjusting screw on the back of the proximity switch.

- Turn Clockwise to make the proximity switch more sensitive.
- Turn Counterclockwise to make the proximity switch less sensitive.

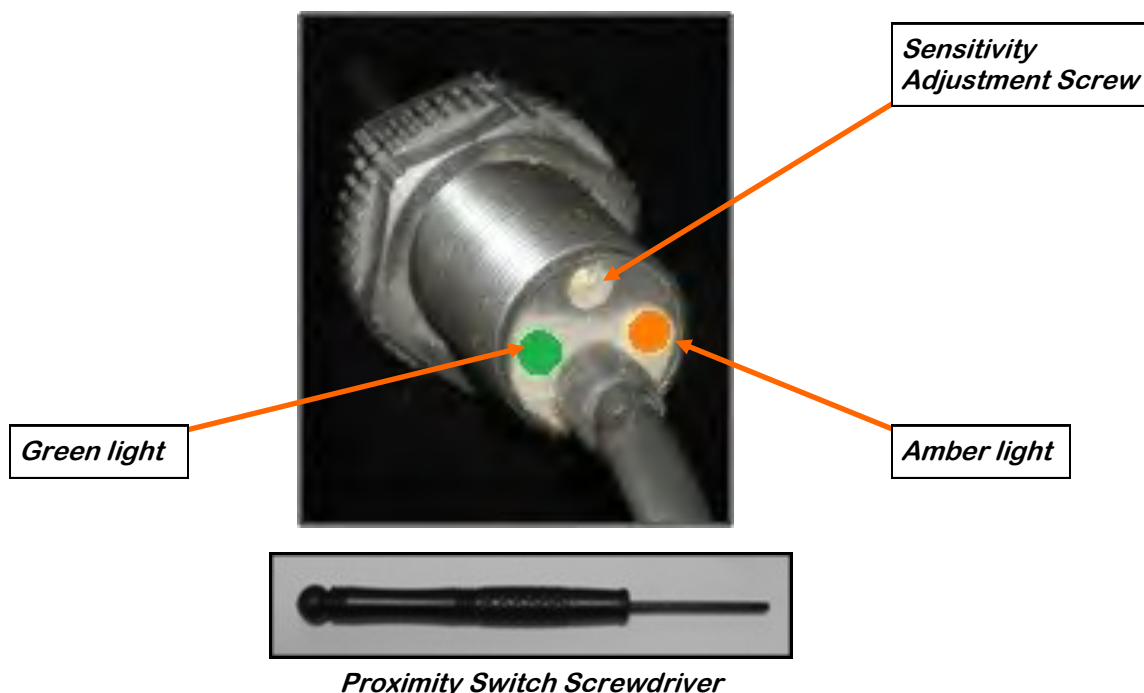

SYSTEM ALARMS - FAULTS

Below is a table describing the most frequent system alarms, faults and solutions with the USC Automated Seed Treater.

For further assistance, contact USC at (785) 431-7900.

LPX & LPV TREATER

Alarm - Fault	Possible Cause	Solution
Drum Motor Fault	<ol style="list-style-type: none"> 1. No signal from Drum motor drive (VFD) indicating that the Drum is running. 2. Drum motor has been shutdown while in Auto mode of operation. 	<ol style="list-style-type: none"> 1. Verify that the VFD is powered up, or check if it is faulted out. Check the Information screen. 2. Verify that the Drum was not turned OFF while the system was in Auto mode of operation.
Seed Wheel Motor Fault	<ol style="list-style-type: none"> 1. No signal from Seed Wheel motor drive (VFD) indicating that the Seed Wheel is running. 2. Seed Wheel motor has been shutdown while in Auto mode of operation. 	<ol style="list-style-type: none"> 1. Verify that the VFD is powered up, or check if it is faulted out. Check the Information screen. 2. Verify that the Seed Wheel was not turned Off while the system was in Auto mode of operation.
Atomizer Motor Fault	<ol style="list-style-type: none"> 1. No signal from Atomizer motor drive (VFD) indicating that the Atomizer is running. 2. Atomizer motor has been shutdown while in Auto mode of operation. 	<ol style="list-style-type: none"> 1. Verify that the VFD is powered up, or check if it is faulted out. 2. Verify that the Atomizer was not turned OFF while the system was in Auto mode of operation.
Flow rate less than 300 or greater than 1800 lbs/min 136-820 KGS/min	<ol style="list-style-type: none"> 1. There could be an obstruction in the seed path. 2. May have set run speed to high. 	<ol style="list-style-type: none"> 1. Check seed path for obstruction and remove it. 2. Slow run speed down.
Treater Inlet Conveyor Motor Fault	<ol style="list-style-type: none"> 1. Inlet Conveyor motor auxiliary contact was not sensed after being energized to run. 	<ol style="list-style-type: none"> 1. Verify that the motor starter has power and is turned on.

LPX & LPV TREATER

Alarm - Fault	Possible Cause	Solution
Treater Outlet Conveyor Motor Fault	1. Outlet Conveyor motor auxiliary contact was not sensed after being energized to run.	1. Verify that the motor started has power and is turned on.
Pump - Not In Process:	1. Valve of the liquid displayed failed to divert to process when requested.	1. Verify valve has diverted, if so troubleshoot sensor, if not check air supply and signal to valve.
Seed Wheel - Lbs/Min Under Range	1. Actual Lbs/Min is under 95% of target rate.	1. Make sure the VFD is not maxed out at the specified target rate. Check for sluggish or oscillating Seed Wheel response. Call the manufacturer.
Check Operation Of Seed Sensors In Seed Wheel	1. Seed Wheel is in Auto mode of operation, and only one proximity sensor has been activated for the past ten seconds.	1. Verify both proximity sensors are working properly. (This alarm will also be activated if seed is only flowing through one side of the seed wheel.)
Treater Pump # Liquid Flow Rate Alarm: Flow is more than ## percent out of range for X seconds.	1. Filter may be clogged. 2. Hoses may be obstructed. 3. Pump Head not locked down. 4. Pump Head hoses may be worn out.	1. Remove filter and clean. 2. Check to see if hoses are blocked or pinched. May need to clean or replace. 3. Lock down Pump Head. 4. Replace Pump Head hoses.
Treater Pump # Liquid Flow Rate Alarm: Flow is more than xxx out of range for X seconds.	1. Filter may be clogged. 2. Hoses may be obstructed. 3. Pump Head not locked down. 4. Pump Head hoses may be worn out.	1. Remove filter and clean. 2. Check to see if hoses are blocked or pinched. May need to clean or replace. 3. Lock down Pump Head. 4. Replace Pump Head hoses.
Pump ## Three Way Valve Not In Process Alarm	1. Valve of the liquid displayed failed to divert to process when requested.	1. Verify valve has diverted, if so troubleshoot sensor, if not check air supply and signal to valve.
Treater Surge Suppressor - L1 FAILED!!!	1. L1 of the Surge Protector will no longer protect the electrical panel against voltage surges.	1. Replace the Surge Protector.

LPX & LPV TREATER

Alarm - Fault	Possible Cause	Solution
Check pump flow rate - Must be above 80% Target Rate for 30 seconds	<ol style="list-style-type: none"> 1. Filter may be clogged. 2. Hoses may be obstructed. 3. Pump Head not locked down. 4. Pump Head hoses may be worn out. 	<ol style="list-style-type: none"> 1. Remove filter and clean. 2. Check to see if hoses are blocked or pinched. May need to clean or replace. 3. Lock down Pump Head. 4. Replace Pump Head hoses.
Check pump flow rate - Less than 10oz/min below Target Rate for 10 seconds	<ol style="list-style-type: none"> 1. Filter may be clogged. 2. Hoses may be obstructed. 3. Pump Head not locked down. 4. Pump Head hoses may be worn out. 	<ol style="list-style-type: none"> 1. Remove filter and clean. 2. Check to see if hoses are blocked or pinched. May need to clean or replace. 3. Lock down Pump Head. 4. Replace Pump Head hoses.
Check pump flow rate - Less than 50% Flow Rate for 5 seconds	<ol style="list-style-type: none"> 1. Filter may be clogged. 2. Hoses may be obstructed. 3. Pump Head not locked down. 4. Pump Head hoses may be worn out. 	<ol style="list-style-type: none"> 1. Remove filter and clean. 2. Check to see if hoses are blocked or pinched. May need to clean or replace. 3. Lock down Pump Head. 4. Replace Pump Head hoses.
Check pump flow rate - Less than 80% Flow Rate for 10 seconds	<ol style="list-style-type: none"> 1. Filter may be clogged. 2. Hoses may be obstructed. 3. Pump Head not locked down. 4. Pump Head hoses may be worn out. 	<ol style="list-style-type: none"> 1. Remove filter and clean. 2. Check to see if hoses are blocked or pinched. May need to clean or replace. 3. Lock down Pump Head. 4. Replace Pump Head hoses.
Mix Tank ## Motor Fault	<ol style="list-style-type: none"> 1. Mix Tank motor auxiliary contact was not sensed after being energized to run. 	<ol style="list-style-type: none"> 1. Verify that the motor starter has power and is turned on.

LPV LIW TREATER ONLY

Alarm - Fault	Possible Cause	Solution
Drum Tilt Actuator NOT in position.	<ol style="list-style-type: none"> 1. Connector on the actuator not completely engaged. 2. Something is physically obstructing the drum from returning to the start position. 	<ol style="list-style-type: none"> 1. Check connection to ensure a tight connection. 2. Locate and clear the obstruction.
Dyadic Actuator NOT in requested position.	<ol style="list-style-type: none"> 1. Adjustable Chamber mechanism jammed with debris. 2. One or both of the two connectors linking the actuator to the I/O control panel are not connected. 3. One or both ends of the ethernet cable is not connected to the I/O control panel or the Main control Panel. 	<ol style="list-style-type: none"> 1. Open the seed gate, remove debris and power cycle the entire system. When the system is turned back on, the gate will automatically close and find it's HOME position. 2. Ensure that both connectors are securely connected to the I/O control panel. 3. Ensure that both connectors are securely connected to the control panels.
LPV Treater I/O panel: Ethernet Communication Failure.	<ol style="list-style-type: none"> 1. One or both ends of the ethernet cable is not connected to the I/O Control panel or the Main Control Panel. 2. Connections are good but cable is damaged. 	<ol style="list-style-type: none"> 1. Ensure that both ends of the cable are connected to the control panels. 2. Replace damaged cable.
Internal Dyadic Actuator error detected on flow control gate. Press alarm "RESET ALARMS" button to initiate the reset of the actuator.	<ol style="list-style-type: none"> 1. Adjustable Chamber mechanism jammed with debris. 2. One or both of the two connectors linking the actuator to the I/O control panel are not connected. 3. One or both ends of the ethernet cable is not connected to the I/O control panel or the Main control Panel. 	<ol style="list-style-type: none"> 1. Open the seed gate, remove debris and power cycle the entire system. When the system is turned back on, the gate will automatically close and find it's HOME position. 2. Ensure that both connectors are securely connected to the I/O control panel. 3. Ensure that both connectors are securely connected to the control panels.
Gate Position Actuator at maximum position and desired flow rate has not been achieved. Check for seed flow restrictions.	<ol style="list-style-type: none"> 1. Flow rate may be set to high for the type of seed being treated. 2. Value for the Max Gate position is set to low. 	<ol style="list-style-type: none"> 1. Lower the target flow rate. 2. Go to the Product Editing page and make sure the Max Gate Position is set to at least 18000.

SYSTEM MESSAGES

The table below provides a general description of some of the system messages that could occur. When a warning condition is detected, a window will appear (below) notifying the operator that the system will not start because of a certain condition. When the condition has been corrected, the START button can be pressed to start the system.

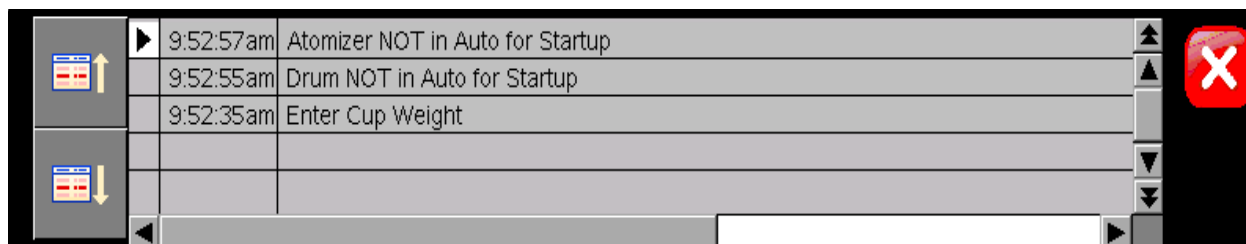

Message
Atomizer NOT in Auto or Ready for Startup
Drum Not In Auto or Ready For Startup
Treater outlet conveyor is not in auto.
Automatic seed flow rate adjustment has occurred. Seed flow rate was out of range.
Pumps 5-8: Ethernet Communication Failure
Pumps 9-12: Ethernet Communication Failure
Reports are nearly full. Please, save reports to USB and then delete reports.
Reports are full. Information loss may occur!
Seed wheel not in auto or ready for startup.
Bin site shutdown due to not having all needed devices available for operation. Contact USC Service Rep for assistance.
Treater seed flow rate is set higher than the calculated bin site seed flow rate.
Enter Cup Weight
No Product Selected
Auto Startup - No Seed Type match
Treater Reports - FULL. Transfer reports to USB to keep from losing data.
Treater Reports - almost FULL. Transfer reports to USB.
Conveyor # is not in auto.
Operation not selected.

BATCH HOPPER TROUBLESHOOTING**SECTION
E-2****TROUBLESHOOTING**

Below is a table describing the most frequent problems and solutions with the USC Batch Weigh Hopper system. For further assistance, contact USC at (785) 431-7900.

Problem	Possible cause	Solution
System is not consistently calibrating correctly.	<ol style="list-style-type: none"> 1. Bin slides gates or manual gates have been moved. 2. Underbin conveyor belt is slipping. 3. Bin slide gate is not consistently opening to the same point. 4. The operator is pressing the CANCEL SCALE FILL button before the run ends. 5. System is being paused during the run. 	<ol style="list-style-type: none"> 1. Ensure that the slide gate collar and manual gate is locked into place. Then recalibrate. 2. Tighten the underbin conveyor belt. 3. Check for any obstruction that may be restricting the movement of the slide gate. 4. Allow the system to shutdown on its own. 5. Make another run without pausing system.
System calibration for currently selected bin is incorrect.	<ol style="list-style-type: none"> 1. System is too far out of calibration to recalibrate automatically. 	<ol style="list-style-type: none"> 1. Recalibrate the system. (see page 118)
Weight display not reading steady (Bouncing)	<ol style="list-style-type: none"> 1. Bad load cell. 2. Wind Drafts. 3. Poor grounding. 	<ol style="list-style-type: none"> 1. Replace load cell. 2. Close doors. 3. Check grounding and ensure that it meets all area codes.
No scale reading on the weigh hopper indicator on the touch screen.	<ol style="list-style-type: none"> 1. Ethernet cable is disconnected. 2. Scale head is unplugged. 	<ol style="list-style-type: none"> 1. Check all Ethernet cables for connectivity and damage. 2. Ensure that the scale head has power and is turned on.
Scale is reading incorrect weight.	<ol style="list-style-type: none"> 1. Something is touching the scale. 2. Scale needs recalibrated. 3. Ethernet cable may be damaged or receiving electrical interference 	<ol style="list-style-type: none"> 1. Ensure that the area around the scale is clean and that nothing is leaning on or resting on the hopper. 2. Zero scale. If still incorrect, have a professional scale technician recalibrate the scale. 3. Ensure that Ethernet cable is not located directly next to any electrical lines.

TROUBLESHOOTING

Problem	Possible Cause	Solution
No bin slide gates will open or close when their corresponding button is pressed on the touch screen.	<ol style="list-style-type: none"> 1. No air or not enough air is being supplied to the solenoid bank on the side of the bin site control panel. 2. The bin site panel may be off. 3. Power surge has disrupted electrical communications. 	<ol style="list-style-type: none"> 1. Ensure that at least 100 psi of air is being supplied to the solenoid bank. 2. Ensure that the bin site control panel has power to it, is on and that all of the breakers inside the panel are on as well. 3. Power off all panels for 30 seconds then power them back on.
Air gate will not close fully.	<ol style="list-style-type: none"> 1. Something is obstructing the air gate from closing. 2. Air pressure to the gate is not strong enough. 	<ol style="list-style-type: none"> 1. Remove obstruction. 2. Ensure that the bin slide gate has at least 100 psi of air being supplied to it.
Air gate is opening when it should be closing and vice versa.	<ol style="list-style-type: none"> 1. Air lines to the air gate are reversed. 	<ol style="list-style-type: none"> 1. Exchange air line for the proper solenoid on the back of the solenoid bank.
Diverter is leaking seed through bypass side while in TREAT mode of operation.	<ol style="list-style-type: none"> 1. Too low of air pressure to actuate the diverter. 2. An obstruction in the diverter is stopping correct placement of the diverter plate. 	<ol style="list-style-type: none"> 1. Ensure that at least 100 psi of air pressure is present at the diverter. 2. Remove obstruction.
Solenoids are making a buzzing sound when air gates are actuated.	<ol style="list-style-type: none"> 1. Moisture in the air system. 2. Electric actuator on solenoid bank may be faulty. 	<ol style="list-style-type: none"> 1. Remove moisture from the air lines. 2. Replace the electronic actuator on the solenoid.
The touch screen has warning triangles on each button.	<ol style="list-style-type: none"> 1. The bin site PLC may be off. 	<ol style="list-style-type: none"> 1. Ensure that the bin site control panel has power to it, is ON and that all of the breakers inside the panel are on as well.
Conveyor will not start in HAND or AUTO mode.	<ol style="list-style-type: none"> 1. Conveyor motor starter is tripped. 2. Conveyor is clogged. 	<ol style="list-style-type: none"> 1. Reset motor starter. 2. Remove obstruction or debris.

SYSTEM ALARMS - FAULTS

Alarm - Fault	Possible Cause	Solution
Weigh Hopper over Max weight	<ol style="list-style-type: none"> 1. The current weight in the Weigh Hopper is above the number entered into the maximum scale weight in the Utilities screen. 	<ol style="list-style-type: none"> 1. Verify the number entered into the maximum scale weight box is correct. If yes, then recalibrate and rerun system.
Bin Site SURGE SUPPRESSOR-FAILED!!!	<ol style="list-style-type: none"> 1. L1 of the Surge protector will no longer protect the electrical panel against voltage surges. 	<ol style="list-style-type: none"> 1. Replace the Surge Protector.
Conv # Belt/Encoder Fault	<ol style="list-style-type: none"> 1. Conveyor belt is slipping. 2. Conveyor Speed encoder is not working correctly. 	<ol style="list-style-type: none"> 1. Tighten and adjust the Conveyor belt as necessary. 2. Verify that sensor is tight to shaft and wiring is correct. If yes to both, then replace sensor.
Conveyor #1 Motor Fault	<ol style="list-style-type: none"> 1. Conveyor #1 motor auxiliary contact was not sensed after being energized to run. 2. Conveyor #1 motor has been shutdown while in Auto mode of operation. 	<ol style="list-style-type: none"> 1. Verify that the motor starter has power, is turned on and that the overload is not tripped. 2. Verify that the Conveyor #1 was not turned OFF while the system was in Auto mode of operation.
Conveyor #2 Motor Fault	<ol style="list-style-type: none"> 1. Conveyor #2 motor auxiliary contact was not sensed after being energized to run. 2. Conveyor #2 motor has been shutdown while in Auto mode of operation. 	<ol style="list-style-type: none"> 1. Verify that the motor starter has power, is turned on and that the overload is not tripped. 2. Verify that the Conveyor #2 was not turned OFF while the system was in Auto mode of operation.
Conveyor #3 Motor Fault	<ol style="list-style-type: none"> 1. Conveyor #3 motor auxiliary contact was not sensed after being energized to run. 2. Conveyor #3 motor has been shutdown while in Auto mode of operation. 	<ol style="list-style-type: none"> 1. Verify that the motor starter has power, is turned on and that the overload is not tripped. 2. Verify that the Conveyor #3 was not turned OFF while the system was in Auto mode of operation.

SYSTEM ALARMS - FAULTS

Alarm - Fault	Possible Cause	Solution
Conveyor #4 Motor Fault	<ol style="list-style-type: none"> 1. Conveyor #4 motor auxiliary contact was not sensed after being energized to run. 	<ol style="list-style-type: none"> 1. Verify that the motor starter has power and is turned on.
Weigh Hopper Discharge Gate Fault	<ol style="list-style-type: none"> 1. OPEN/CLOSE slide gate sensor is not positioned properly. 2. OPEN/CLOSE slide gate solenoid failed to actuate. 	<ol style="list-style-type: none"> 1. Verify that the OPEN/CLOSE slide gate sensor is properly positioned. 2. Check air supply and signal to solenoid.
Bin Site Batch Overweight Alarm	<ol style="list-style-type: none"> 1. Hopper received more weight than called. 2. Hopper scale calibration is off. 	<ol style="list-style-type: none"> 1. Recalibrate scale with new run.

SYSTEM MESSAGES

The table below provides a general description of all the system messages that could occur. When a warning condition is detected, a window will appear (below) notifying the operator that the system will not start because of a certain condition. When the condition has been corrected, the START SCALE FILL FROM BIN button can be pressed to start the system.

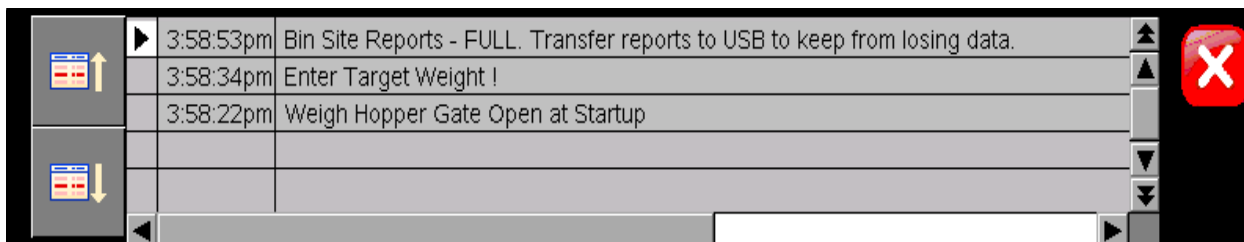

Message
Target weight too small.
Scale communications errors
Target weight larger than max hopper weight.
Weight hopper discharge valve not in auto.
Weigh hopper gate open at startup

**SECTION
E-3**

TRI - FLO ® TROUBLESHOOTING

TROUBLESHOOTING

Below is a table describing the most frequent problems and solutions with the USC Tri - Flo ® bin site system. For further assistance, contact USC at (785) 431-7900.

Problem	Possible cause	Solution
Tri - Flo ® : Minimum flow rate alarm.	1. Running too low capacity.	1. Adjust your air gates or manual gates.
Tri - Flo ® : Indicator weight shows two pounds in bin after run.	1. Tri - Flo ® did not empty completely.	1. Open gates on the Tri - Flo ® and zero scales.
Tri - Flo ® : Scale will not zero out.	1. Scale is in filing mode. 2. Scale is to far out of range.	1. Exit filling mode then end run. Needs to be in shipping mode. 2. Recalibrate scale
Tri - Flo ® : Even when all three scales are zeroed on Batch, the next batch gives a negative number on one of the hoppers with an overweight Alarm.	1. Tri - Flo ® was not emptied before zeroed. 2. Wind drafts. 3. Hoppers are touching.	1. Open gates and zero scale. 2. Close doors. 3. Loosen the four mounting bolts enough to be able to move the hopper. Make the gap on both sides of the hopper as even as possible.
Tri - Flo ® : If there are five pounds or less in the hopper, the system will not empty hopper.	1. Scale heel weight has not been reached.	1. Open and close the gate hopper.
System is not consistently calibrating correctly.	1. Bin slides gates or manual gates have been moved. 2. Underbin conveyor belt is slipping. 3. Bin slide gate is not consistently opening to the same point. 4. The operator is pressing the CANCEL SCALE FILL button before the run ends. 5. System is being paused during the run.	1. Ensure that the slide gate collar and manual gate is locked into place. Then recalibrate. 2. Tighten the underbin conveyor belt. 3. Check for any obstruction that may be restricting the movement of the slide gate. 4. Allow the system to shutdown on its own. 5. Make another run without pausing system.

TROUBLESHOOTING

Problem	Possible Cause	Solution
System calibration for currently selected bin is incorrect.	<ol style="list-style-type: none"> 1. System is too far out of calibration to recalibrate automatically. 	<ol style="list-style-type: none"> 1. Recalibrate the system. (see page 128)
Weight display not reading steady (Bouncing)	<ol style="list-style-type: none"> 1. Wind drafts. 2. Bad load cell. 3. Poor grounding. 	<ol style="list-style-type: none"> 1. Close doors. 2. Replace load cell. 3. Check grounding and ensure that it meets all area codes.
Scale is reading incorrect weight.	<ol style="list-style-type: none"> 1. Something is touching the scale. 2. Scale needs recalibrated. 	<ol style="list-style-type: none"> 1. Ensure that the area around the scale is clean and that nothing is leaning on or resting on the hopper. 2. Zero scale. If still incorrect, have a professional scale technician recalibrate the scale.
No Tri - Flo ® slide gates will open or close when their corresponding button is pressed on the touch screen.	<ol style="list-style-type: none"> 1. No air or not enough air is being supplied to the air regulator / filter on the frame cross member. 2. The Tri - Flo ® PLC may be off. 	<ol style="list-style-type: none"> 1. Ensure that at least 100 psi of air is being supplied to the regulator and it is adjusted for a minimum output of 45 PSI. Also, check to see that the filter is clean and no water has built up above the maximum allowed line. 2. Ensure that the Tri - Flo ® control panel has power to it, is ON and that all of the breakers inside the panel are ON as well.
No bin slide gates will open or close when their corresponding button is pressed on the touch screen.	<ol style="list-style-type: none"> 1. No air or not enough air is being supplied to the solenoid bank on the side of the bin site control panel. 2. The bin site PLC may be off. 	<ol style="list-style-type: none"> 1. Ensure that at least 100 psi of air is being supplied to the solenoid bank. 2. Ensure that the bin site control panel has power to it, is ON and that all of the breakers inside the panel are ON as well.
Air gate is opening when it should be closing and vice versa.	<ol style="list-style-type: none"> 1. Air lines to the air gate are reversed. 	<ol style="list-style-type: none"> 1. Exchange air line for the proper solenoid on the back of the solenoid bank.

TROUBLESHOOTING

Problem	Possible Cause	Solution
Air gate will not close fully.	<ol style="list-style-type: none"> 1. Something is obstructing the air gate from closing. 2. Air pressure to the gate is not strong enough. 	<ol style="list-style-type: none"> 1. Remove obstruction. 2. Ensure that the bin slide gate has at least 100 psi of air being supplied to it. If it is a Tri - Flo ® slide gate it needs at least 45 PSI.
Diverter is leaking seed through bypass side while in TREAT mode of operation.	<ol style="list-style-type: none"> 1. Too low of air pressure to actuate the diverter. 2. An obstruction in the diverter is stopping correct placement of the diverter plate. 	<ol style="list-style-type: none"> 1. Ensure that at least 100 psi of air pressure is present at the diverter. 2. Remove obstruction.
Solenoids are making a buzzing sound when air gates are actuated.	<ol style="list-style-type: none"> 1. Moisture in the air system. 2. Electric actuator on solenoid bank may be faulty. 	<ol style="list-style-type: none"> 1. Remove moisture from the air lines. 2. Replace the electronic actuator on the solenoid.
The touch screen has warning triangles on each button.	<ol style="list-style-type: none"> 1. The bin site PLC may be off. 2. The Tri - Flo ® panel may be off. 	<ol style="list-style-type: none"> 1. Ensure that the bin site control panel has power to it, is ON and that all of the breakers inside the panel are ON as well. 2. Ensure that the Tri - Flo ® control panel has power to it, is ON and that all of the breakers inside the panel are ON as well.
Conveyor will not start in HAND or AUTO mode.	<ol style="list-style-type: none"> 1. Conveyor motor starter is tripped. 2. Conveyor is clogged. 	<ol style="list-style-type: none"> 1. Reset motor starter. 2. Remove obstruction or debris.

SYSTEM ALARMS - FAULTS

Alarm - Fault	Possible Cause	Solution
Tri-Flo inlet diverter limit switch 1 FAIL Tri-Flo inlet diverter limit switch 2 FAIL Tri-Flo inlet diverter limit switch 3 FAIL	<ol style="list-style-type: none"> 1. Limit switch out of adjustment 2. Inverter did not fully rotate to the next hopper. 3. Limit switch failed. 	<ol style="list-style-type: none"> 1. Check adjustment on limit switch. 2. Manually rotate diverter to determine the problem. 3. Replace limit switch.
Tri-Flo WH1 discharge valve alarm Tri-Flo WH2 discharge valve alarm Tri-Flo WH3 discharge valve alarm	<ol style="list-style-type: none"> 1. Air not on. 2. Limit switch out of adjustment. 	<ol style="list-style-type: none"> 1. Check to see if the main incoming air valve is open. 2. Adjust limit switch.
Tri-Flo WH1 high level Tri-Flo WH2 high level Tri-Flo WH3 high level	<ol style="list-style-type: none"> 1. Weigh hopper is over full. 	<ol style="list-style-type: none"> 1. Empty hopper manually or move seed away from limit switch paddles by hand. 2. Run Cleanout.
Tri-Flo WH inlet diverter motor fault alarm	<ol style="list-style-type: none"> 1. Motor over voltage tripped. 	<ol style="list-style-type: none"> 1. Reset overload.
Tri-Flo surge suppressor – FAILED!!!	<ol style="list-style-type: none"> 1. L1 of the Surge protector will no longer protect the electrical panel against voltage surges. 	<ol style="list-style-type: none"> 1. Replace the Surge Protector.
Conveyor # Belt/Encoder Fault	<ol style="list-style-type: none"> 1. Conveyor belt is slipping. 2. Conveyor Speed encoder is not working correctly. 	<ol style="list-style-type: none"> 1. Tighten and adjust the Conveyor belt as necessary. 2. Verify that sensor is tight to shaft and wiring is correct. If yes to both, then replace sensor.

SYSTEM ALARMS - FAULTS

Alarm - Fault	Possible Cause	Solution
Conveyor #1 Motor Fault	<ol style="list-style-type: none"> 1. Conveyor #1 motor auxiliary contact was not sensed after being energized to run. 2. Conveyor #1 motor has been shutdown while in Auto mode of operation. 	<ol style="list-style-type: none"> 1. Verify that the motor starter has power, is turned on and that the overload is not tripped. 2. Verify that the Conveyor #1 was not turned OFF while the system was in Auto mode of operation.
Conveyor #2 Motor Fault	<ol style="list-style-type: none"> 1. Conveyor #2 motor auxiliary contact was not sensed after being energized to run. 2. Conveyor #2 motor has been shutdown while in Auto mode of operation. 	<ol style="list-style-type: none"> 1. Verify that the motor starter has power, is turned on and that the overload is not tripped. 2. Verify that the Conveyor #2 was not turned OFF while the system was in Auto mode of operation.
Conveyor #3 Motor Fault	<ol style="list-style-type: none"> 1. Conveyor #3 motor auxiliary contact was not sensed after being energized to run. 2. Conveyor #3 motor has been shutdown while in Auto mode of operation. 	<ol style="list-style-type: none"> 1. Verify that the motor starter has power, is turned on and that the overload is not tripped. 2. Verify that the Conveyor #3 was not turned OFF while the system was in Auto mode of operation.
Conveyor #4 Motor Fault	<ol style="list-style-type: none"> 1. Conveyor #4 motor auxiliary contact was not sensed after being energized to run. 	<ol style="list-style-type: none"> 1. Verify that the motor starter has power and is turned on.

SYSTEM MESSAGES

The table below provides a general description of all the system messages that could occur. When a warning condition is detected, a window will appear (below) notifying the operator that the system will not start because of a certain condition. When the condition has been corrected, the START SCALE FILL FROM BIN button can be pressed to start the system.

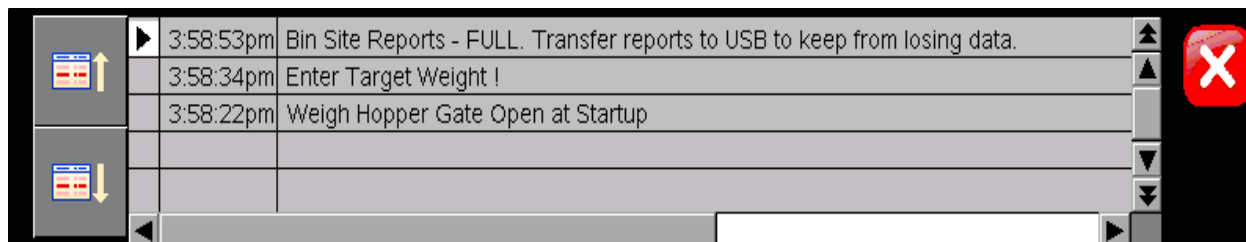

Message
Tri-Flo inlet diverter is not in auto
Tri-Flo WH 1 DCV is not in auto
Tri-Flo WH 2 DCV is not in auto
Tri-Flo WH 3 DCV is not in auto
Target weight too small
At least one of the Tri-flo scales is reading less than -5 LBS/KGS. Zero the scale(s)
Tri-Flo weigh hoppers are not empty, run clean out
Scale communications error
Bulk weigh ticket printer out of paper
Bulk weigh indicator not active. Check power and communication cables to the scale head & printer. Check printer paper.

**SECTION
F**

MECHANICAL DRAWINGS

MAIN CONTROL PANEL ASSEMBLY (13-12-0118)

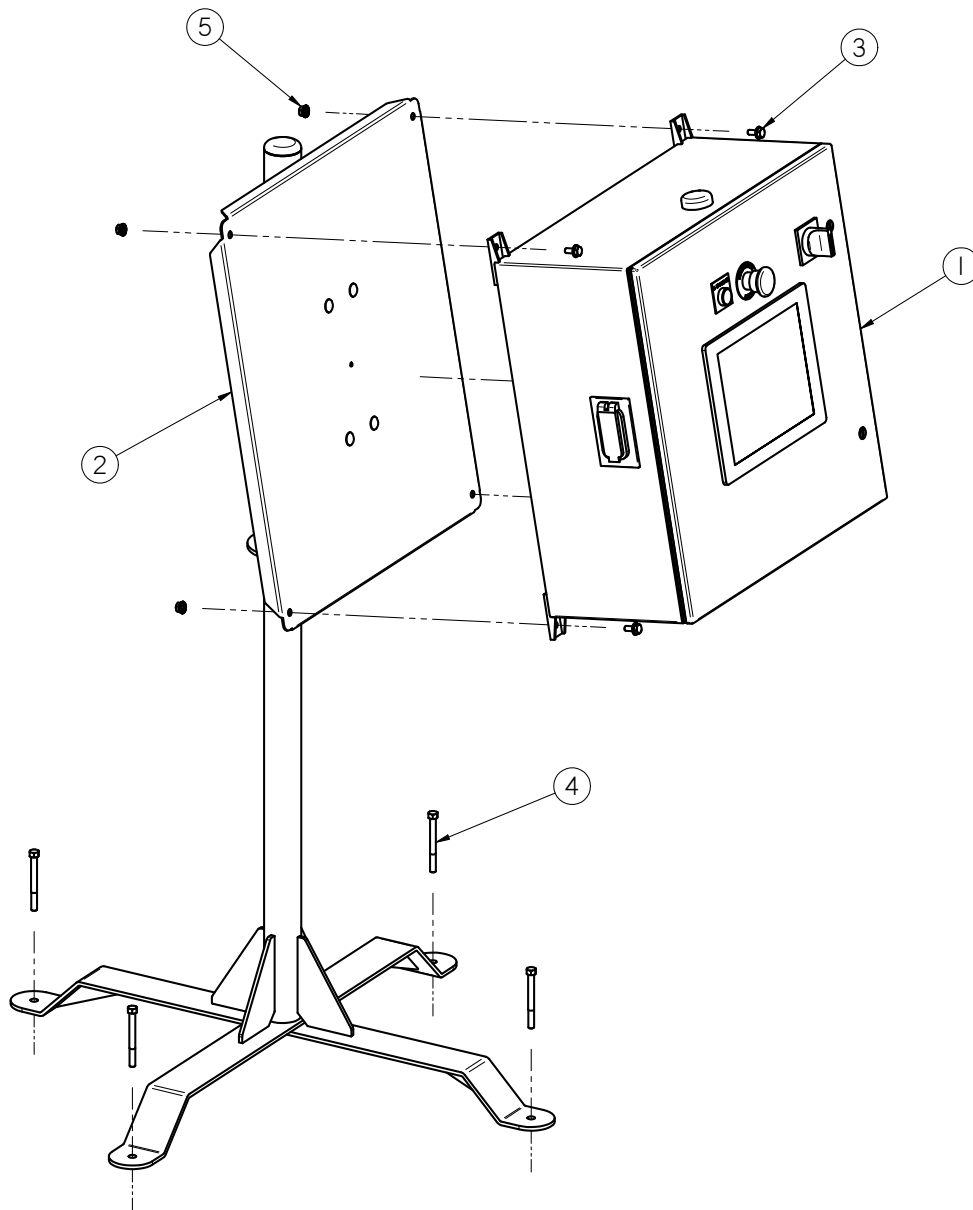

Item #	Part #	Description	Qty
1	03-12-0366	MAIN CONTROL PANEL U-TREAT	1
2	05-03-1471	ASSY PNL FRM 4PUMP SAP	1
3	06-01-0124	BOLT, FLG .375-16 UNC ZP GRADE 5; 3/4" LG	4
4	06-01-0220	BOLT .375-16 X 3.75 CONCRETE ZP	4
5	06-03-0033	NUT LOCK FLG .375-16 GR8	4

CSA COMPLIANT MAIN CONTROL PANEL ASSEMBLY (13-12-0119)

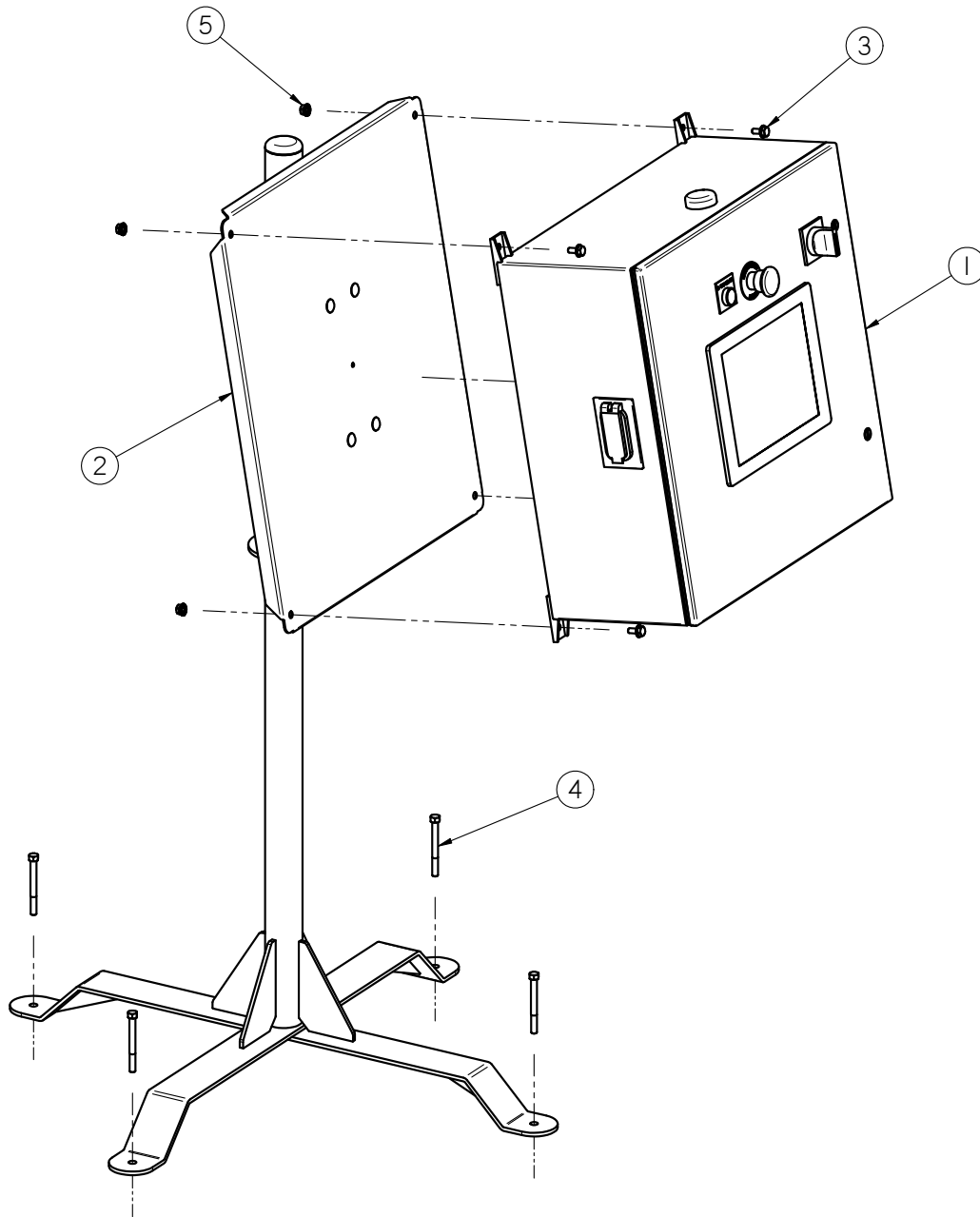

Item #	Part #	Description	Qty
1	03-12-0367	MAIN CONTROL PANEL U-TREAT	1
2	05-03-1471	ASSY PNL FRM 4PUMP SAP	1
3	06-01-0124	BOLT, FLG .375-16 UNC ZP GRADE 5; 3/4" LG	4
4	06-01-0220	BOLT .375-16 X 3.75 CONCRETE ZP	4
5	06-03-0033	NUT LOCK FLG .375-16 GR8	4

MAIN CONTROL PANEL WITH 4PC ASSEMBLY - 120V (13-12-0144)

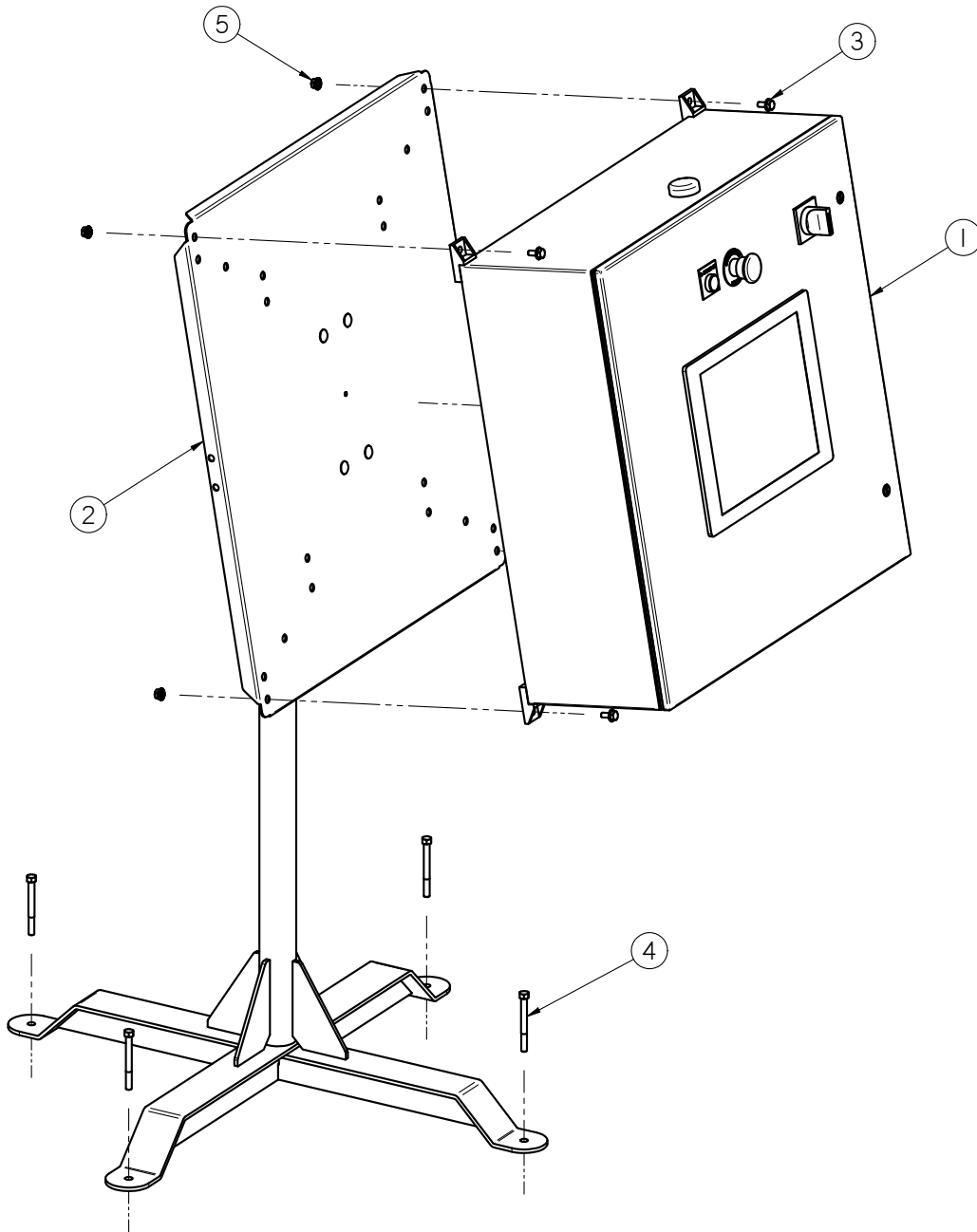

Item #	Part #	Description	Qty
1	03-12-0517	MAIN CONTROL PANEL WITH 4PC 120V	1
2	05-03-1658	ASSY PNL FRM 4PUMP SAP	1
3	06-01-0124	BOLT FLG .375-16 X .750 ZP GR5	4
4	06-01-0220	BOLT 3/8-16 CONC ANCHOR ZP 3.75	4
5	06-03-0014	NUT LOCK FLG .375-16 ZP GR5	4

MAIN CONTROL PANEL WITH 4PC ASSEMBLY - 220V (13-12-0146)

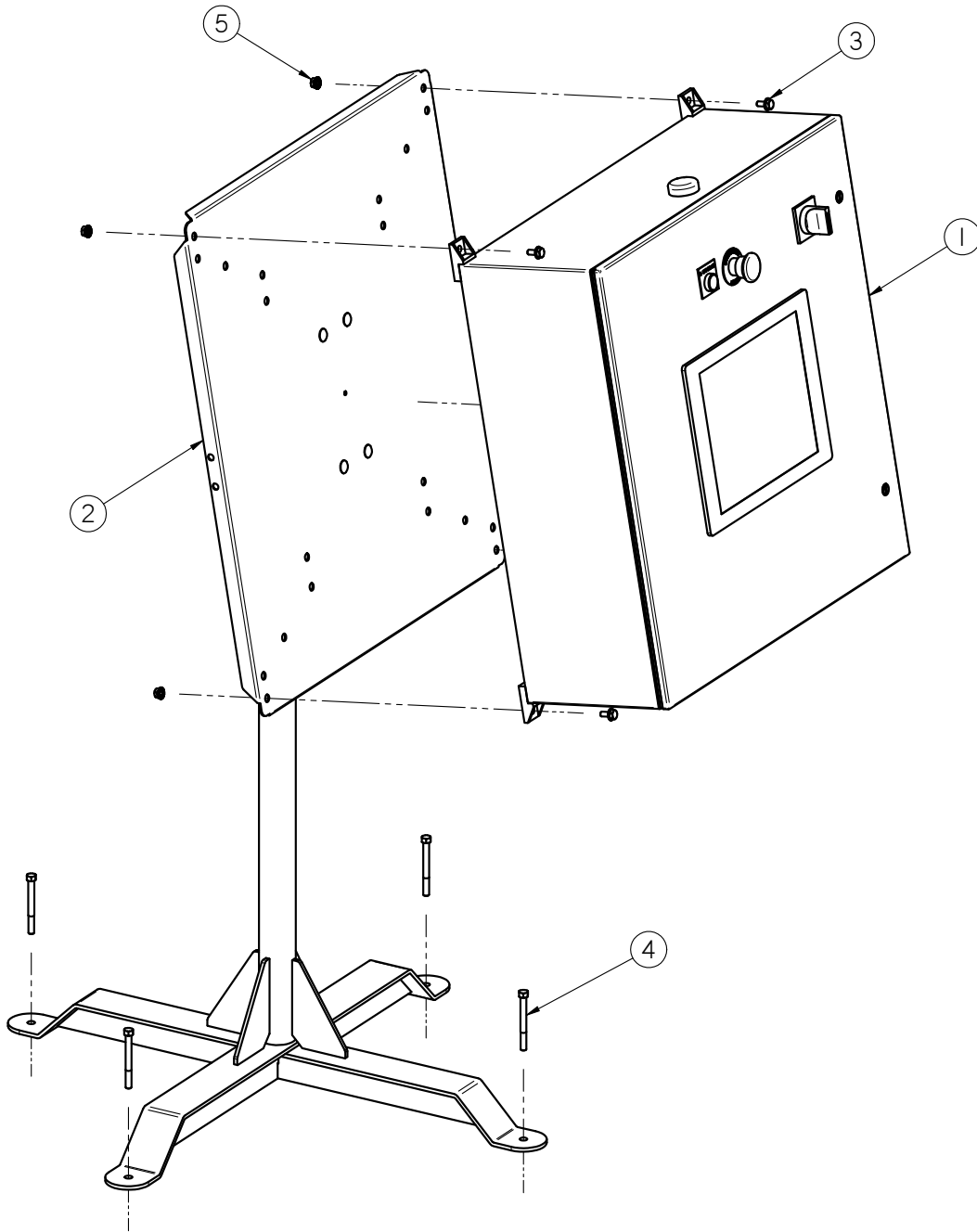

Item #	Part #	Description	Qty
1	03-12-0518	MAIN CONTROL PANEL WITH 4PC 220V	1
2	05-03-1658	ASSY PNL FRM 4PUMP SAP	1
3	06-01-0124	BOLT FLG .375-16 X .750 ZP GR5	4
4	06-01-0220	BOLT 3/8-16 CONC ANCHOR ZP 3.75	4
5	06-03-0014	NUT LOCK FLG .375-16 ZP GR5	4

ADJUSTABLE STAND ASSEMBLY (05-03-1471)

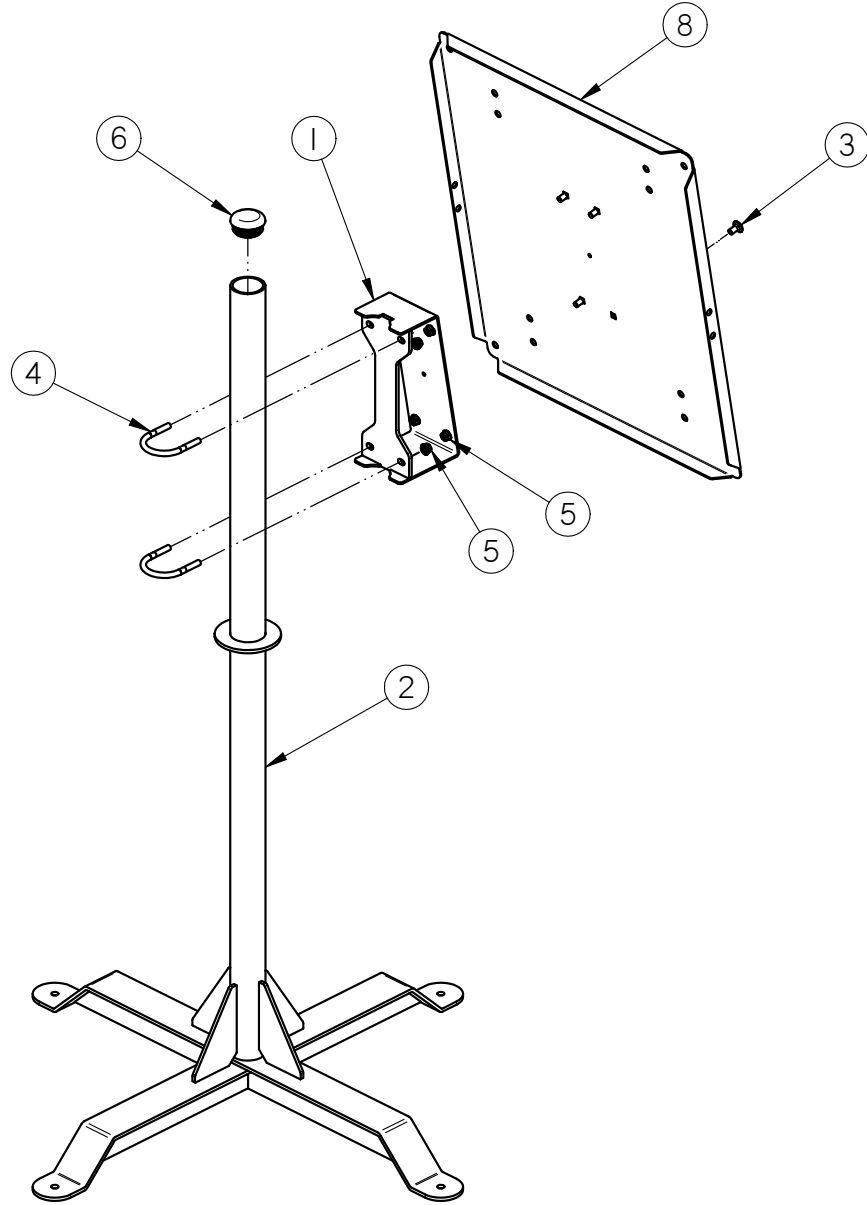

Item #	Part #	Description	Qty
1	05-03-1479	WDMT PNL ADJ	1
2	05-03-1545	WDMT PANEL STAND	1
3	06-01-0153	BOLT CRG .375-16X.750 ZP SHORT NECK	4
4	06-01-0287	BOLT U .375-16 X 2.50 X 3.125 ZP	2
5	06-03-0014	NUT LOCK FLG .375-16 ZP GR5	7
6	06-10-0056	PLUG TBG RD RIB POLY 2.38 X .156W	1
7	103651	PLT PNL MT	1

ADJUSTABLE STAND ASSEMBLY (05-03-1658)

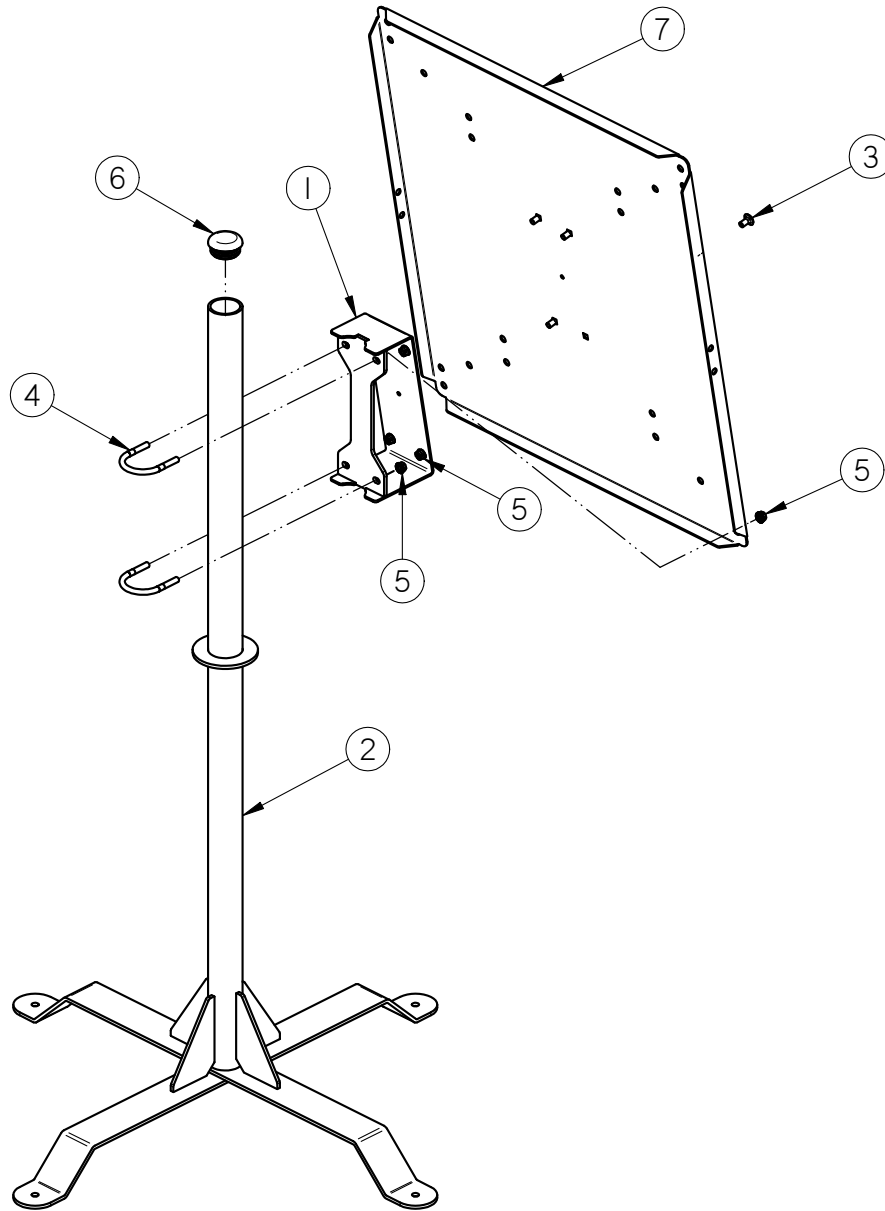

Item #	Part #	Description	Qty
1	05-03-1479	WDMT PNL ADJ	1
2	05-03-1545	WDMT PANEL STAND	1
3	06-01-0153	BOLT CRG .375-16X.750 ZP SHORT NECK	4
4	06-01-0287	BOLT U .375-16 X 2.50 X 3.125 ZP	2
5	06-03-0014	NUT LOCK FLG .375-16 ZP GR5	8
6	06-10-0056	PLUG TBG RD RIB POLY 2.38 X .156W	1
7	104D39	PLT PNL MT	1

NOTES:

USC LIMITED WARRANTY

SECTION G

USC, LLC, (Manufacturer) warrants its seed treating equipment as follows:

1. **Limited Warranty:** Manufacturer warrants that the Products sold hereunder will be free from defects in material and workmanship for a period of 18 months from date of shipment. If the Products do not conform to this Limited Warranty during the warranty period, Buyer shall notify Manufacturer in writing of the claimed defects and demonstrate to Manufacturer satisfaction that said defects are covered by this Limited Warranty. If the defects are properly reported to Manufacturer within the warranty period, and the defects are of such type and nature as to be covered by this warranty, Manufacturer shall, at its expense, furnish replacement Products or, at Manufacturer's option, replacement parts for the defective products. Shipping and installation of the replacement Products or replacement parts shall be at the Buyer's expense.
2. **Other Limits:** THE FOREGOING IS IN LIEU OF ALL OTHER WARRANTIES, EXPRESSED OR IMPLIED, INCLUDING BUT NOT LIMITED TO THE IMPLIED WARRANTIES OF MERCHANTABILITY AND FITNESS FOR A PARTICULAR PURPOSE. Manufacturer does not warrant against damages or defects arising from improper installation (where installation is by persons other than Manufacturer), against defects in products or components not manufactured by Manufacturer, or against damages resulting from such non-Manufacturer made products or components. Manufacturer passes on to the Buyer the warranty it received (if any) from the maker of such non-Manufacturer made products or components. This warranty also does not apply to Products upon which repairs and / or modifications have been effected or attempted by persons other than pursuant to written authorization by Manufacturer. This includes any welding on equipment which could damage electrical components. Manufacturer does not warrant against casualties or damages resulting from misuse and / or abuse of Products, improper storage or handling, acts of nature, effects of weather, including effects of weather due to outside storage, accidents, or damages incurred during transportation by common carrier.
3. **Exclusive Obligation:** THIS WARRANTY IS EXCLUSIVE. The sole and exclusive obligation of Manufacturer shall be to repair or replace the defective Products in the manner and for the period provided above. Manufacturer shall not have any other obligation with respect to the Products or any part thereof, whether based on contract, tort, strict liability or otherwise. Under no circumstances, whether based on this Limited Warranty or otherwise, shall Manufacturer be liable for lost profits, lost revenue, lost sales (whether direct or indirect damages), incidental, special, punitive, indirect or consequential damages.
4. **Other Statements:** Manufacturer's employees or representatives' oral or other written statements do not constitute warranties, shall not be relied upon by Buyer, and are not a part of the contract for sale or this limited warranty.
5. **Return Policy:** Approval is required prior to returning goods to Manufacturer. A restocking fee will apply.
6. **Entire Obligation:** This Limited Warranty states the entire obligation of Manufacturer with respect to the Products. If any part of this Limited Warranty is determined to be void or illegal, the remainder shall remain in full force and effect.

US / Canada Non-Exclusive 2016



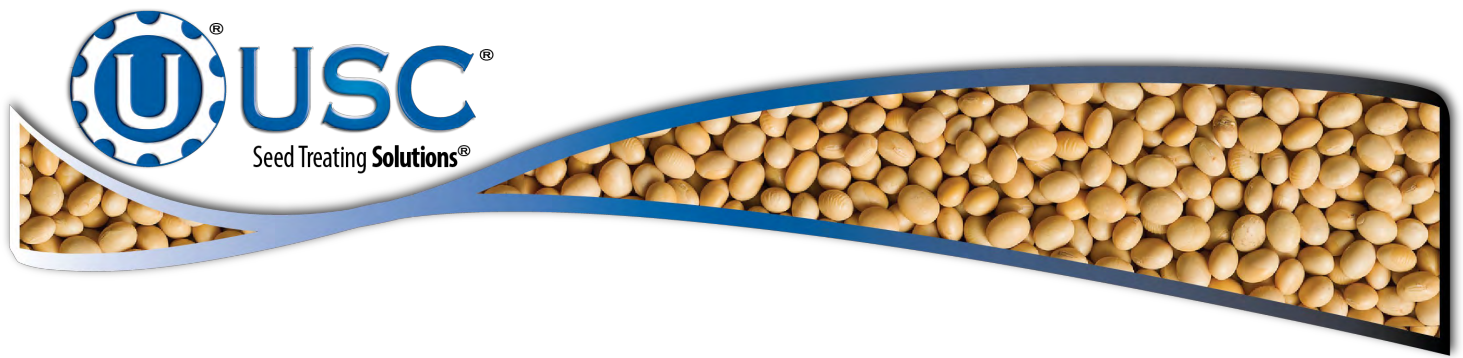

USC, LLC

2320 124th road

Sabetha, KS 66534

PHONE: (785) 431-7900

FAX: (785) 431-7950

EMAIL: sales-team@uscllc.com

WEB: www.uscllc.com

